

RSM610

CONTROL MODULE



Installation instructions

User manual

Safety requirements	4
Maintenance	4
Disposal	4
Standard delivery	5
Installing the device	5
Opening the module	5
Mounting dimensions	5
Dimensions drawing of enclosure	6
Sensor installation	7
Electrical connection	8
Terminal diagram	9
Mains connection	9
Sensor leads	10
Sensor terminal diagram	10
Data cable for DL bus	11
Terminal diagram, DL bus data cable	11
Bus load of DL sensors	11
CAN Bus network	12
Terminal diagram, CAN bus cable	12
Guidelines for the topology of a CAN network	12
Technical principles	12
Lightning protection	13
Examples of different network versions	13
Cable selection and network topology	15
Outputs	18
Terminal diagram, switching outputs	18
Terminal diagram for analogue outputs (0-10V / PWM)	19
Connection auxiliary relay HIREL-230V	20
HIREL-230V wiring diagram	20
Technical data RSM610	21
Tips on troubleshooting	22
Technical support	22
Troubleshooting in the CAN network	24
Information on the ECO-design Directive 2009/125/EC	24
User manual	26
LED status indicators	26
Status indicators at controller start	26
Operation via UVR16x2 or CAN-MTx2	27
User levels	27
Information displayed on the controller	28
Main menu display	29
Function overview display	30
Status line	34
Function overview	36
Changing values	37
The most important functions	39
Messages	47
Sensor and bus errors	47
Operation via C.M.I.	48
Changing a value	49

Safety requirements



All installation and wiring work on the controller must only be carried out in a zero volt state. The opening, connection and commissioning of the device may only be carried out by competent personnel. While doing so, they must observe all local safety requirements.

This device is state of the art and meets all necessary safety regulations. It may only be used in accordance with the technical data and the safety requirements and regulations listed below. When using the device, also observe the statutory and safety regulations apposite to the particular use. Any other use will automatically void all warranty rights.

- The device must only be installed in a **dry** interior room.
- It must be possible to isolate the controller from the mains using an omnipolar isolating facility (plug/socket or 2-pole isolator).
- Before starting installation or wiring work, the controller must be completely isolated from the mains and protected against reconnection. Never interchange the safety low voltage connections (e.g. sensor connections) with the 230 V connections. Destruction and life threatening voltages at the device and the connected sensors may occur.
- Solar thermal systems can become very hot. Consequently there is a risk of burns. Proceed with caution when fitting temperature sensors.
- For safety reasons, the outputs should only be left in manual mode when testing. In this operating mode, no maximum temperatures or sensor functions are monitored.
- Safe operation is no longer possible if the controller or connected equipment exhibits visual damage, no longer functions or has been stored for lengthy periods in unsuitable conditions. If this is the case, disable the controller and equipment and secure against unintentional use.

Maintenance

If treated and used correctly, the device will not require any maintenance. Use a cloth moistened with mild alcohol (such as methylated spirits) to clean. Never use corrosive cleaning agents or solvents such as chloroethylene or trichloroethylene.

No components relevant to long term accuracy are subject to loading if the device is used correctly. Consequently long term drift is extremely low. The device therefore cannot be calibrated. Thus applying any compensation is impossible.

The design characteristics of the device must not be changed during repairs. Spare parts must correspond to the original spare parts and must be used in accordance with the build version.

Disposal

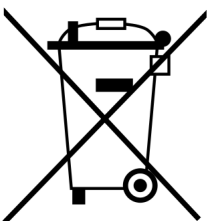

- Devices no longer in use or beyond a state of repair must be disposed of in an environmentally responsible manner by an authorised collection point. They must never be treated as ordinary household waste.
- We can undertake the environmentally responsible disposal of devices sold by the Technischen Alternative company upon request.
- Packaging material must be disposed of in an environmentally responsible manner.
- Incorrect disposal may result in considerable damage to the environment, as many of the materials used require professional handling.

Standard delivery

- RSM610 control module
- Power cable 1² / 0.75 m with earthed plug
- Installation instructions
- Accessories
 - Installation material
 - Enclosure lock
 - Locking clamp with strain relief

Installing the device

CAUTION: Always pull the mains plug before opening the enclosure!
Only work inside the module when the power supply is at zero volt.

Opening the module

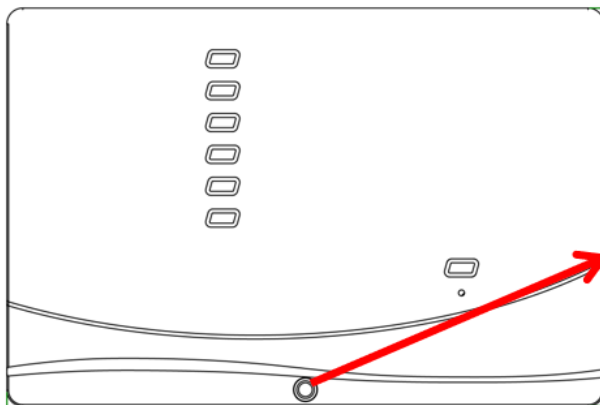

Unscrew the screws on the front and lift the cover.

The electronics are located in the cover. The connection to the terminals in the lower section of the enclosure is made by contact pins when the cover is put in place.

The lower section can be wall mounted through the slots provided (with the cable entries in the side facing down) or mounted on a top-hat rail (TS35 support rail as defined by the EN50022 standard).

Mounting dimensions

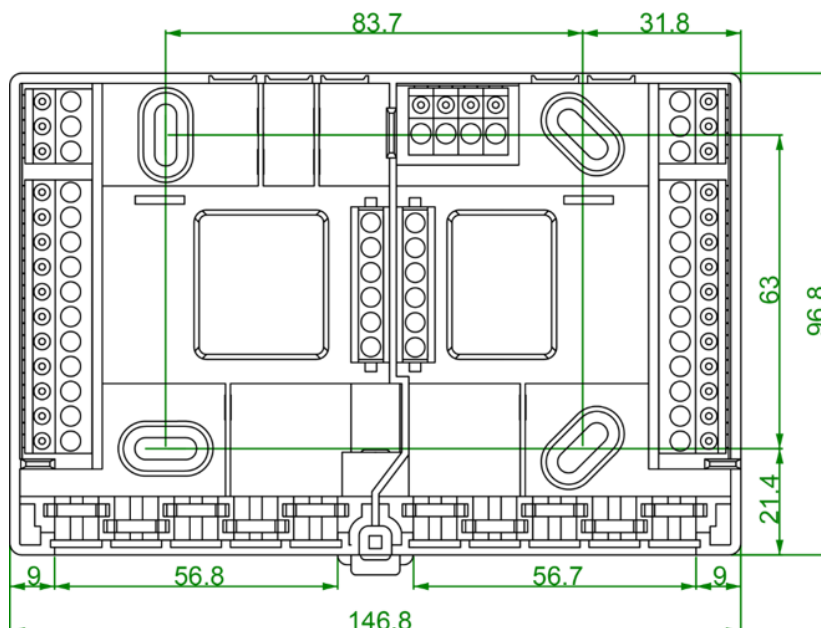

Dimensions drawing of enclosure

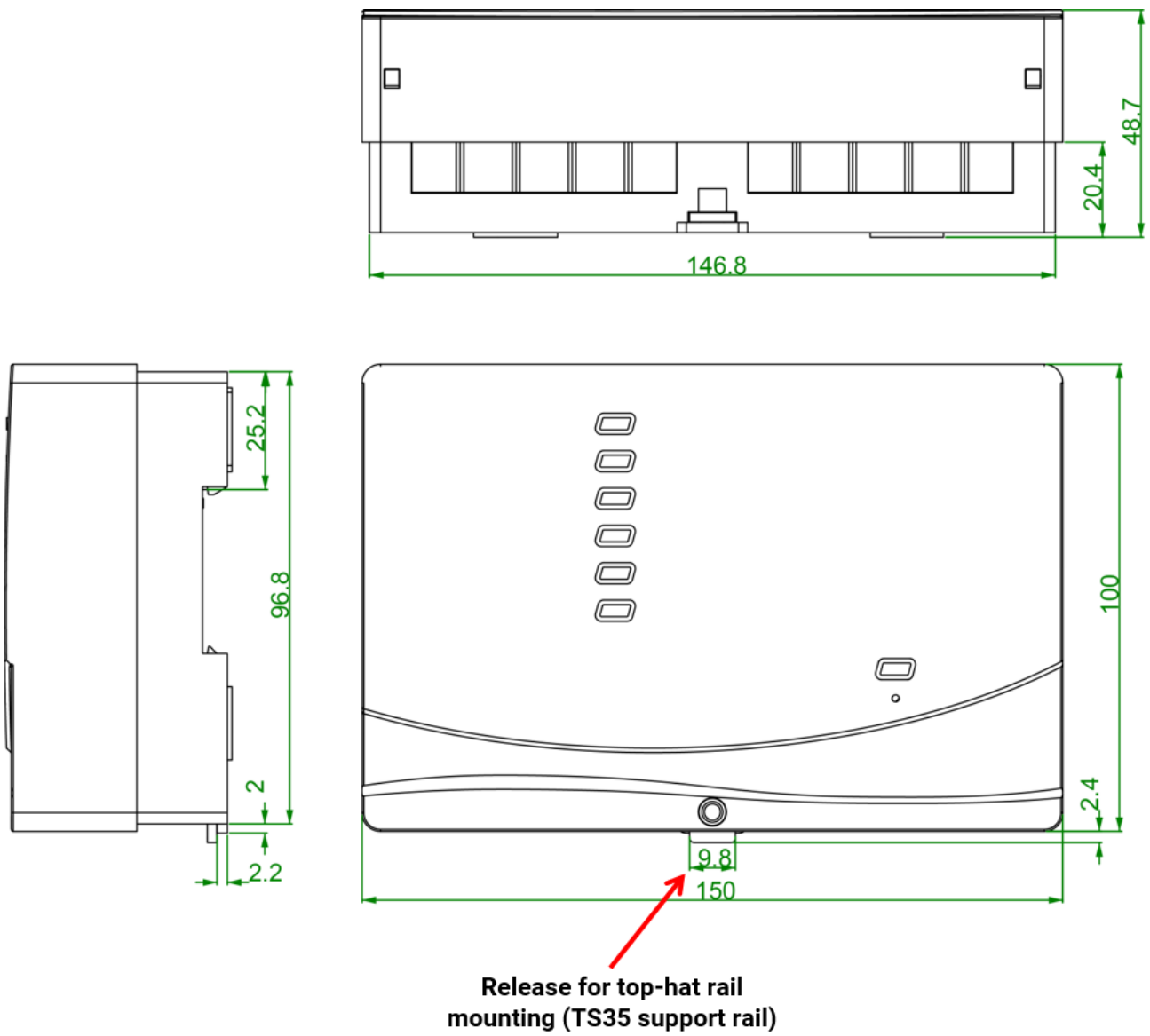

Sensor installation

Correct arrangement and installation of the sensors is extremely important for correct functioning of the system. To this end, also ensure that they are completely inserted in their sensor wells. The cable fittings provided serve as strain relief. When used outdoors, no water must be allowed to penetrate the sensor wells (**risk of frost**). The contact sensors must be insulated well to protect them from being influenced by the ambient temperature.

Fundamentally, sensors should not be exposed to moisture (such as condensation) since this can diffuse through the cast resin and damage the sensor. If this happens, heating the sensor to 90 °C for an hour may help. When using sensor wells in stainless steel cylinders or swimming pools, particular attention must be given to their **corrosion resistance**.

- **Collector sensor (grey lead with junction box)**: Either insert into a pipe which is brazed or riveted directly to the absorber and protrudes from the collector housing, or insert a tee into the flow manifold of the outermost collector into which the sensor well, together with the brass cable fitting (= protection against moisture), can be inserted; then insert the sensor. To protect against lightning damage, the junction box has a surge protection (voltage dependent resistor) which is clamped in parallel between the sensor and the extension cable.
- **Boiler sensor (boiler flow)**: This sensor is either inserted into a sensor well in the boiler or fitted to the flow line as close to the boiler as possible.
- **DHW cylinder sensor**: The sensor required for the solar thermal system should be used with a sensor well for finned tube heat exchangers just above the exchanger or, if integrated smooth tube heat exchangers are used, in the lower third of the exchanger or the exchanger's return outlet so that the sensor well protrudes into the heat exchanger tube. The sensor monitoring the heating of the DHW cylinder by the boiler is installed at a level corresponding to the amount of domestic hot water required during the heating season. The supplied cable fitting acts as strain relief. Installation **below** the associated coil or heat exchanger is not permissible **under any circumstances**.
- **Buffer sensor**: The sensor required for the solar thermal system is fitted in the lower section of the cylinder just **above** the solar indirect coil using the sensor well supplied. The supplied cable fitting acts as strain relief. As the reference sensor for the heating system hydraulics, it is recommended to insert the sensor into the sensor well between the centre and upper third of the buffer cylinder, or positioned against the cylinder wall underneath the insulation.
- **Pool sensor (swimming pool)**: Fit a tee into the suction line immediately on the pool outlet and insert the sensor with a sensor well. In the process, ensure the material used is corrosion-resistant. A further option would be to fit the sensor as a contact sensor with appropriate thermal insulation against ambient influences.
- **Contact sensor**: Use scroll springs, pipe clips, etc. to attach the contact sensor to the respective line. Ensure the material used is suitable (corrosion, temperature resistance, etc.). Then insulate the sensor thoroughly so that the pipe temperature is captured accurately and ambient temperatures cannot falsify the result.
- **DHW sensor: A rapid reaction** to changes in the water volume is extremely important when using the controller in systems that generate domestic hot water by means of an external heat exchanger and variable speed pump (freshwater module). Therefore fit the DHW sensor directly on the heat exchanger outlet. This **ultra-quick** sensor (special accessory, type **MSP** ...) should protrude into the output with the aid of a tee sealed in with an O-ring. The heat exchanger should be installed upright with the DHW outlet at the **top**.

- **Radiation sensor:** The **parallel** collector orientation is important in order to obtain a measurement that corresponds to the collector position. Consequently it should be secured to the sheet steel covering or adjacent to the collector on an extension of the mounting rail. To this end, the sensor casing has a blind hole that can be opened at any time. The sensor is also available as a wireless version.
- **Room sensor:** This sensor is intended for installation in the living space (reference room). Do not install the room sensor near a heat source or window. By simply replugging a jumper inside the sensor, each room sensor can also be used exclusively as a **remote adjuster** (no room temperature influence). It is only suitable for operation in dry rooms. The sensor is also available as a wireless version.
- **Outside temperature sensor:** This sensor is installed on the coldest wall (usually facing north) some two meters above the ground. Avoid temperature influences from nearby air shafts, open windows, cable ways, etc. It must not be subjected to direct insolation.

Electrical connection

This must only be carried out by a qualified electrician in accordance with the relevant local regulations.

Note: In line with regulations, the system must be equipped with protection against lightning (surge arrester). Sensor failures due to thunderstorms and static electricity are usually the result of missing or incorrect earthing or missing surge protection.

Caution: Only work inside the module when the power supply is at zero volt. Assembling the device with the power connected may result in damage.

Connect all sensors and pumps/valves as they are numbered in the respective program.

In the mains voltage range, fine wire cross-sections of 0.75 - 1.5 mm² are recommended, except for the supply cable.

A terminal strip is provided in the 230 V terminal box for connection of the earth conductor (PE). All cables can be fixed with a locking clamp (= strain relief) immediately after termination. Subsequently, side cutters are required to remove the locking clamps; therefore, more clamps than necessary are provided.

Terminal diagram

View of the lower enclosure section with terminals:

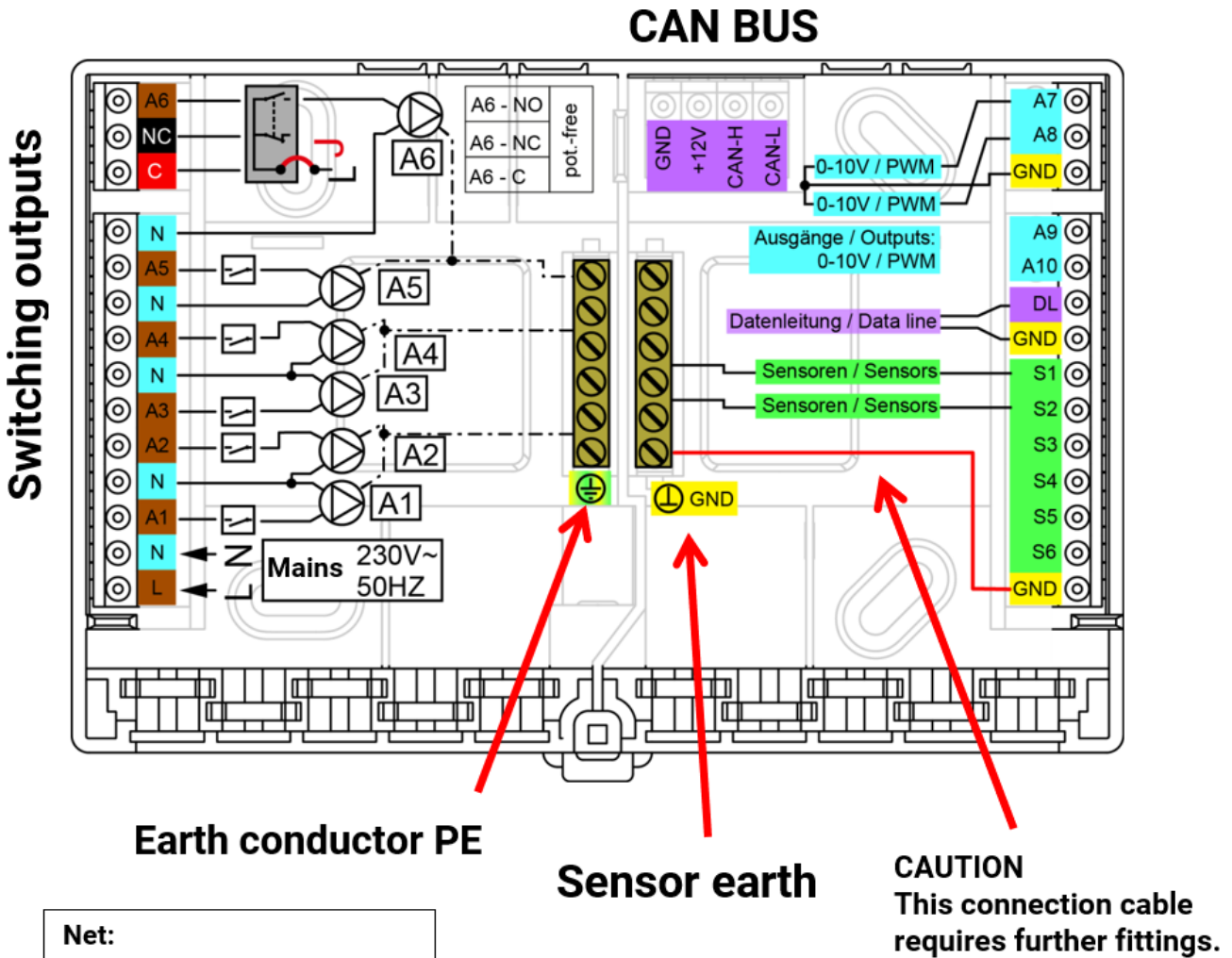

Net:	
L....	Phase conductor
N....	Neutral conductor
PE....	Earth conductor
Outputs:	
C....	Root C (A6)
A1 – A6....	N/O contact
NC....	N/C contact (A6)
N....	Neutral conductor

Mains connection

Power is supplied through a power supply unit integrated into the module. The mains connection must therefore be **230 V 50 Hz**. This is also the voltage conducted by the output relay. The integral power supply unit also supplies power to the CAN bus.

Sensor leads

Sensor terminal diagram

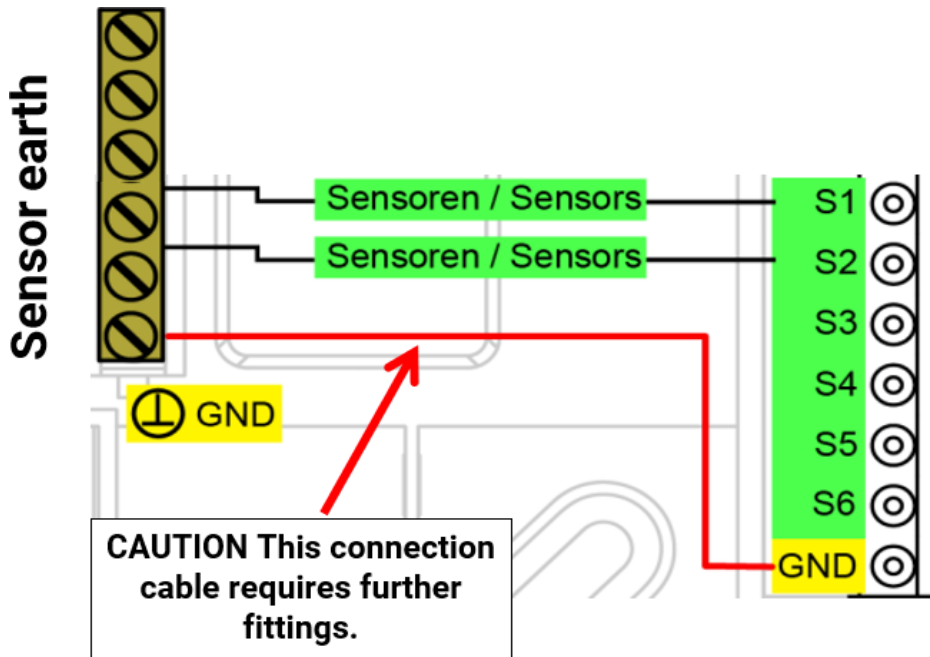

Sensors are always connected across the relevant sensor terminal (S1 – S6) and sensor earth (GND). There is an earth strip in the base. A connection to the GND terminal must be laid using this strip before the sensors are connected.

In order to prevent measurement fluctuations and ensure perfect signal transmission, sensor leads must not be subject to external negative influences through 230 V cables.

Never run sensor leads together with mains voltage cables in the same conduit.

When using non-screened cables, route sensor leads and 230 V cables either in separate cable conduits or with a **minimum clearance of 5 cm**.

Sensor leads for **PT100** or **PT500** sensors **must be screened**.

If screened cables are used, the screen must be connected to the sensor earth (GND)

All sensor leads with a cross-section of 0.5 mm² can be extended to up to 50 metres. With this lead length and a PT1000 temperature sensor, the measuring error is approximately +1 K. A correspondingly larger cross-section is required for longer leads or a lesser measuring error.

The connection between the sensor and the extension can be made by pushing heat shrink tubing (trimmed to 4 cm) over one core and twisting the **bare** wire ends. **Solder** the connection if one of the wire ends has been **tin-plated**.

Then push the heat shrink tubing over the connection and heat up carefully (e.g. with a lighter) until it sits tightly over the connection.

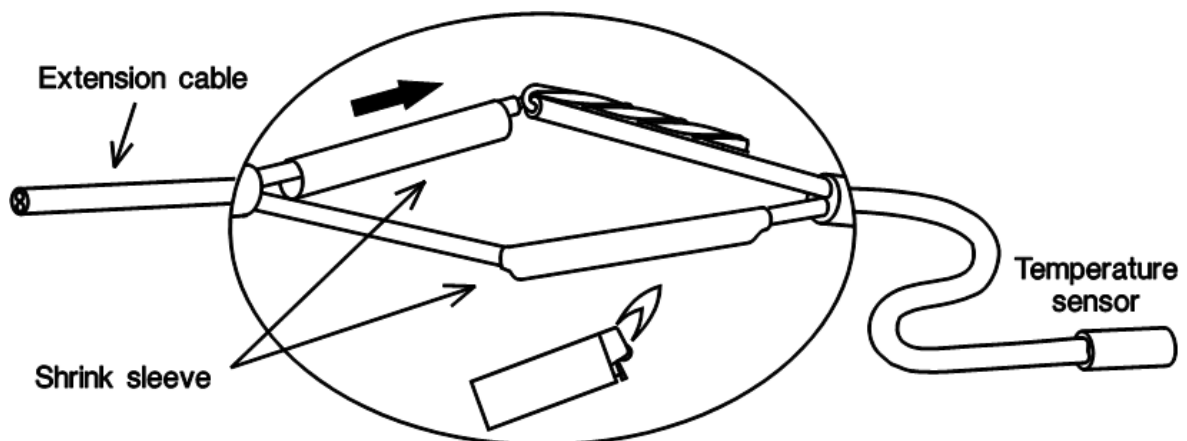

Data cable for DL bus

The DL BUS consists of just 2 wires: **DL** and **GND** (sensor earth). The DL BUS itself supplies the necessary power for the DL BUS sensors.

Cables can be routed with a star topology but also in serial formation (from one device to the next). Any cable with a cross-section of 0.75 mm², and measuring up to 30 m in length, can be used as a data link. For lengths greater than 30 m, the use of screened cables is recommended, which increases the reliable length of the cable to 100 m.

If screened cables are used, the screen must be connected to GND.

Long cable conduits routed closely next to each other for mains and data cables result in faults being induced into the data cables from the mains. We therefore recommend a minimum clearance of 20 cm between two cable conduits or the use of screened cables.

Use separate, screened cables when capturing data from two controllers with a single datalogger. Never run the data cable together with a CAN BUS cable in the same conduit.

Terminal diagram, DL bus data cable

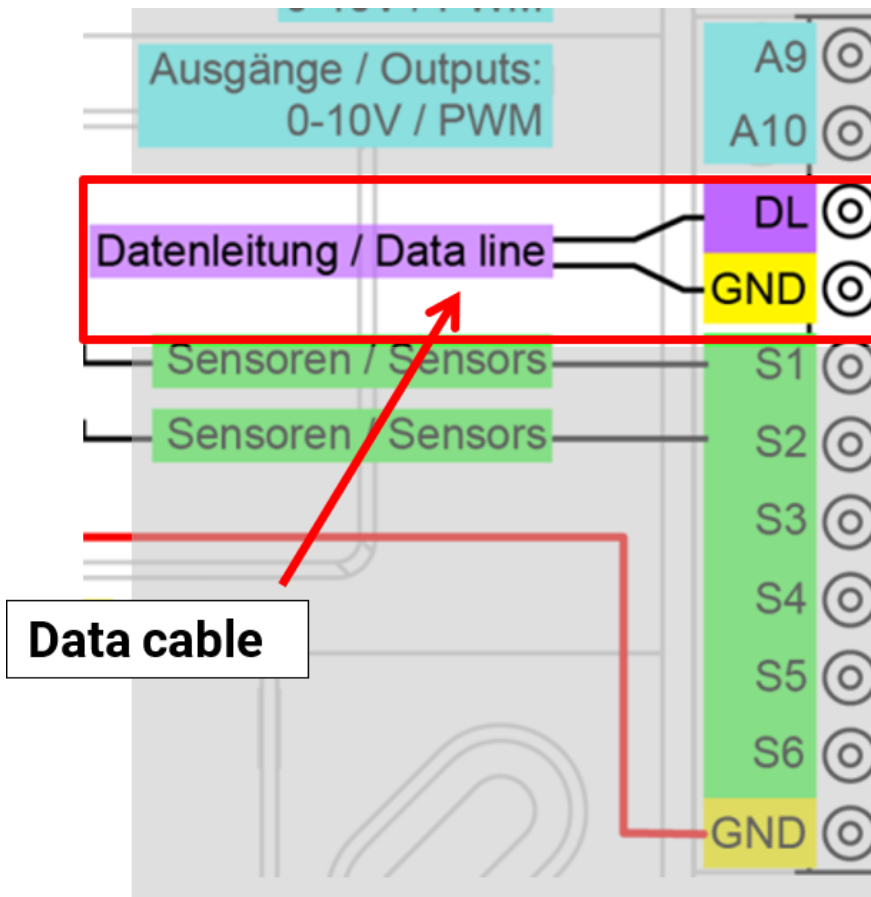

Bus load of DL sensors

A 2-pole cable provides **both** the power supply and the signal transfer from DL BUS sensors. An additional power supply by means of an external power supply unit (such as with the CAN BUS) is not possible.

Take the "**BUS load**" into consideration as sensors have a relatively high current demand:

The RSM610 module supplies the **total** BUS load. The BUS loads of the electronic sensors are listed in the technical data of the relevant sensors.

Example: The electronic sensor FTS4-50DL has a BUS load of **25 %**. Consequently up to four FTS4-50DL can be connected to the DL BUS.

CAN Bus network

Terminal diagram, CAN bus cable

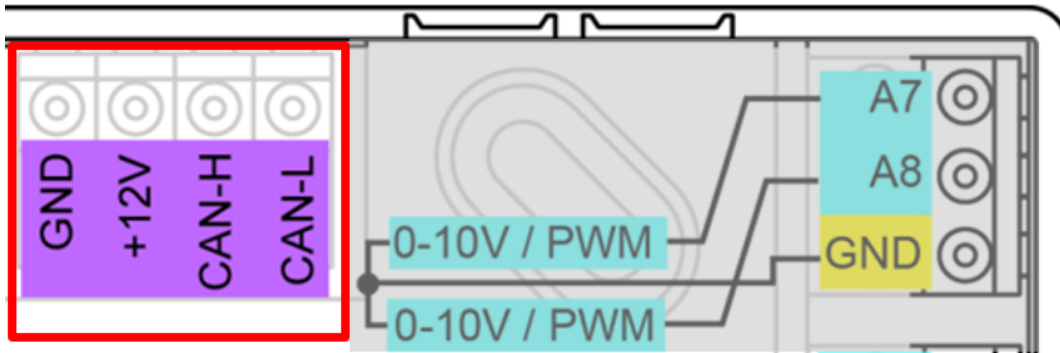

Guidelines for the topology of a CAN network

Technical principles

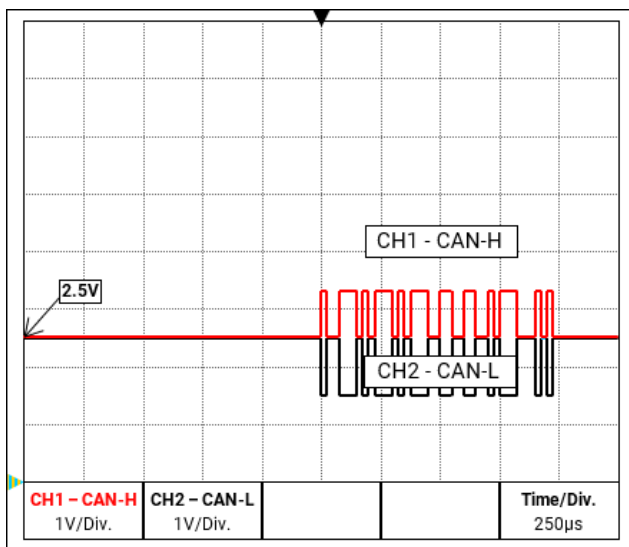

CAN-H and CAN-L data signals

The CAN BUS comprises the cables CAN-High, CAN-Low, GND and one +12 V supply cable for BUS components without their own power supply. The combined total load of all devices with 12 V and 24 V supply must not exceed 6 W.

Design CAN networks in a linear fashion and set a terminator at each network termination. This is ensured by the termination of the end devices.

In the case of larger networks (covering several buildings), problems can occur through electromagnetic interference and potential differences.

To avoid or to the greatest extent manage such problems, take the following measures:

- **Cable screening**

The BUS cable screen must be connected well at every node to provide continuity. For larger networks we recommend including the screen in the equipotential bonding, in line with the examples shown.

- **Equipotential bonding**

As low an ohm connection as possible to the earth potential is particularly important. Where cables enter buildings, ensure that the cable entries are in the same location where possible and that all are connected to the same equipotential bonding system ($S_{\text{ingle}}E_{\text{entry}}P_{\text{oint}}$ principle). The purpose is to create potentials that are as similar as possible, in order to achieve the smallest possible potential difference to adjacent lines in case one line suffers a voltage surge (lightning strike). Also ensure a corresponding clearance between the cable and lightning protection systems.

The equipotential bonding also has positive properties to counteract interferences emitted from linked cables.

- **Avoiding earth loops**

Where a bus cable is routed between several buildings, ensure that earth loops are avoided. The reason for this is that buildings actually have different potentials compared to the earth potential. An earth loop is created when connecting one cable screen in each building **directly** with the equipotential bonding system. In other words, a current flows from the higher to the lower potential.

For example, if lightning strikes near one of the buildings, the potential of that building will briefly be raised by several kV.

In this case, the equalizing current flows to earth via the bus screen and causes an extreme electromagnetic input which can result in the destruction of the bus components.

Lightning protection

Efficient lightning protection is highly dependent on good building earthing that meets the relevant regulations.

An external lightning protection system offers protection against a **direct** lightning strike.

In order to protect against voltage surges in the 230 V mains supply cable (**indirect** lightning strike), appropriate lightning conductors and surge arresters compliant with local regulations must be fitted in the upstream distribution systems.

In order to protect the individual components of a CAN network against **indirect** lightning strike, we recommend the use of surge arresters specifically developed for bus systems.

Example: CAN bus surge arresters CAN-UES from Technische Alternative
Gas discharge arrester for indirect earthing EPCOS N81-A90X

Examples of different network versions

Key to symbols:

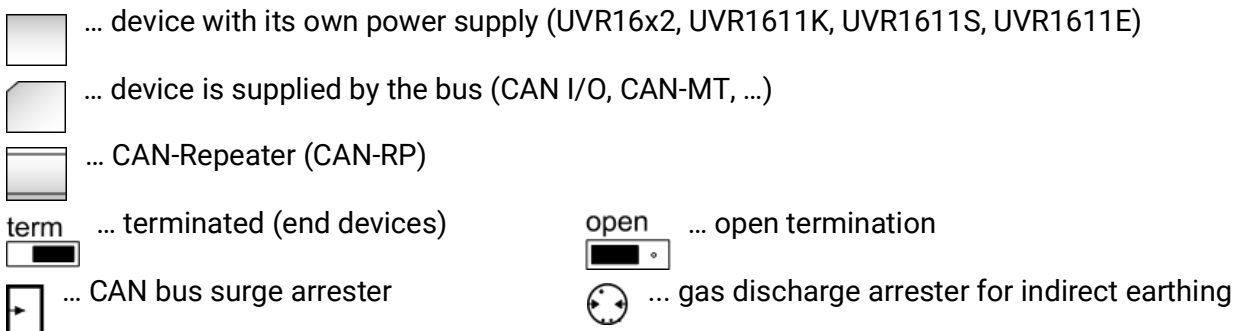

„Small“ network (within one building):

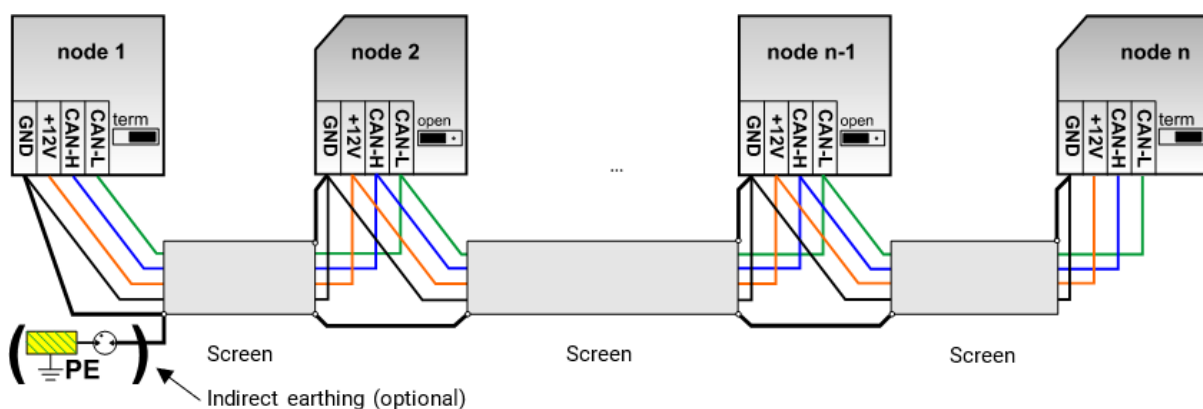

Max. cable length: 1000 m at 50 kbit/s

The screen must be continued at each network node and be connected to the device earth (GND). The screen earthing or GND must only be implemented **indirectly** via a gas discharge arrester.

Ensure that no unintentional **direct** connection of earth or screen and the earth potential is created (e.g. via sensors and the earthed pipework).

Network (across several buildings) without CAN-Repeater CAN-RP:

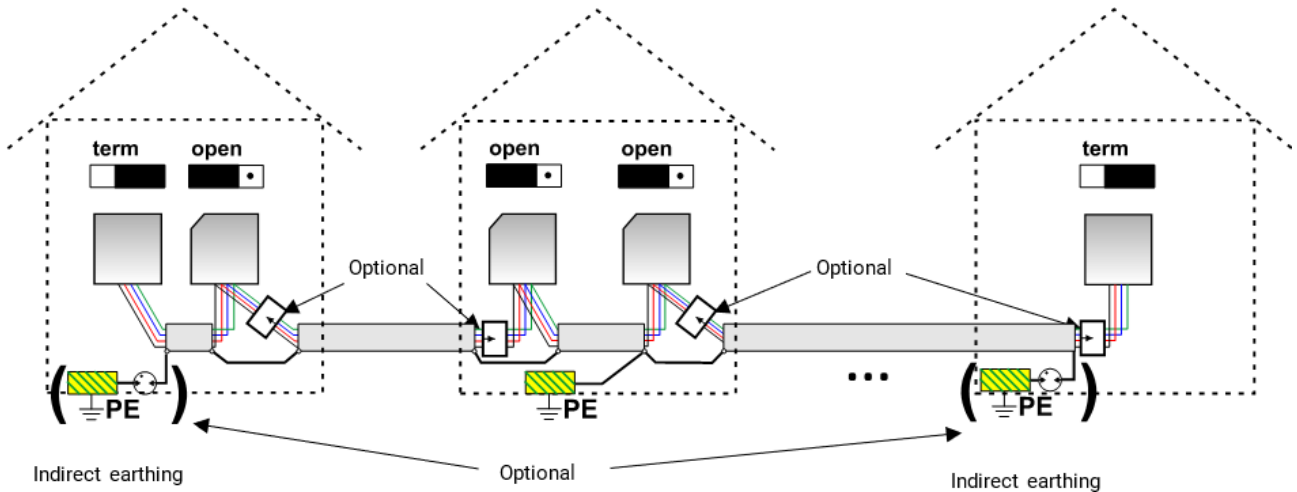

Max. cable length: 1000 m at 50 kbit/s

The screen must be continued at every network node and earthed at a **single** point, as close to the cable center as possible. We recommend earthing the screen **indirectly** in the other buildings using a gas discharge arrester. The screen is **not** connected with the earth (GND) of the devices.

Netzwerk (across several buildings) with CAN-Repeater CAN-RP:

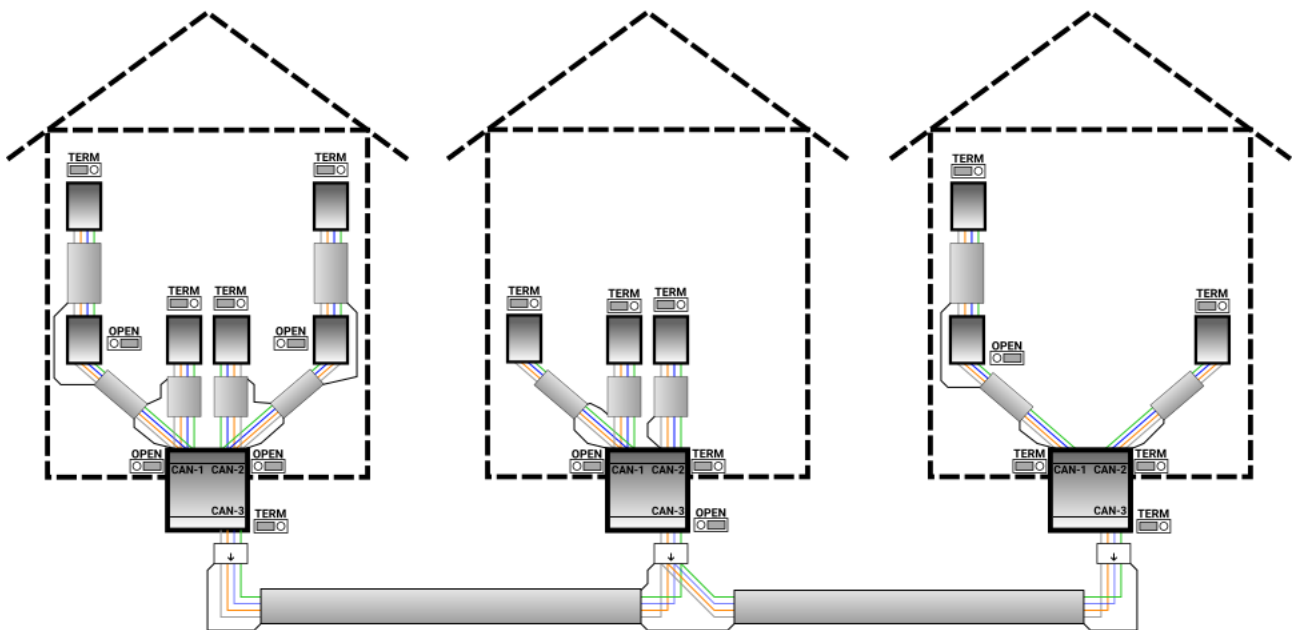

Maximum cable length: subject to the set Baud rate

The screen of the **disconnected** network is connected at each bus converter to CAN bus earth (GND). This screen must **not** be **directly** earthed.

Without CAN Bus surge arresters, this version only protects against potential differences **up to 1 kV**, therefore cannot be considered as lightning protection. In this case, the cable screen must be earthed at a **single** point between the CAN bus converters, as close to the cable centre as possible. We recommend earthing the screen **indirectly** in the other buildings using a gas discharge arrester.

A CAN bus converter is similar to a repeater. It receives CAN bus signals and passes them on. Each cable run on either side of the CAN bus converter must therefore be viewed as an independent CAN bus network.

Cable selection and network topology

Screened **twisted pairs** have proven useful in CANopen networks. These are cables with twisted pairs of conductors and a shared external screen. Such cables are relatively resistant to EMC interference and can still carry 50 kbit/s for up to 1000 m. The CANopen recommendations (CiA DR 303-1) for cable cross-sections are given in the table below.

Bus length [m]	Resistance in terms of length [mΩ/m]	Cross-section [mm ²]
0...40	70	0,25...0,34
40...300	< 60	0,34...0,60
300...600	< 40	0,50...0,60
600...1000	< 26	0,75...0,80

The maximum cable length also depends on the number of nodes [n] linked with the bus cable and the cable cross-section [mm²].

Cable cross-section [mm ²]	Maximum length [m]	
	n=32	n=63
0,25	200	170
0,50	360	310
0,75	550	470

Bus rate

In the CAN bus / CAN settings menu of the UVR16x2, the bus rate can be set to between 5 and 500 kbit/s, whereby lower bus rates enable longer cable networks. However, in this case, the cable cross-section must be increased accordingly.

The standard bus rate of the CAN network is 50 kbit/s (50 kBaud), which is specified for many CAN bus devices.

Important: All devices in the CAN bus network must have the **same** transfer rate in order to be able to communicate with each other.

Bus rate [kbit/s]	Maximum permissible total bus length [m]
5	10.000
10	5.000
20	2.500
50 (standard)	1.000
125	400
250	200
500	100

Recommendations

A 2x2-pole, screened twisted pair (twist CAN-L with CAN-H or +12 V with GND) with a cable cross-section of at least 0.5 mm² and a conductor-to-conductor capacity of no more than 60 pF/m and a nominal impedance of 120 ohms. The standard bus speed of the UVR16x2 is 50 kbit/s. This recommendation corresponds, for example, to cable type **Unitronic®-BUS CAN 2x2x0.5** supplied by **Lapp Kabel** for permanent installation **in buildings or conduits**. Theoretically this would enable a bus length of approx. 500 m to guarantee reliable transmission.

For **direct routing underground**, earth cable **2x2x0.5** mm² supplied by **HELUKABEL**, part no. 804269, or earth cable **2x2x0.75** mm² supplied by **Faber Kabel**, part no. 101465, would be suitable.

Wiring

A CAN BUS network should never have a **star topology**. Rather, the correct topology is a line from the first device (with terminator) to the second, third and so forth. The last bus device has the termination jumper again.

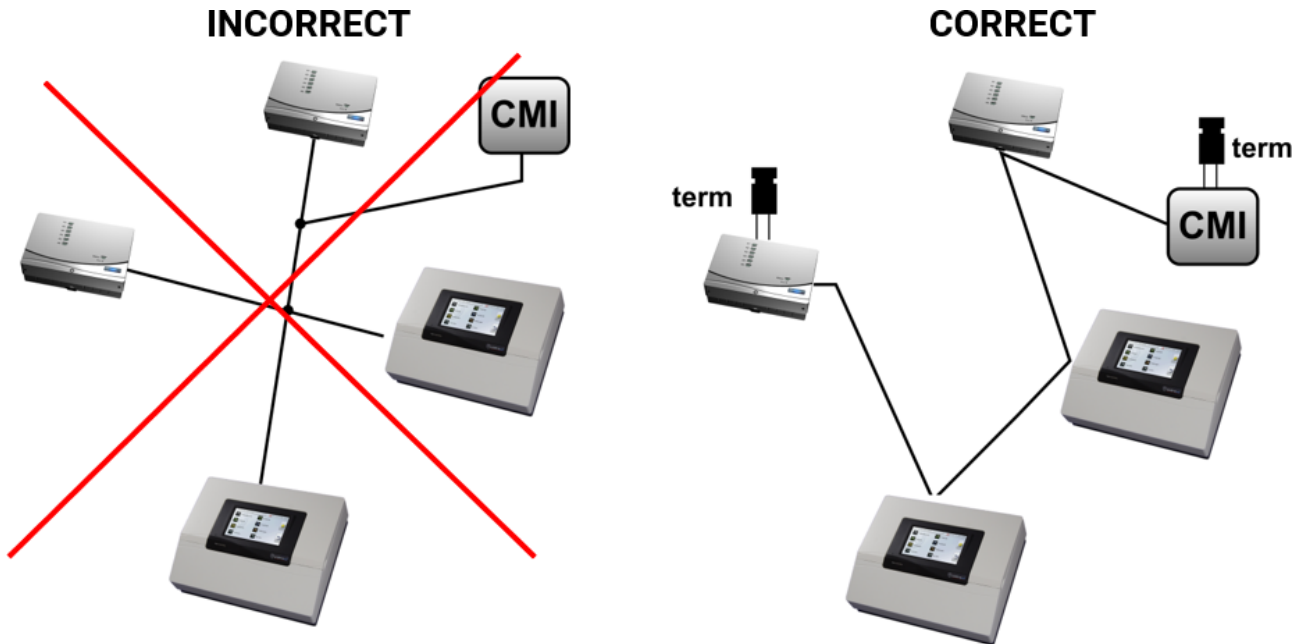

Example: Connection of three network nodes (NWN) with a 2x2-pole cable and **termination** of the terminal network nodes (network inside one building)

 terminated (termination resistor 120 Ohm)

 termination open

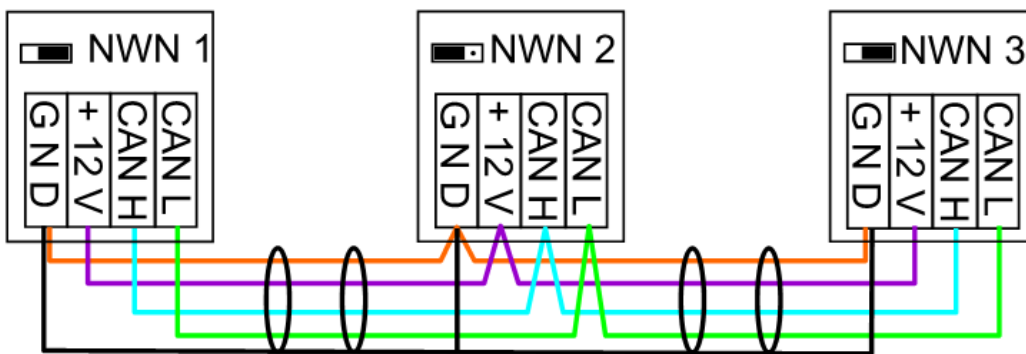

Each CAN network is to be provided with a 120 ohm BUS terminator at the first and last network subscriber (= **termination**). This is achieved with a plug-in jumper **at the back of the controller**. Each CAN network therefore always has two terminators (one at each end). Branch cables or a star topology are not permissible for CAN wiring.

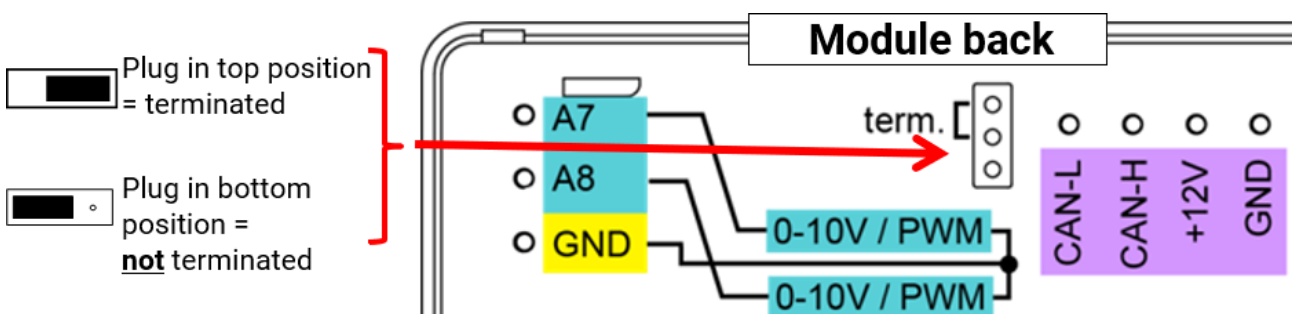

Branch cables

A CAN bus converter is used to provide reliable **long** branch cables. This means the branch cable is disconnected from the other CAN bus network and can be viewed as an independent CAN bus network.

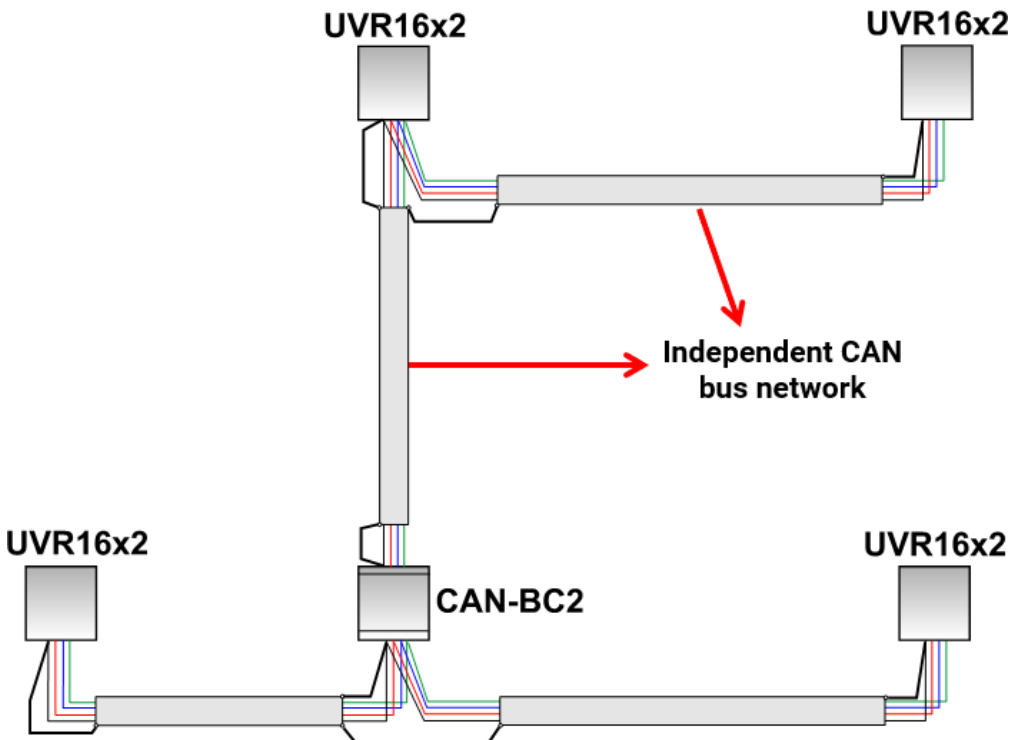

Trials at the factory have shown the following:

- 1) Branches with a star topology of up to 10 m will not impede transmission.
- 2) Up to a bus length of 250 m and a transfer rate of 50 kbit/s, data transfer works perfectly with a low number of CAN nodes and an inexpensive **J-Y(St)Y EIB KNX 2x2x0.8** KNX bus cable with a characteristic impedance of 75 to 90 ohm.
- 3) Up to a bus length of 150 m and with only a few nodes, the **CAT 5 24AWG** cable (typical Ethernet cable in PC networks) can be used.

Changing to cable types with different characteristic impedances is only permitted via signal separation through a CAN bus converter.

However, such networks do not comply with the recommended specification. Technische Alternative RT GmbH therefore cannot guarantee trouble-free operation if one of the three options listed above is applied.

Outputs

Terminal diagram, switching outputs

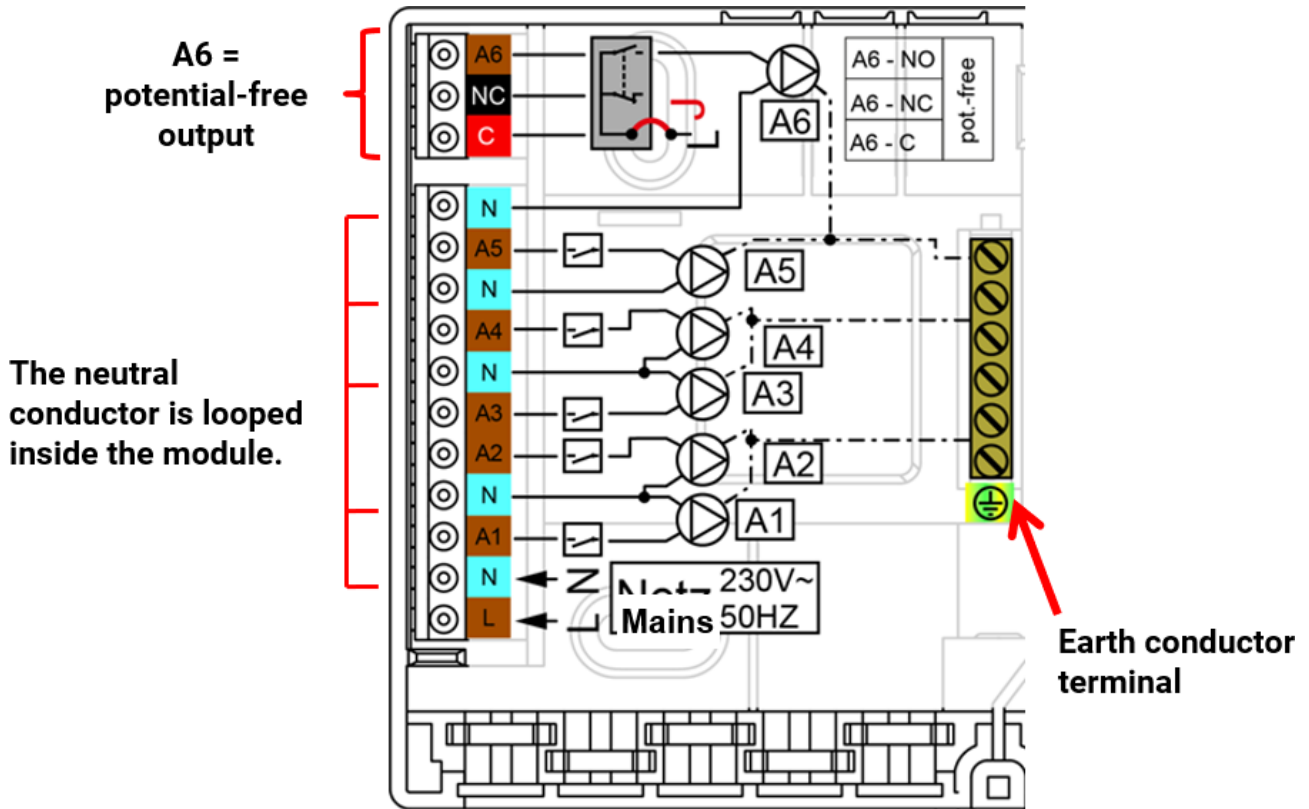

For maximum current load of the outputs, see the **technical data**.

Potential-free connection of output 6

By unplugging jumper **J**, output A6 can be rendered potential-free.

View of module back:

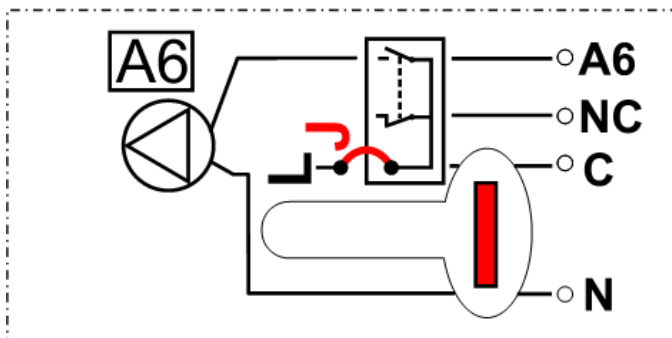

With jumper **J** plugged in, output 6 is **not** potential-free.

Example: Connecting a pump

- C (= L).... Phase conductor
- A6.... Normally open contact (N/O)
- NC.... Normally closed contact (N/C)

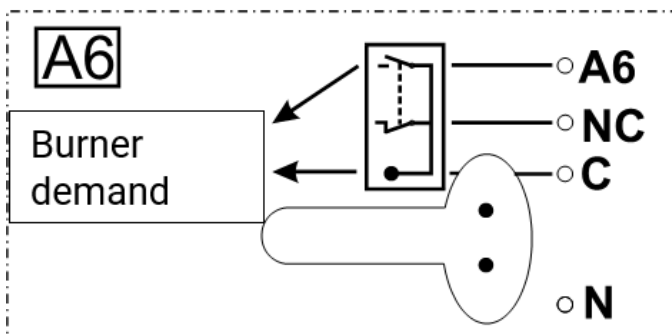

If the jumper is unplugged, output 6 is potential-free.

Example: Burner demand

- C.... Root C
- A6.... Normally open contact (N/O)
- NC.... Normally closed contact (N/C)

Terminal diagram for analogue outputs (0-10V / PWM)

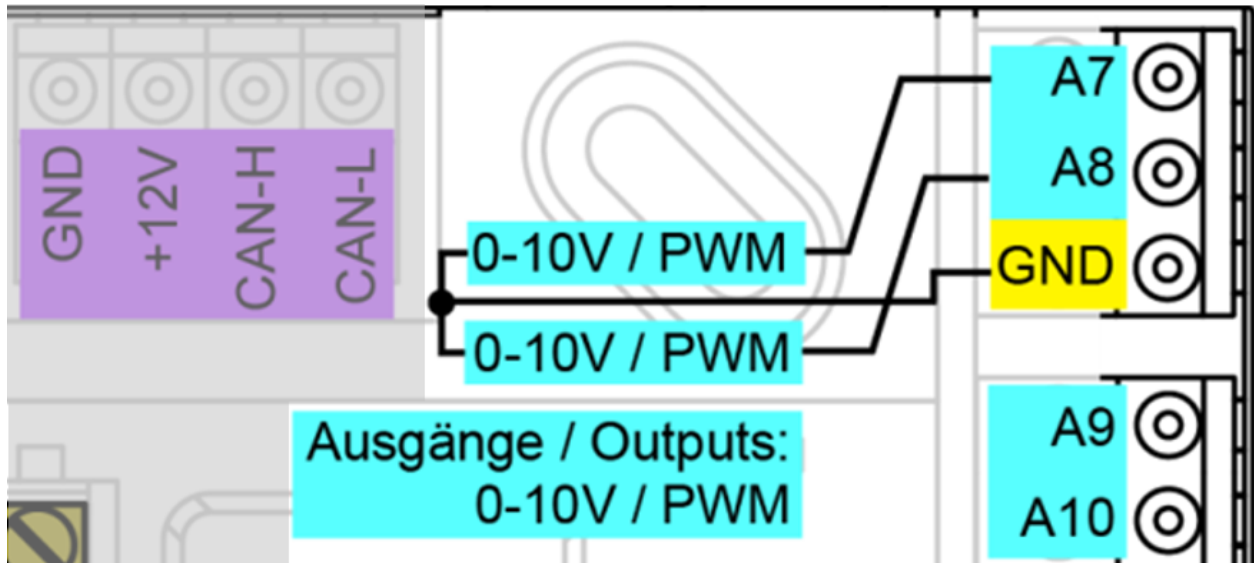

The connections A7-A10 are the positive pole; the GND connection is the negative pole.

When programmed as the "switching output", up to 2 HIREL-230V or HIREL-PF auxiliary relays can be connected.

Connection auxiliary relay HIREL-230V

Example: Connection HIREL16x2 for analogue outputs A7 and A8.

Program outputs A7 and A8 as switching outputs.

The auxiliary relay cannot be integrated in the module; it requires its own enclosure.

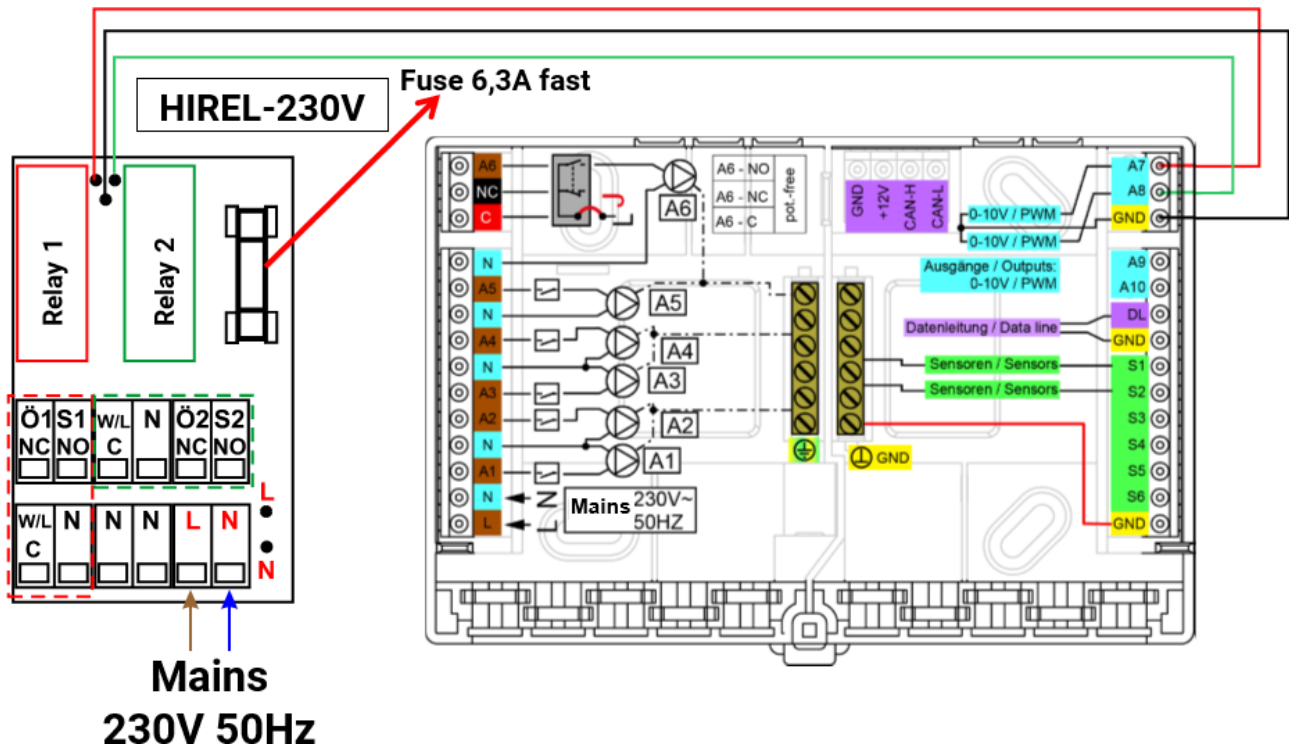

HIREL-230V wiring diagram

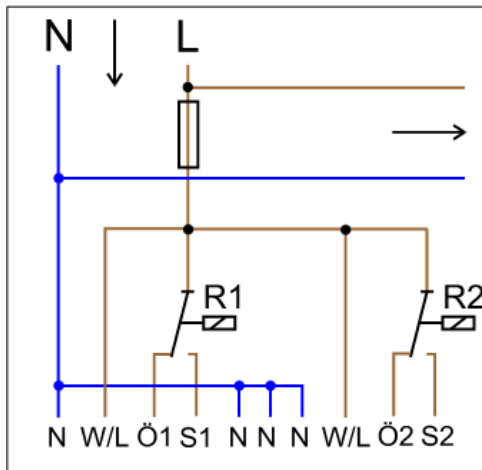

- Relay 1:**
 Ö1... Normally closed contact (N/C)
 S1... Normally open contact (N/O)
 W/L... Root C
- Relay 2:**
 Ö2... Normally closed contact (N/C)
 S2... Normally open contact (N/O)
 W/L... Root C

Both relay outputs are protected by the fuse on the relay module. Terminal "W" therefore corresponds to phase conductor "L".

If the fuse is removed, both outputs will be potential-free whilst remaining connected to one another via root "W".

The relay module can be connected to any two outputs between A7 and A10 if these have been programmed as switching outputs.

Technical data RSM610

All inputs	Temperature sensors of type PT1000, KTY (2 k Ω /25 °C), KTY (1 k Ω /25 °C), PT100, PT500, Ni1000, Ni1000TK5000 and room sensors RAS or RASPT, radiation sensor GBS01, thermocouple THEL, humidity sensor RFS, rain sensor RES01, pulses max. 10 Hz (e.g. for flow rate transducer VSG), voltage up to 3.3 V DC , resistance (1-100 k Ω), and as a digital input
Inputs 4, 5	Auxiliary voltage (0-10 V DC)
Input 6	Also pulse input up to 20 Hz , for flow rate transducer VSG or S0 signals, for example
Outputs 1 - 5	Relay outputs, partially with N/O contacts
Output 6	Relay changeover contact – potential-free
Outputs 7 - 10	Analogue outputs 0-10 V (max. 20 mA) or PWM (10 V/1 kHz), or expansion option as switching outputs with auxiliary relay modules
Output 7 RSM610-A24, -MB24	Supply for external 24 V devices, max. 6 W in total along with the 12 V devices
Output 9 RSM610-MB, -MB24	M-Bus input for up to 4 M-Bus meters
Max. breaking capacity	Relay outputs 230V / 3A each
Max. bus load (DL bus)	100%
CAN bus	Standard data rate 50 kbit/s, adjustable from 5 to 500 kbit/s
M-Bus RSM610-MB, -MB24	Standard baud rate 2400 Bd; adjustable from 300 to 38,400 Bd; data from max. 4 M-Bus devices can be read
12V	Power supply for external devices, max. 6 W in total
Differential temperatures	With separate start and stop differential
Threshold values	With separate start and stop differential or fixed hysteresis
Temperature measuring range	PT100, PT500, PT1000: -200 °C to +850 °C with a resolution of 0.1 K All other temperature sensors: -49.9 °C to +249.9 °C with a resolution of 0.1 K
Temperature accuracy	Typ. 0.4 K, max. \pm 1 K within a range of 0 - 100 °C for PT1000 sensors
Resistance accuracy	max. 1,6% at 100k Ω (measured variable: Resistance, process variable: Resistance)
Voltage accuracy	Typ.1 %, max. 5 % of maximum input measuring range
Output 0-10V accuracy	Max. -2% to +6%
Connection	100 - 230 V, 50 - 60 Hz, (outputs A1 – A5 and device are fused jointly with 6.3 A (fast))
Supply cable	3 x 1 mm ² H05VV-F to EN 60730-1 (cable with standard plug included in the standard sensor pack)
Power consumption	1.0 – 1.9 W, subject to the number of active switching outputs
IP rating	IP40
Protection class	II – double insulated <input type="checkbox"/>
Permissible ambient temperature	+5 to +45°C

Subject to technical modifications.

© 2020

Tips on troubleshooting

Technical support

We offer our customers free support in the event of questions or issues with **our products**.

Important: in order to answer your questions, we require the device serial number **in every case**.

If you are unable to locate the serial number, help with finding it is available on our homepage: <https://www.ta.co.at/en/faq/serial-numbers/>

You can submit your request on our homepage using the following link: <https://www.ta.co.at/en/support-request/>.

As an alternative to the contact form, you can also call us during office hours on the following number: +43 (0)2862 53635

However, before contacting our support services, please try the following solutions:

No display points to a power failure. Therefore, initially check the fuse (6.3 A, (fast)) that protects the device and the outputs (pumps, valves, etc.) from short circuits and from voltage surges in connection with the integrated surge protection. The **glass tube fuse** is located on the back of the module.

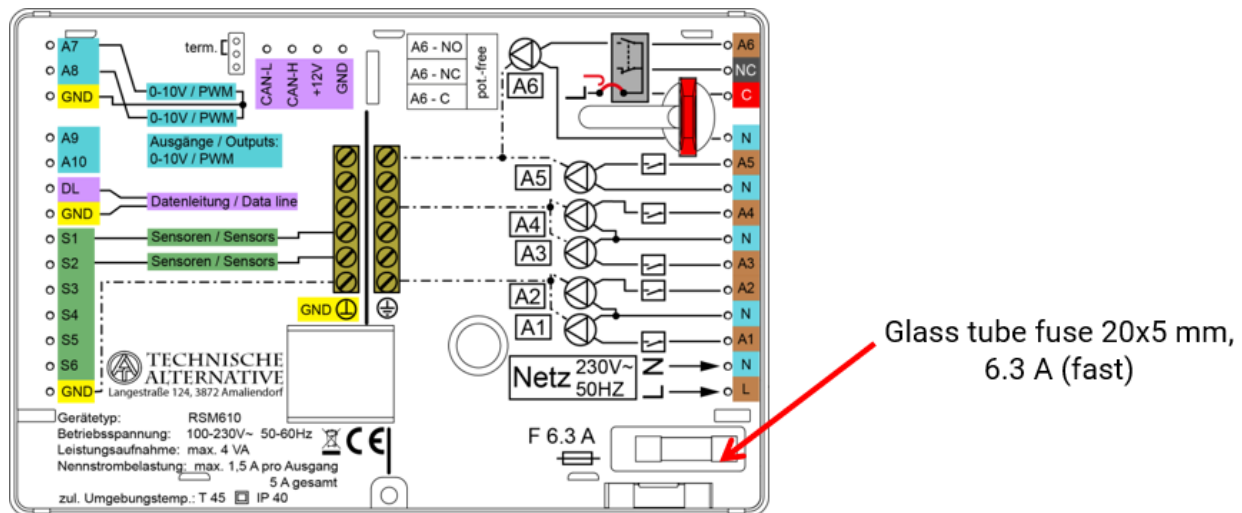

Realistic temperatures but faulty operation of the outputs indicates incorrect settings or termination. The device is in good order if it is possible to switch the outputs ON and OFF in manual mode; check all settings and termination.

- Do constant running and idle periods at the output result in a corresponding response? In other words, does this pump really run if the solar pump is activated manually, or does the heating circuit pump start instead of the solar pump?
- Are all of the sensors connected at the appropriate terminals (heat up the sensor using a lighter and check the temperature display)?

If you still cannot find any faults in the system, we recommend installing a datalogger (C.M.I. or D-LOGG) and recording the temperature curves and switching states. If the DL BUS is used for data logging, enable "data output" in "DL settings".

Incorrect temperatures could be the result of the following:

- Values such as -9999.9 in the case of a sensor short circuit or 9999.9 in the case of a sensor lead break may not be the result of a material or termination error. Is the correct sensor type selected in the input menu (KTY, PT1000, RAS, GBS, etc.)?
- A sensor can also be checked without a tester simply by swapping the sensor that is probably faulty with one that works at the terminal strip and checking the temperature display. If the error is reproduced, the problem is the sensor. However, if the problem remains on the same input of the device, the fault is either due to the sensor type setting or the input itself is faulty (such as faulty surge protection).

Table of resistances of various sensor types

Temp.		0	10	20	25	30	40	50	60	70	80	90	100
PT1000	[Ω]	1000	1039	1078	1097	1117	1115	1194	1232	1271	1309	1347	1385
KTY (2kΩ)	[Ω]	1630	1772	1922	2000	2080	2245	2417	2597	2785	2980	3182	3392
KTY (1kΩ)	[Ω]	815	886	961	1000	1040	1122	1209	1299	1392	1490	1591	1696
PT100	[Ω]	100	104	108	110	112	116	119	123	127	131	135	139
PT500	[Ω]	500	520	539	549	558	578	597	616	635	654	674	693
Ni1000	[Ω]	1000	1056	1112	1141	1171	1230	1291	1353	1417	1483	1549	1618
Ni1000 TK5000	[Ω]	1000	1045	1091	1114	1138	1186	1235	1285	1337	1390	1444	1500

If the sensor is faulty, note the sensor type when replacing. While it is possible to use a different type of sensor, the parameters for that input also have to be set to suit the type of sensor used.

The current standard type used by Technische Alternative is PT1000.

KTY (2 kΩ) was the standard type until 2010/2011.

Manual switching of an output not possible:

- Ensure that **output 6** is generally **potential-free** and therefore does not carry live voltage. Auxiliary relay outputs may also be potential-free. It is thus only possible to directly switch a 230 V consumer when the appropriate wiring has been implemented.
- If it is not possible to switch the output ON or OFF in manual mode, a **message** may be active at that moment which switches the corresponding output **dominantly** ON or OFF (red frame around the output symbol; indication of the message in the upper status bar). Subject to programming and user status, manual mode is not possible in this case.

Troubleshooting – hardware

In a clear case of a hardware fault, please return the device to your retailer or the manufacturer for repair. In this case it is essential to include a fault description with the device (simply stating "the device does not work, please repair" is insufficient). Processing is accelerated if an RMA number is requested via our homepage www.ta.co.at. The defect must be clarified with our technical support beforehand.

Troubleshooting – programming

The manufacturer can assist you in troubleshooting if you have the correct documentation and sufficient data to hand. The following are indispensable for this:

- a hydraulic scheme via fax or email (WMF, JPG),
- the complete program via TAPPS file or at least the function data (*.dat file) by email,
- operating system version and controller serial number,
- all existing log files or at least the (temperature) values of the inputs at the time the system malfunctioned,
- telephone contact for describing the problem – in most cases a written fault description is not enough.

Troubleshooting in the CAN network

To isolate the error we recommend shutting down part of the network and monitoring when the error disappears.

General tests:

- Node numbers – no node number must be assigned twice
- Power supply to BUS subscribers (if necessary use the CAN-NT power supply unit)
- Setting of the Baud rate (even when using the CAN BUS converter CAN-BC2)

Wiring test:

All nodes must be switched off for this test.

- Resistance across CAN-H and CAN-L
 - If this is in excess of 70 Ω , it indicates incorrect termination.
 - If the resistance is below 60 Ω , look for too many terminations or short circuits between cables/leads.
- Check for short circuits across GND or screen and the signal cables.
- Check for earth loops – for this the screen is undone at each node and the current tested. If there is a current flow, an earth loop has been created by an unwanted earth connection.

Information on the ECO-design Directive 2009/125/EC

Product	Class ^{1,2}	Energy efficiency ³	Standby max. [W]	Power consumption typ. [W] ⁴	Max. power consumption [W] ⁴
RSM610 ⁵	max. 8	max. 5	1,0	0,80 / 1,55	1,0 / 1,9

¹Definitions according to Official Journal of the European Union C 207 dated 03/07/2014

² The classification applied is based on optimum utilisation and correct application of the products. The actual applicable class may differ from the classification applied.

³ Contribution of the temperature controller to seasonal central heating efficiency in percent, rounded to one decimal place

⁴ No output active = standby / all outputs and display active

⁵ The class is defined on the basis of the programming of the heating circuit controller, in accordance with the Ecodesign Directive.

EU Declaration of conformity

Document- No. / Date: TA17023 / 02.02.2017
Company / Manufacturer: Technische Alternative RT GmbH
Address: A-3872 Amaliendorf, Langestraße 124

This declaration of conformity is issued under the sole responsibility of the manufacturer.

Product name: RSM610, RSM610-24, RSM610-MB, RSM610-MB24
Product brand: Technische Alternative RT GmbH
Product description: Control module

The object of the declaration described above is in conformity with Directives:

2014/35/EU Low voltage standard
2014/30/EU Electromagnetic compatibility
2011/65/EU RoHS Restriction of the use of certain hazardous substances
2009/125/EU Eco-design directive

Employed standards:

EN 60730-1: 2011	Automatic electrical controls for household and similar use – Part 1: General requirements
EN 61000-6-3: 2007 + A1: 2011 + AC2012	Electromagnetic compatibility (EMC) - Part 6-3: Generic standards - Emission standard for residential, commercial and light-industrial environments
EN 61000-6-2: 2005 + AC2005	Electromagnetic compatibility (EMC) - Part 6-2: Generic standards - Immunity for industrial environments
EN 50581: 2012	Technical documentation for the assessment of electrical and electronic products with respect to the restriction of hazardous substances

Position of CE - label: On packaging, manual and type label



Issuer: Technische Alternative RT GmbH
A-3872 Amaliendorf, Langestraße 124

This declaration is submitted by

A handwritten signature in black ink that reads 'Schneider Andreas'. The signature is written in a cursive, flowing style.

Dipl.-Ing. Andreas Schneider, General manager,
02.02.2017

This declaration certifies the agreement with the named standards, contains however no warranty of characteristics.

The security advices of included product documents are to be considered.

User manual

This brief guide is aimed at the final user of the module.

For information about programming or installing the controller, separate instruction manuals are available on our homepage (www.ta.co.at) and on the controller's SD card.

The RSM610 control module can be used as a separate controller or as an add-on module for the freely programmable UVR16x2 controller. Unlike the UVR16x2, however, the module does not have an operating display screen directly on the device. Consequently, it is operated from either the UVR16x2 (version V1.13 or higher), the CAN-MTx2 CAN monitor or the C.M.I.

The wide variety of systems means that a single instruction manual for all application scenarios is not possible. You should therefore always seek instructions from your heating system installer.

When the module is used **in conjunction with UVR16x2 or CAN-MTx2**, the programmer will create a **"function overview"** in the controller for user operation. This function overview may also include the RSM610. In the function overview, you can check all important measurements and change settings in selected functions which are important to you as the user.

The RSM610 can also be operated via the **C.M.I.** Control and Monitoring Interface. In that case, the **"online scheme"** is provided for operation by the user. Operation via the online scheme is essentially the same as when using the function overview.

In this manual, we explain how you can select the function overview or online scheme and how you can adjust the settings on your system.

Note: Your personal system will normally vary from the examples in this manual.

LED status indicators

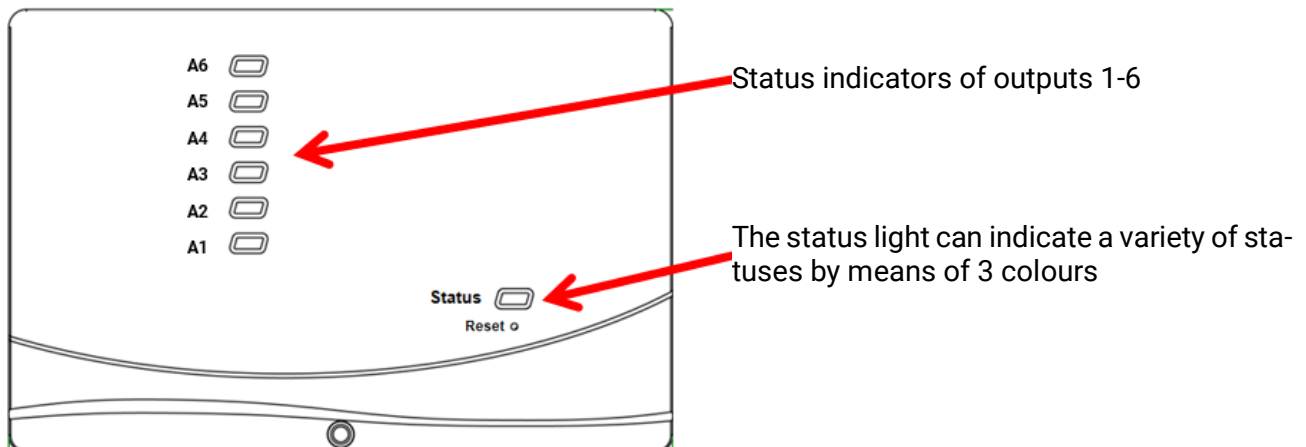

An active **Message** can be displayed by a change in a status indicator. This can be set in the **Parameters menu** of the **"Message"** function.

Status indicators at controller start

Indicator light	Explanation
Steady red light	The controller is booting up (= start routine after switching on, resetting or updating) or
Steady orange light	Hardware is initialising after booting up
Flashing green light	After hardware initialisation, the controller waits about 30 seconds to receive all the information necessary for a function (sensor values, network inputs)
Steady green light	Normal operation of the controller

Operation via UVR16x2 or CAN-MTx2

User levels

To prevent incorrect operation of the controller, three different user groups can log onto the controller: **User**, **Technician** or **Expert**. Access by Technicians and Experts requires a password.

The controller is always in User mode when the controller is started or when new function data has been loaded.

User level	Displays and permitted actions
User	<ul style="list-style-type: none"> • Function overview with options for control • Access to main menu only if enabled for "User" in the "General settings" • Summary of values • Inputs: display only, no access to the parameters • Outputs: changes to the output status of the outputs enabled for User, display of hours run, no access to the parameters • Fixed values: changes to the value or status of the fixed values enabled for User, no access to the parameters • Functions: display of the function status, no access to the parameters • Messages: display of active messages, hiding and deleting messages • CAN and DL bus: no access to the parameters • General settings: No access • User: change of user (with password entry), setting of left/right-handed • System values: setting the date, time, location data, display of System values
Technician	<p>All of the above plus:</p> <ul style="list-style-type: none"> • Access to main menu only if enabled for Technician or User in the "General settings" • Changes to the parameters for inputs (except for type and measured variable), no creation of new ones • Changes to the parameters for outputs (except for type; status only if enabled for User or Technician), no creation of new ones • Changes to the parameters for fixed values (except for type and measured variable; value and status only if enabled for User or Technician), no creation of new ones • General settings: Changes to user defined designations and creation of new ones, selecting the currency • Functions: changes to user defined input variables and parameters; output variables are visible • All settings in the • CAN and DL bus menus • Data administration actions
Expert	All actions and all displays are accessible.

The devices are operated via a 4.3" **touch-screen**. For greater ease of use, an **operating pen** is provided.

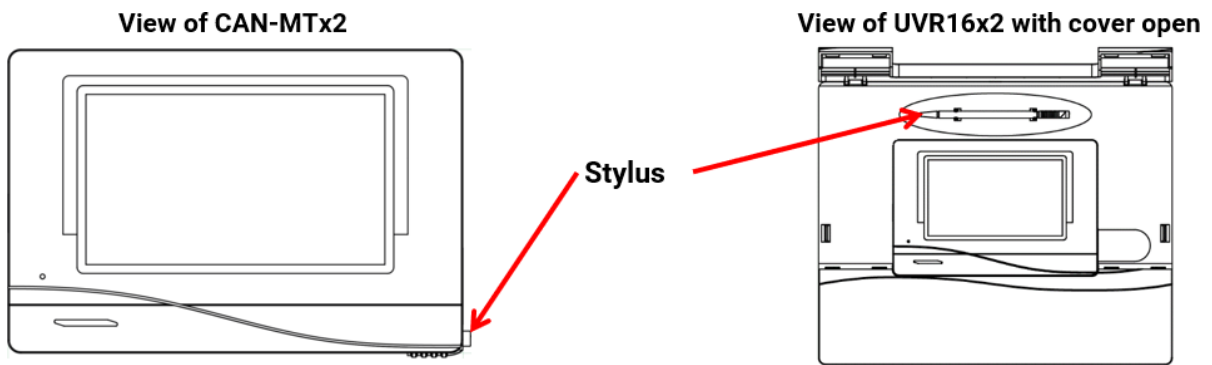

You can use the pen to tap operating fields on the screen and can scroll the view displayed by sliding it with the pen.

Information displayed on the controller

After the controller has been booted up (= started), the display either shows the function overview (if loaded) or the main menu of the controller.

If only **technicians** or **experts** are permitted to access the menu, then the relevant **password** must be entered.

When the controller is **restarted**, either the **function overview** (if loaded) or, in the case of restricted access, the **keyboard** for the password is displayed.



Main menu display



In the main menu you can view settings and display values in various sub-menus and can also change certain statuses that have been enabled for you.

Tap the "Home icon"  to go to the **Function overview**. The function overview is the most important menu for the user. There you can enter your settings and check sensor values.

If you tap the icon , you can view all the devices connected to the controller via the **CAN bus** and can access the menus of any devices with **x2 technology**.

Function overview display

The function overview can be programmed as standard view or full screen view.

Standard view

Examples:

Starting page with 4 links

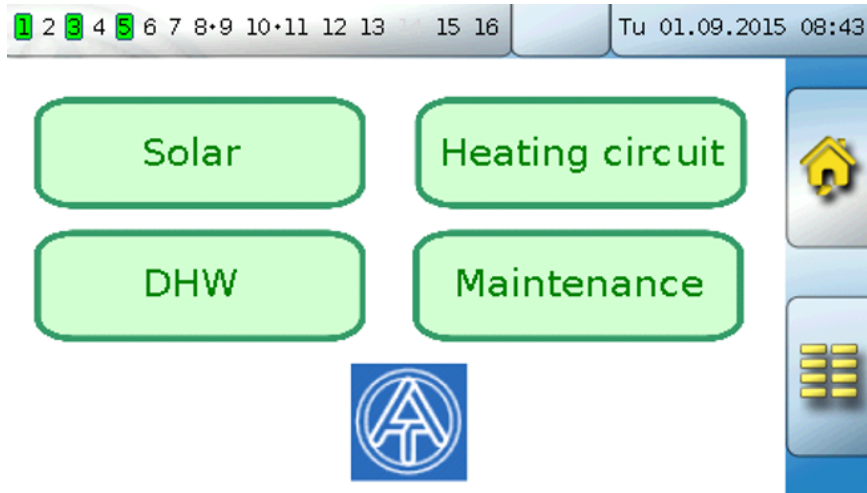

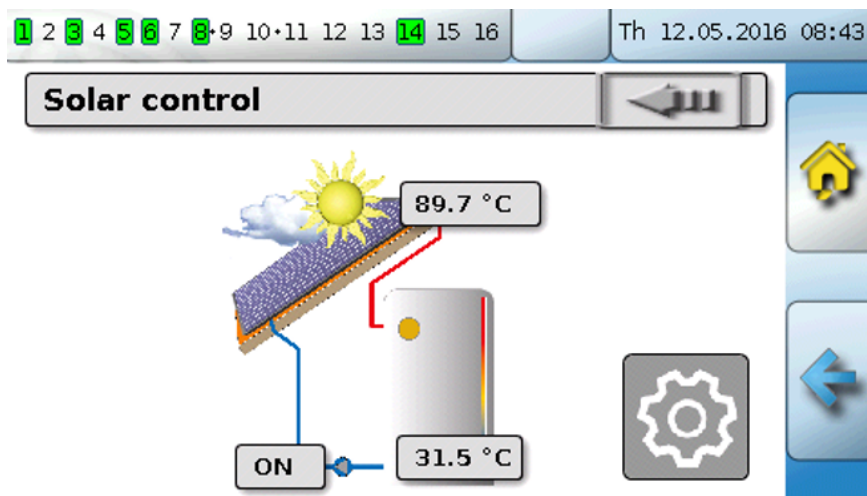

From the **start page** (= first page), tapping  takes you to the controller's **main menu**. If only **technicians** or **experts** are permitted to access the menu, then the relevant **password** must be entered.

Page with graphic display solution and links for accessing other pages:



You can go back to the page **displayed previously** by tapping  .

To go to the **start page** of the function overview, tap  .

From the **start page**, tapping  takes you to the controller's **main menu**. If only **technicians** or **experts** are permitted to access the menu, then the relevant **password** must be entered.

If you press the background image for 3 seconds, 2 buttons appear which serve to access the version information and the general settings respectively.

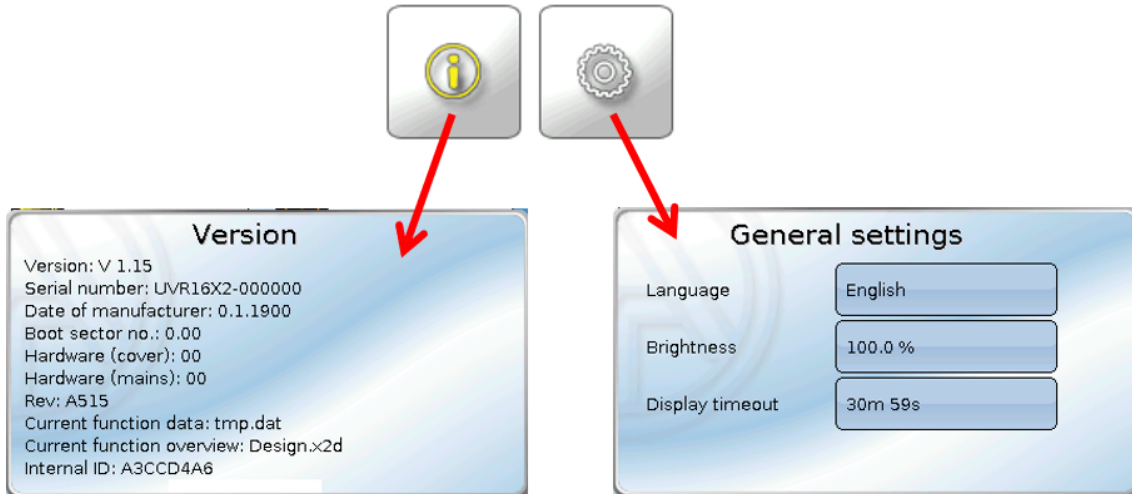

You can go back to the page **displayed previously** by tapping  .

Full screen view

In the full screen view, the upper status bar and the side buttons are hidden.

Examples:

Start page with 4 links



Page with graphic elements and links to time switch, calendar and settings:

Heating circuit		
Operating mode	Standard (1)	
Room temperature	20.5 °C	
Outside temperature	-0.4 °C	
Effective set room temp.	20.0 °C	
Flow temperature	43.8 °C	
Set flow temperature	43.5 °C	
Htg circ. pump	ON	

If you press the background image for 3 seconds, 4 buttons appear which enable access to the version information of the controller, the general settings or the date, time and location settings, and the main menu of the controller.

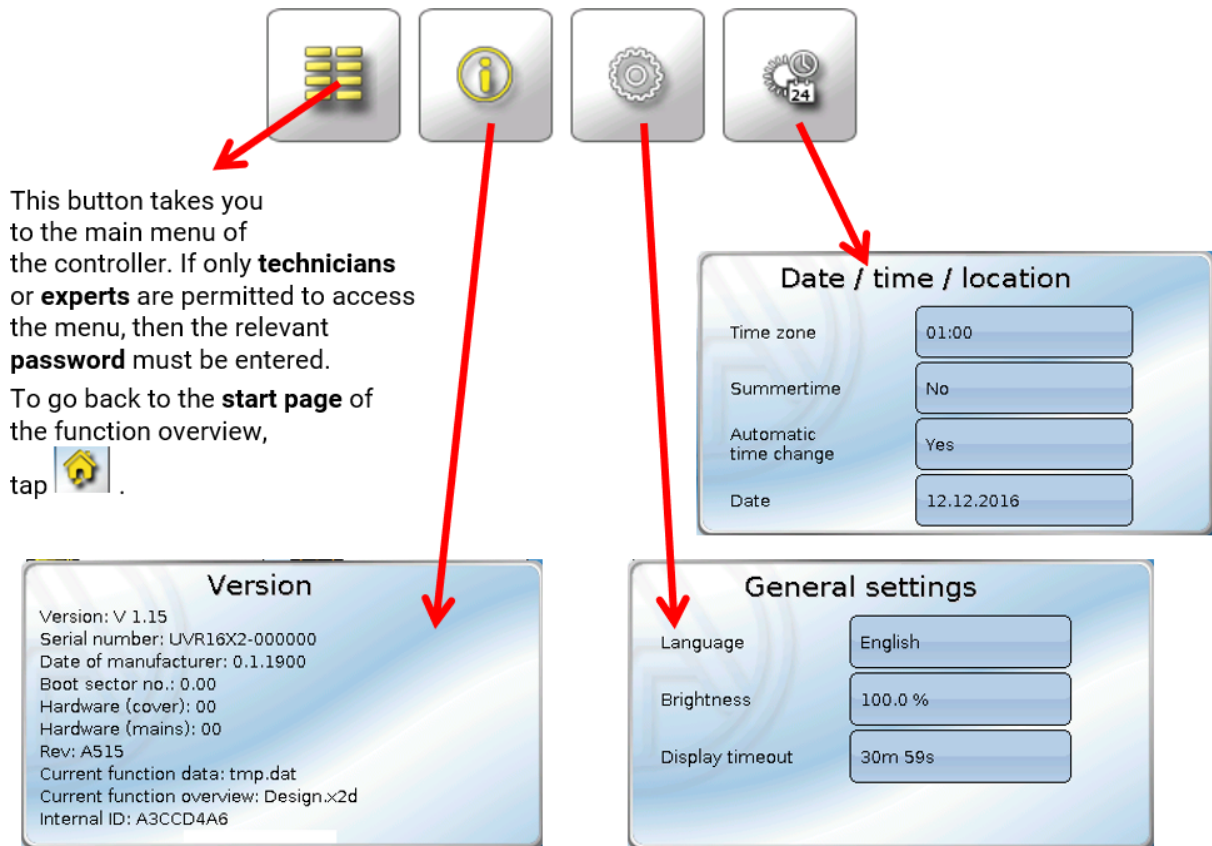

This button takes you to the main menu of the controller. If only **technicians** or **experts** are permitted to access the menu, then the relevant **password** must be entered. To go back to the **start page** of the function overview, tap  .

Version
Version: V 1.15
Serial number: UVR16X2-000000
Date of manufacturer: 0.1.1900
Boot sector no.: 0.00
Hardware (cover): 00
Hardware (mains): 00
Rev: A515
Current function data: tmp.dat
Current function overview: Design.x2d
Internal ID: A3CCD4A6

General settings
Language: English
Brightness: 100.0 %
Display timeout: 30m 59s

Date / time / location
Time zone: 01:00
Summertime: No
Automatic time change: Yes
Date: 12.12.2016

You can go back to the page **displayed previously** by tapping  .

Status line

The top part of the display shows the output status, messages, faults, date and time.

Output status

Active outputs are highlighted against a **green** background.

In the following example, outputs 1, 3 and 6 are active.



Output 5 has been **deactivated** manually (Manual/OFF) and output 6 has been **activated** manually (Manual/ON). Outputs that have been switched to Manual/OFF or Manual/ON are marked with a **hand symbol** under the output number.

When a message is active, outputs may be switched to dominant off or dominant on. This is indicated by a red border around the affected output.

Output pairs (e.g. for mixer drive) are shown in the status line with a **+** between the output numbers.

Example: Outputs **8+9** and **10+11** have been programmed as output pairs



Tapping the outputs display takes you to the **Outputs** menu.

System values (date, time, location)

The system values **Date** and **Time** are shown in the status line at top right.

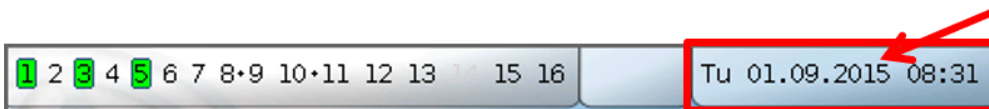

Tapping that status field takes you to the menu for the system values.

Example:



The system value parameters **that you can change** are displayed first.

- **Time zone - UTC** stands for "Universal Time Coordinated", also known as GMT (= Greenwich Mean Time).
- **Summertime - Yes** if summertime is active.
- **Automatic time change** – If **Yes**, the time will switch over automatically to summertime according to the specifications of the European Union.
- **Date** – The current date (DD.MM.YY).
- **Time** – The current time
- **GPS latitude** – Geographical latitude according to GPS (= global positioning system)
- **GPS longitude** – Geographical longitude according to GPS

The values for geographical latitude and longitude are used to determine the location-specific solar data. That data can be used in functions (e.g. shading function).

The factory default settings for the GPS data are for the location of Technische Alternative in Ama-liendorf, Austria.

Next, the location-specific **solar data** is displayed.

Example:

Sunrise	06:15
Sunset	19:44
Solar altitude	30.8 °
Direction of the sun	114.9 °

- **Sunrise** - Time
- **Sunset** - Time
- **Solar altitude** – Specified in ° as measured from the geometric horizon (0°), zenith = 90°
- **Direction of the sun** – Specified in ° as measured from the north (0°)
North = 0°
East = 90°
South = 180°
West = 270°

Messages, faults

The centre part of the status line displays messages and faults by means of warning symbols.

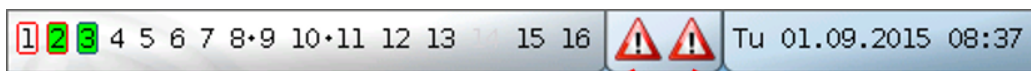

Left: indicates one or more messages

Right: indicates one or more sensor or bus errors

Tapping the warning symbol on the **left** opens the pop-up window for a "hidden" message. Tapping the warning symbol on the right takes you to the "Messages" menu.

Function overview

If you are in the main menu, tapping the "Home" button  opens the function overview.

The function overview can be **freely designed** by the programmer and can therefore look different on every controller. It can be displayed with the aid of **graphics** or simply as a **table**.

Values selected by the programmer can be changed either by all users, by Experts only or by Experts and Technicians. Many values (e.g. sensor values) can generally never be changed.

If multiple UVR16x2 controllers or other X2 devices in the system are linked by CAN bus, the function overview can also be programmed to display the values of other devices.

The function overview can comprise several pages, in which case a **Link** (= link on the screen linking to another page) is required for switching to a different page. The appearance of links can be freely designed by the programmer. Access to some pages may be restricted to certain user groups (with or without password entry).

The function overview can be programmed with the first page showing an overview of the following pages with links to those pages.

Touching the relevant link takes you to the display on the required page.

Changing values

Tapping the required value opens either a keypad or a selection box. Values can only be changed if they have been enabled for the user level by the programmer.

Example:

Changing the set room temperature "T.room standard" via a keypad:

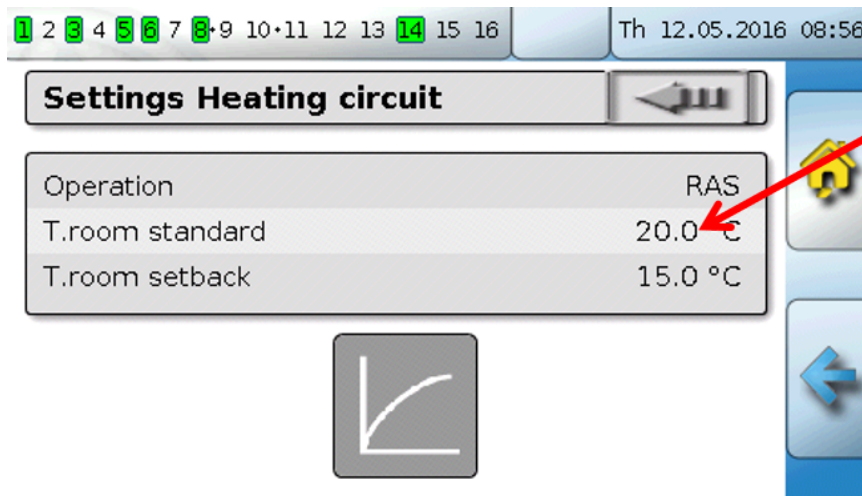

The **keypad** then appears:

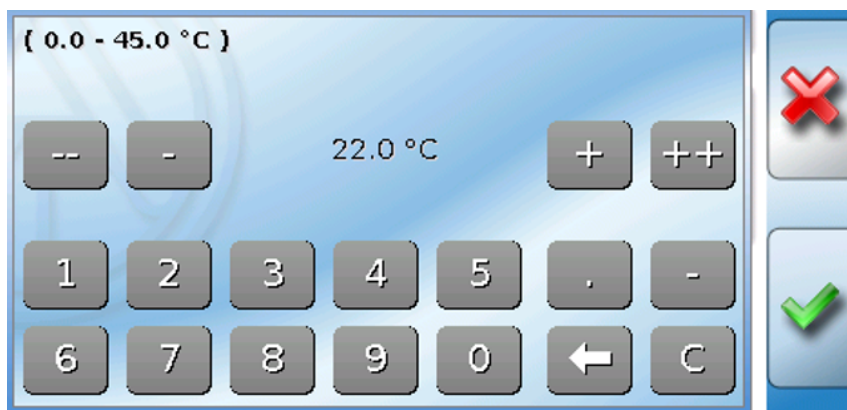

The current value is shown (example: 20.0 °C).

The top line shows the permitted entry range (example: 0.0 – 45.0 °C).

You can make entries using either the correction keys (--, -, +, ++) or the numeric keys. The correction keys - and + change the value of the first digit to the left of the decimal point (units); keys -- and ++ change the value of the second digit (tens).

The arrow key ← shortens the value by one digit place; key C sets the value to zero.

Finish your entry with ✓, discard it with ✗.

Example:

Changing the operating mode of the heating circuit with a **selection box** ("RAS" means that the operating mode is set by the room sensor's slide switch):

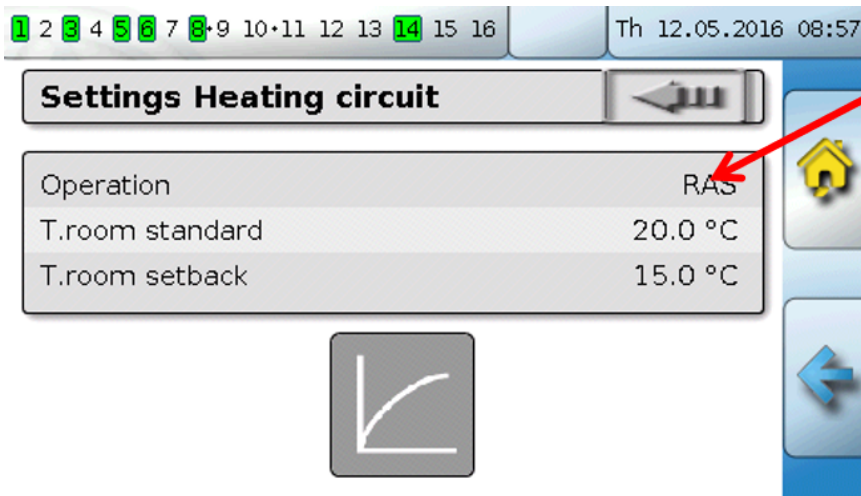

A selection box appears with all possible settings:

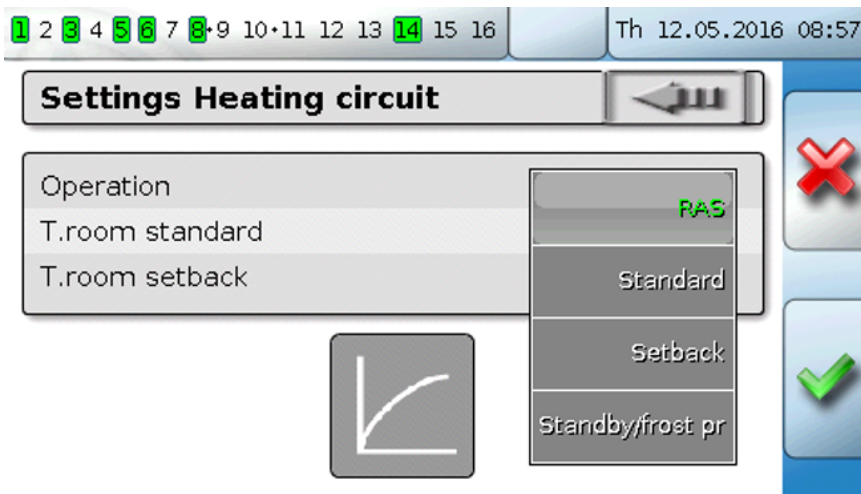

When you tap the required setting, it is changed and the required setting is displayed in the function overview.

Some functions have a **touch field** e.g. for starting DHW demand outside the demand time.

Example:

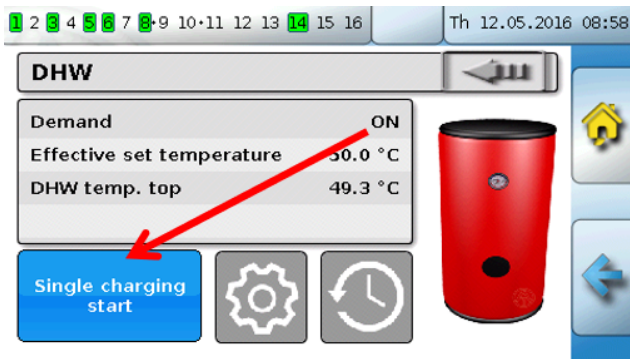

Tapping the **field** starts the action.

The most important functions

The most important functions for the user are:

- Heating circuit
- Time switch
- Calendar
- Individual room control
- DHW demand
- Solar control

Various setting parameters for these functions are described in the following:

Heating circuit

In the heating circuit function, the **set flow temperature** is determined for the heating circuit and the heating circuit pump is switched off or on according to adjustable shutdown conditions.

In many systems, the set flow temperature is calculated according to the outside temperature, the setting parameters, the time program and, if a room sensor is installed, the room temperature, and is then defaulted as the set temperature for a mixer or a boiler.

Consequently, the following pages may be visible on the function overview.

Page with **display values** which cannot be changed:

Heating circuit	
Operating mode	Standard (1)
Room temperature	20.5 °C
Outside temperature	-0.4 °C
Effective set room temp.	20.0 °C
Flow temperature	43.8 °C
Set flow temperature	43.5 °C
Htg circ. pump	ON

Control icons and links:

- Time switch icon: "Time switch" link
- Calendar icon: "Calendar" link
- Settings icon: "Settings" link

Operating mode shows the currently active operating mode. The operating mode is set by the controller setting for "Operation", the calendar function, the maintenance function, the "Window contact" status or the "External switch" status. Depending on the status of these functions and input variables, the operating mode may therefore vary from the internal setting for "Operation".

The Room temperature and the Flow temperature are the current **measurements**.

The Effective set room temperature and the Set flow temperature are the current **set values**.

When the heating circuit pump is switched off due to a shutdown condition or the heating circuit is in standby mode, the set flow temperature is shown as 5 °C.

If the outside temperature sensor is faulty or the sensor lead is disconnected, the heating circuit switches to **Fault** mode. In that case, the heating circuit is controlled to a fixed outside temperature of 0 °C. The fault on the outside temperature sensor is displayed in the upper status line if "Sensor check" is activated.

1 2 3 4 5 6 7 8 9 10 11 12 13 15 16  We 09.09.2015 14:59

Heating circuit	
Operating mode	Fault (9)
Room temperature	20.3 °C
Outside temperature	9999.9 °C

Control icons and home button:

- Time switch icon
- Calendar icon
- Home button

Settings for the **heating circuit operation** with an additional **link to the heat curve parameters**:

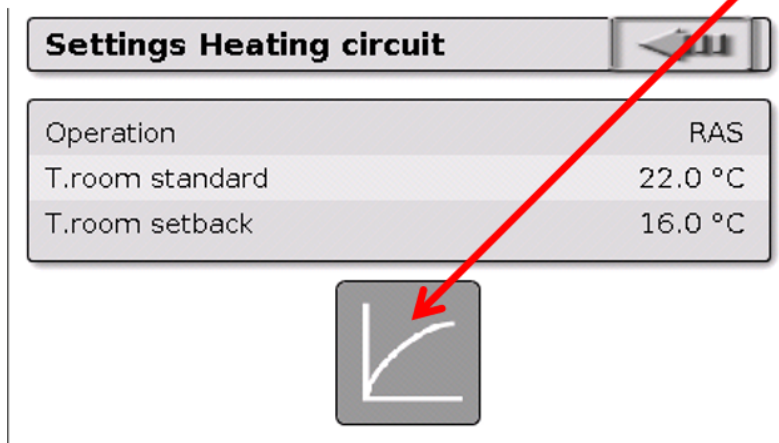

You can change the **internal** operating mode of the function by changing the **Operation** setting. **RAS** indicates that the setting of the room sensor is applied. If there is no room sensor installed, the setting **Time/auto** applies the time switch's time program to the heating circuit. Other options to choose from are **Standard** (= continuous heating mode), **Setback** (= continuous setback mode) or **Standby/frost protection** (= heating circuit shutdown subject to the programmed frost protection conditions).

In **Standby** mode, the controller's **frost protection function** is operational. The programmer defines the **frost protection limits** for the outside temperature and (if a room sensor is installed) the room temperature. If one of those temperatures falls below the limit, frost protection is activated and the heating circuit pump is switched on. The set flow temperature will be set to at least the programmed minimum temperature. The activation of frost protection can be delayed when changing over from standard to setback mode.

The **internal** operating mode may differ from the actual operating mode because the calendar function, the maintenance function, window contacts and the "External switch" can override the internal operating mode.

T.room setback is the required room temperature in **setback mode** if a room sensor is installed. If there is no room sensor, this value represents a notional room temperature. Changing this value moves the heat curve upwards or downwards to a **parallel** position, thus increasing or decreasing the calculated set flow temperature.

T.room standard is the corresponding value for **heating mode**.

The changeover between heating mode and setback mode is carried out with the **Time switch** function, which is described in the next chapter.

Settings for the heat curve:

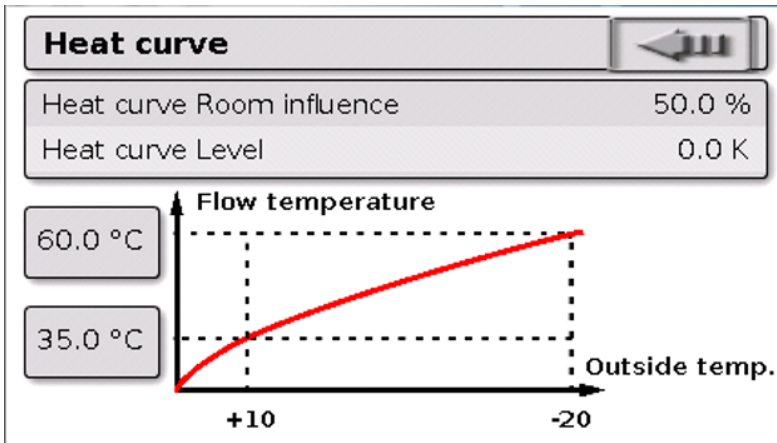

Room influence: If a room sensor is installed, you can use this setting to define how much influence the actual room temperature should have on the calculation of the set flow temperature. Values higher than 50 % will have a very great influence and will be unfavourable in most cases.

Level: This parameter influences the calculation in the same way as changing the values T.room standard and T.room setback, but affects both heating mode and setback mode. It too moves the heat curve to a parallel position. Negative values can be entered as well.

The heat curve can be defined using two different methods:

Definition of the set flow temperature by **two outside temperature points at +10 °C and -20 °C**, or by the **slope**.

In the example above, the method with the two temperature points was chosen. With **T.flow +10 °C** and **T.flow -20 °C**, both the slope and the curvature of the heat curve can be defined, allowing the heat curve to be optimally matched to the system.

If the "slope" method is chosen, the slope can be defined instead of the two temperature points.

Time switch

The **Time switch** function is used to define the changeover between T.room standard and T.room setback in the **heating circuit**. The function can be programmed for a single heating circuit only, or jointly for several heating circuits. The "Time switch" can also be used to switch other functions or statuses.

There are up to **7 time programs** available with up to **5 time windows** available per time switch. It is also possible to subject the start and OFF times to the influence of other variables, and to specify your own set values for the time window.

The following describes the simple setting of a time program without set values:



In **Time program 1** the days **Monday – Friday** have been selected (the red keys). The first time window goes from **06:00 to 09:00 h**, the second one from **16:00 to 22:00 h**, and the third time window is unused.

Tapping **2** allows you to switch to the 2nd time program, for the weekend:

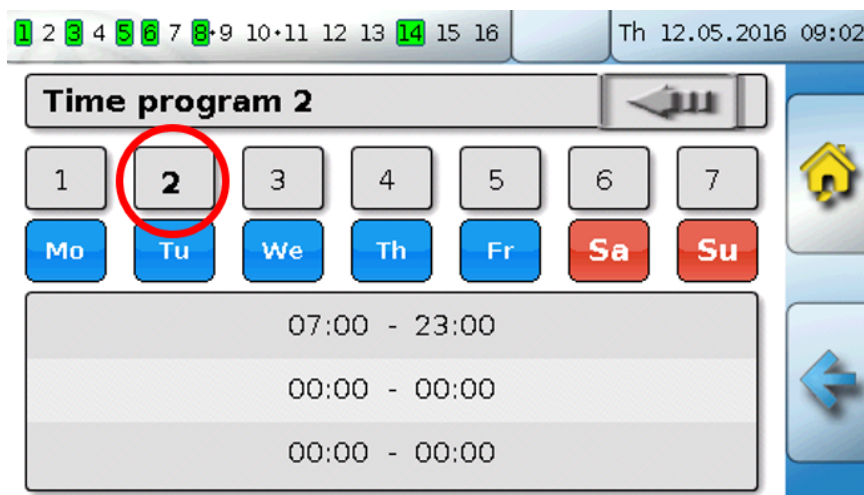

For the **weekend**, only the first time window from **07:00 to 23:00 h** has been set.

Calendar

The calendar function overwrites the internal settings and specifications of the time switch for the heating circuit. The following calendar modes can be set:

- **Holiday**
- **Party**
- **Bank holiday**
- **Standby**

There are up to 10 date windows available in which each mode can be set. Up to 3 set values can be set in each mode, one of which can be applied in the heating circuit as the set room temperature.

The respective appearance in the function overview can vary greatly. The following describes one possibility:

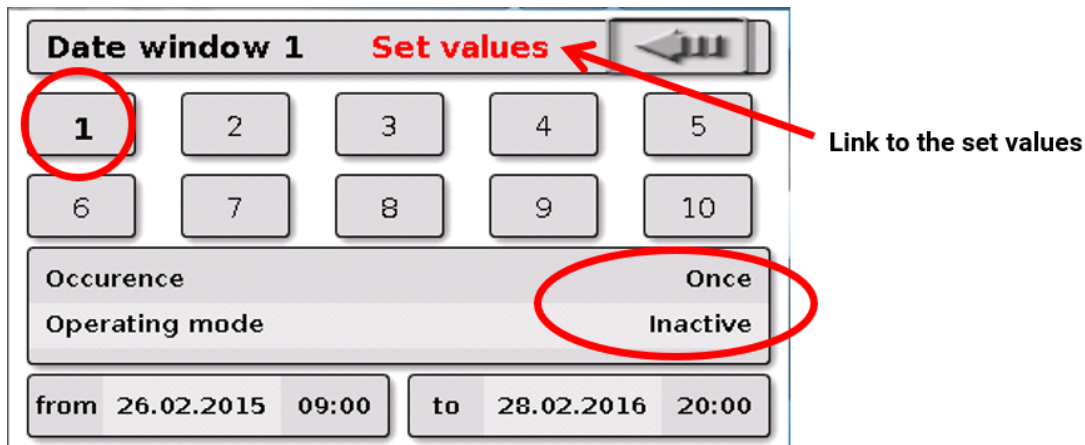

The calendar function is currently **Inactive**. Here you can define whether the calendar mode should be applied once or annually. Tapping the displayed **Operating mode** allows you to set the required operating mode:

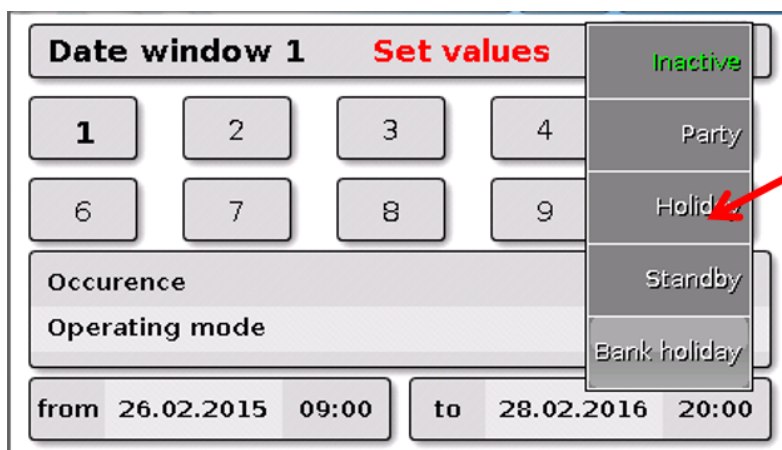

After selecting the operating mode, the **Start** and **End** are selected.

A **Holiday** has been set from 26/02/2015 09:00 h to 28/02/2015 20:00 h. During that time, the programmed set room temperature ("Set value") for holiday will be applied.

The **Holiday (6)** operating mode is visible in the **Heating circuit** menu when the conditions are met:



Individual room control

This function is specially designed for the control of **zone valves** for heating and/or cooling of individual rooms. Room temperature thresholds and the operating mode switch on the room sensor can be utilized to switch between heating and cooling. Shutdown conditions prevent heating or cooling beyond the outside temperature thresholds.

The floor temperature can also be monitored in order to prevent excessive cooling or heating of the floor.

Example:

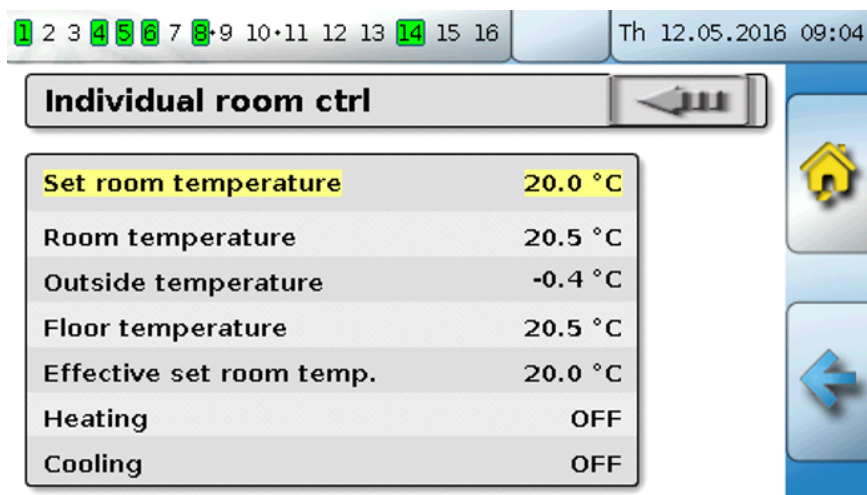

The screenshot shows a control interface for 'Individual room ctrl'. At the top, there is a navigation bar with numbers 1 through 16, where 14 is highlighted. To the right of the navigation bar, the date and time are displayed as 'Th 12.05.2016 09:04'. Below the navigation bar, the title 'Individual room ctrl' is shown with a back arrow icon. The main content area displays a table of settings:

Set room temperature	20.0 °C
Room temperature	20.5 °C
Outside temperature	-0.4 °C
Floor temperature	20.5 °C
Effective set room temp.	20.0 °C
Heating	OFF
Cooling	OFF

On the right side of the interface, there is a vertical sidebar with a home icon and a blue arrow icon pointing left.

The highlighted **Set room temperature** can be an adjustable setting. However, this value can also be a set value defaulted by a time program in a **Time switch** function.

All other values are display values indicating the status of the room.

If both heating and cooling are provided, the operating mode switch of a **RASPT**, **RAS-PLUS** or **RAS-F room sensor** can be used to define the operating mode of the function:

 **AUTO**: The system switches automatically between heating and cooling according to settings.

 **STANDARD**: Only heating mode is allowed.

 **SETBACK**: Only cooling mode is allowed (frost protection remains active).

DHW demand

This function is used in many systems to define the domestic hot water cylinder temperature.

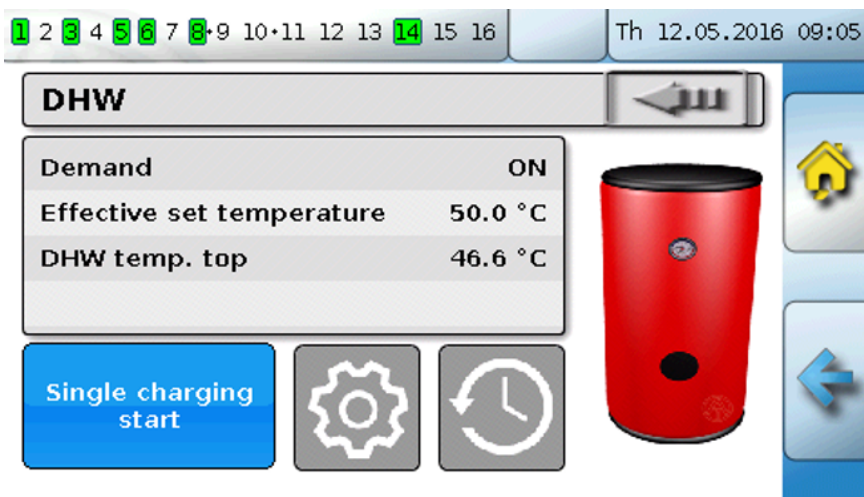

The **Demand** is currently set to **OFF**, so the effective set temperature is only 5 °C.

You can define the set temperatures via the **Settings** key (gearwheel):

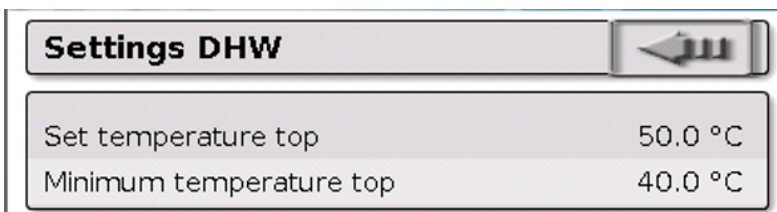

The DHW demand can be switched between two set temperatures via a time program from the **Time switch** function. The **Set temperature** applies inside the time window, and the **Minimum temperature** applies outside it.

The **Single charging start key** can be used to start demand outside the time window. It remains switched on until the set temperature is reached.

The time switch may look similar to the time switch for the heating circuits:

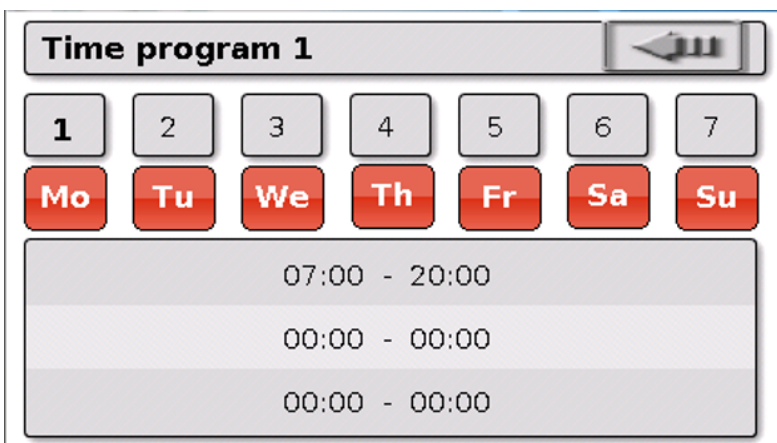

Here, a uniform time of 07:00 – 20:00 h has been selected for the entire week.

Solar control

The solar control starts or stops a **solar pump** based on the differential between the **collector** temperature and a **reference** temperature (e.g. temperature at the bottom of a cylinder). Option: use of a limit sensor (e.g. temperature at the top of the cylinder).

Start conditions for the solar pump:

1. The **collector temperature** must exceed the minimum collector temperature and must not exceed the maximum threshold "T.coll. max.".
2. The set **differential** between the collector temperature and the reference temperature must be exceeded.
3. The **reference temperature** must not yet have reached its maximum limit "T.ref. max.".

If the **optional** limit sensor is used, it must not have reached the **limit temperature**.

Example (without limit sensor) with a link to the settings:

T.coll. max.	130.0 °C
Minimum temp. collector	30.0 °C
T.cylinder, max bottom	70.0 °C

When the collector exceeds a certain temperature (e.g. 130 °C) the system comes to a standstill and it is assumed that steam is present in the collector, usually making circulation of the heat transfer medium impossible. For this reason, the collector sensor has an adjustable maximum limit, **T.coll. max**. If that limit is exceeded, the solar function stops and is not enabled again until the collector temperature drops below a certain level (usually 110 °C). This protective function prevents overheating of the solar pump due to lack of circulation.

The maximum cylinder temperature **T.cylinder, max bottom** should be selected according to whether the cylinder is used as a DHW or as a buffer cylinder.

Messages

Sensor and bus errors

Subject to programming, the "Messages" menu may also display faulty sensors and incorrect CAN and DL inputs. Faults of this kind are indicated by the **right-hand warning symbol** in the status line.

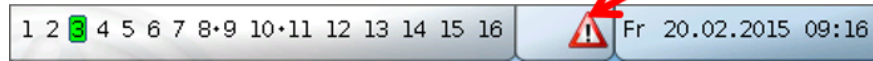

Tapping the warning symbol takes you to the **Messages** menu. The incorrect inputs are displayed there.

Example:

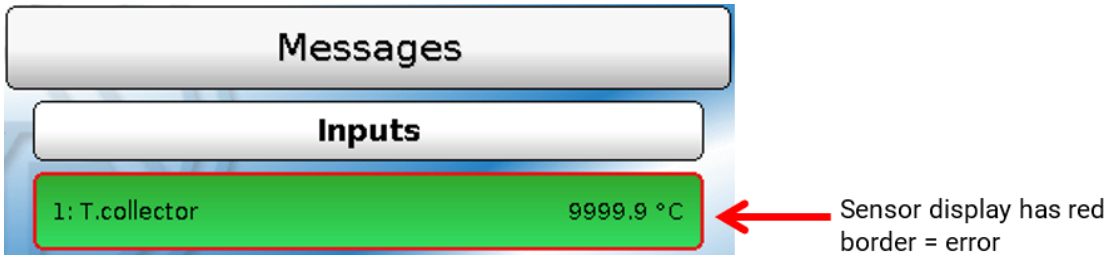

The display of 9999.9 °C for sensor 1 indicates an interruption (sensor faulty or lead break). If -9999.9 °C was displayed, it would mean a short circuit in the sensor or sensor lead.

Deleting a message

The message can be **deleted** in the Parameter menu. The message cannot be deleted until the cause for the message has been removed.

Fault message type only: A specific **Reset fault** output variable is available in order to reset external devices. Activating "Reset fault" (in the Parameter menu) generates an ON pulse lasting three seconds regardless of whether the message cause still exists at that time or not. If the event no longer occurs after the pulse, the message is deleted as well. This pulse can be used elsewhere in programming as well and therefore has various effects.

Operation via C.M.I.

The C.M.I. can be accessed either via a PC / network, via the Internet and the C.M.I. web portal (<https://cmi.ta.co.at>) or by port forwarding on the router.

When you log in with an access code, the **home** page of the C.M.I. will appear.

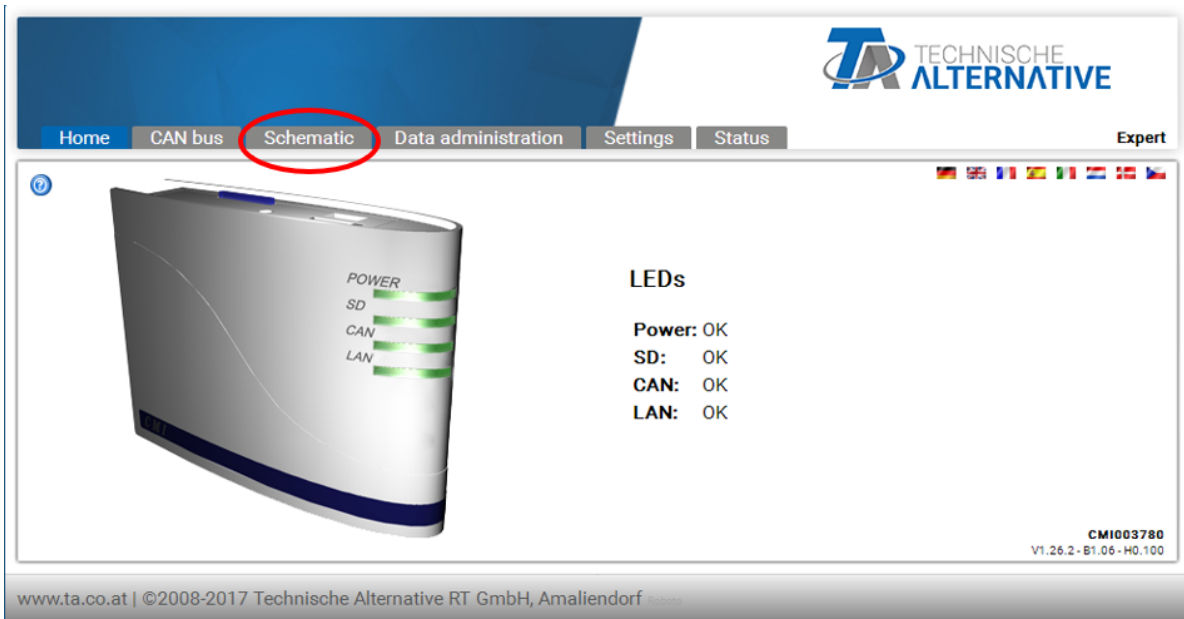

The operating status of the C.M.I. is shown with the LEDs. The current status of the LEDs is explained alongside.

For more detailed information, see the C.M.I. online manual (help.ta.co.at).

The (online) **scheme** is provided for the user here.

The user is able to view the sub-menus in "**Settings**" but cannot make any changes to them.

As with the function overview, the scheme may also comprise several pages.

Example of a simple scheme with 2 heating circuits

17.12.2015

13:00:43

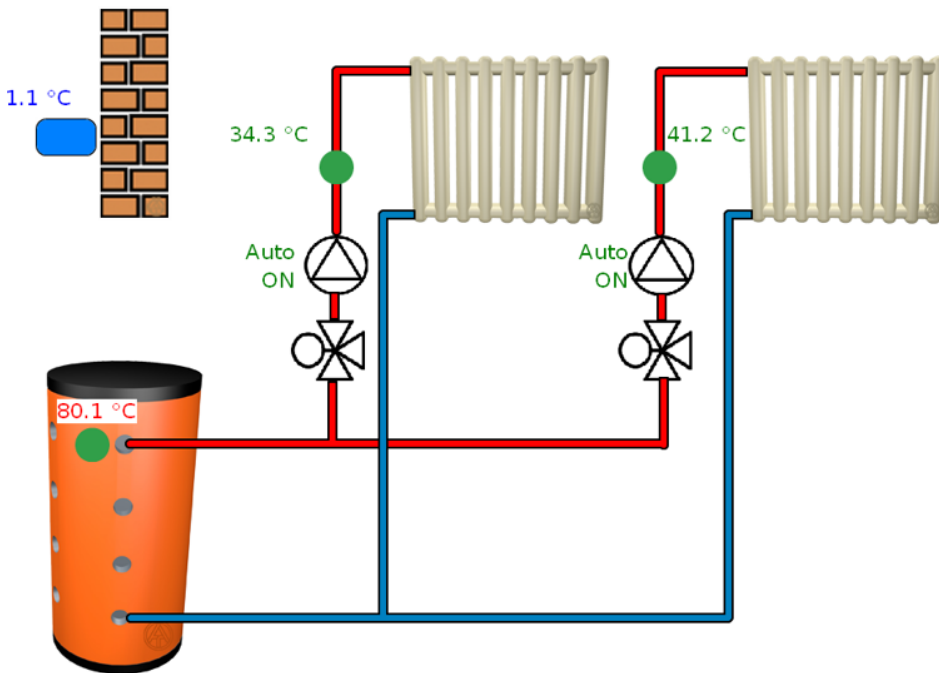

Changing a value

For the user to be able to change a value, it must have been enabled by the programmer for the user. A value can be changed by clicking on it.

Example:

Changing the output status of a pump from "Auto/ON" to "Manual/OFF"

When you click on a value, a selection box appears. Clicking "Auto" allows "Manual/OFF" to be selected.

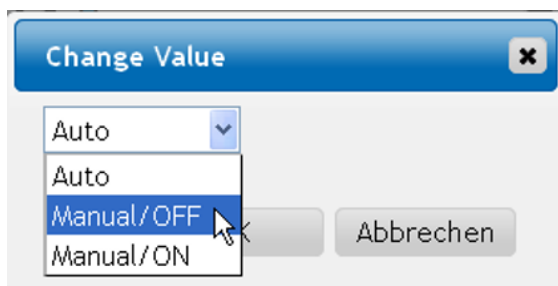

The procedure is then finished by clicking "OK".

The status of the output has now changed from Auto/ON to "Manual/OFF":

Before

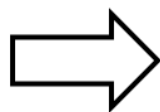

After



Warranty conditions

Note: The following warranty conditions do not in any way limit the legal right to warranty, but rather expand your rights as a consumer.

1. The company Technische Alternative RT GmbH provides a one-year warranty from the date of purchase for all the devices and parts which it sells. Defects must be reported immediately upon detection and within the guarantee period. Technical support knows the correct solution for nearly all problems. In this respect, contacting us immediately will help to avoid unnecessary expense or effort in troubleshooting.
2. The warranty includes the free of charge repair (but not the cost of on site troubleshooting, removal, refitting and shipping) of operational and material defects which impair operation. In the event that a repair is not, for reasons of cost, worthwhile according to the assessment of the Technische Alternative company, the goods will be replaced.
3. Not included is damage resulting from the effects of over-voltage or abnormal ambient conditions. Likewise, no warranty liability can be accepted if the device defect is due to: transport damage for which we are not responsible, incorrect installation and assembly, incorrect use, disregard of operating and installation instructions or incorrect maintenance.
4. The warranty claim will expire, if repairs or actions are carried out by persons who are not authorised to do so or have not been so authorised by us or if our devices are operated with spare, supplementary or accessory parts which are not considered to be original parts.
5. The defective parts must be sent to our factory with an enclosed copy of the proof of purchase and a precise description of the defect. Processing is accelerated if an RMA number is applied for via our home page www.ta.co.at. A prior clarification of the defect with our technical support is necessary.
6. Services provided under warranty result neither in an extension of the warranty period nor in a resetting of the warranty period. The warranty period for fitted parts ends with the warranty period of the whole device.
7. Extended or other claims, especially those for compensation for damage other than to the device itself are, insofar as a liability is not legally required, excluded.

Legal notice

These assembly and operating instructions are protected by copyright.

Use outside the copyright requires the consent of the company Technische Alternative RT GmbH.

This applies in particular to reproductions, translations and electronic media.

Technische Alternative RT GmbH

A-3872 Amaliendorf, Langestraße 124

Tel.: +43 (0)2862 53635

E-Mail: mail@ta.co.at

Fax +43 (0)2862 53635 7

-- www.ta.co.at --



©2020