

UVR610

FREELY PROGRAMMABLE
UNIVERSAL CONTROLLER

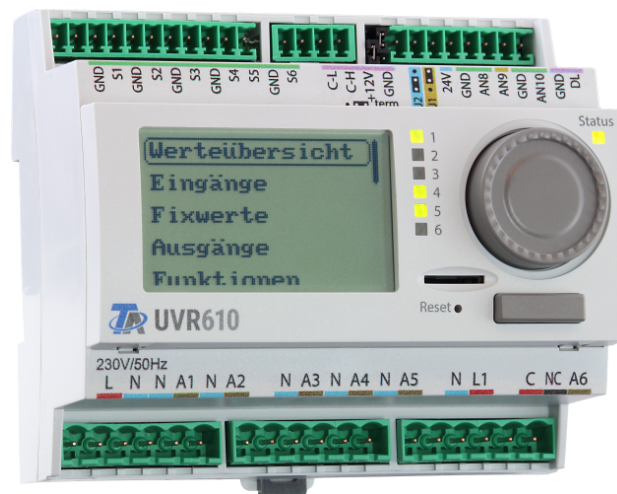

Programming:
Functions

Table of contents

General information	5
Schematic diagram of a function module	5
Selecting a function	5
Creating a new function	6
Sub-menu „fiD“ (designation)	7
Deleting a function	7
Input variables	8
System values	10
Parameters	11
Hystereses	11
Function quantities (units)	12
Outputs variables	14
Linking the output variables to outputs	15
Links	15
Function status	16
Analogue function	17
Heating demand	24
Cooling demand	28
DHW demand	31
Range function	35
Shading function	37
Individual room control	41
Energy manager	45
Energy meter	47
Gradient detection	49
Heating circuit control	58
Blind control	74
Calendar	77
Cascade	79
Curve function	85
Monitoring function	89
Cooling circuit control	91
Charging pump	95
Pasteurisation function	97
Output control	99
Logic function	101
Mathematics function	104
Message	107
Mixer control	112
PID control	114
Profile function	119

Table of contents

Sample & Hold	123
Time switch	125
Scaling function	131
Solar cooling	133
Solar control	134
Solar start / Drainback	137
Solar priority	140
Start-stop	142
Date-specific memory	143
Synchronisation	145
Timer function	146
Comparison function	151
Heat meter	152
Maintenance function	156
Conservatory function	158
Meter / Counter	163
DHW circulation	165

General information

Schematic diagram of a function module

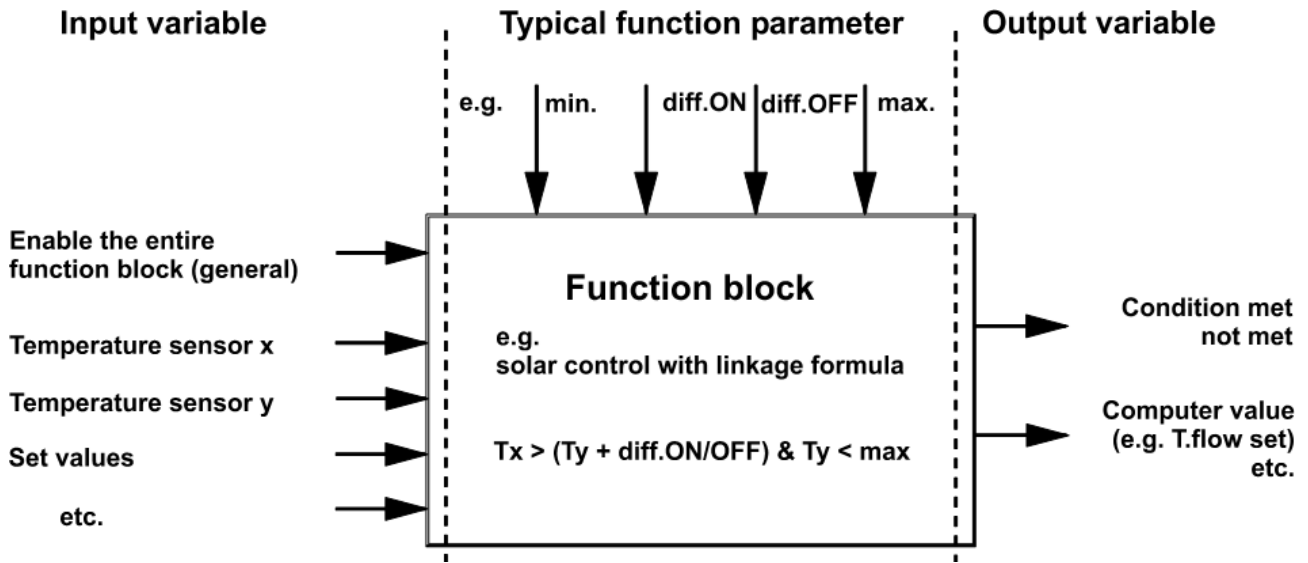

43 different functions are available on the controller.

Input variables are assigned to every function. The input variables of each function provide the module with all the data required for the internal decision.

Each function can be activated or deactivated with **Enable**.

Within each function, data and parameter settings are utilised in order to calculate the decisions and set values, which are then made available as output variables.

A function can therefore only perform tasks when connected by its respective input and output variables to other parts of the system (inputs, outputs, other functions, network).

Selecting a function

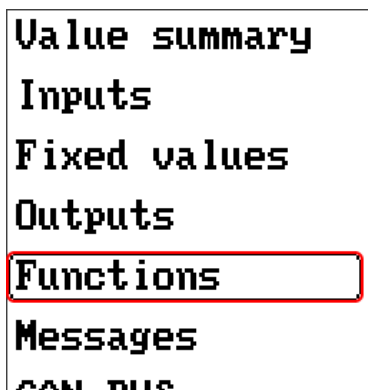

Following the selection in the main menu, the functions already programmed are displayed along with their designations.

Example of functions already programmed:

Functions	
1: Solar 1	+
2: Solar 2	+
3: Solar priority	+
New function	

Creating a new function

Functions	
1: Solar 1	+
2: Solar 2	+
3: Solar priority	+
New function	

Select **New function** and then select the function type you require.

Function 4	
Type	unused



Function 4	
Type	Analogue function
	Heating demand
	Cooling demand
	...

You can choose from 43 different functions and can create up to 128 functions. Functions can also be used multiple times.

Sub-menu „fiD“ (designation) FiD

In this sub-menu you can enter the function designation and can delete a function created previously.

Example: Analogue function

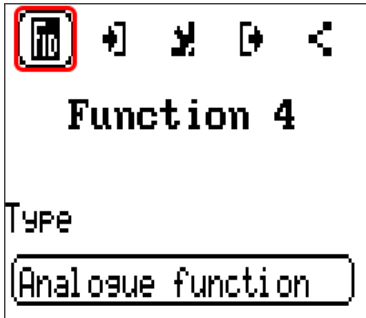

Enter the function designation by selecting a predefined designation from a general designation group or from user defined designations.

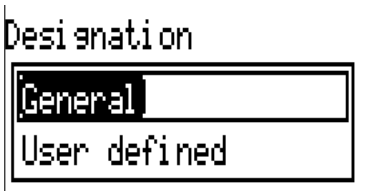

You can also assign a number from 1 to 16 to every designation.

Deleting a function



Here you have the option of deleting the function (last menu item).

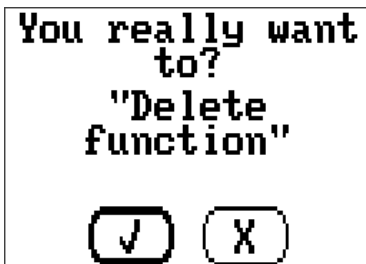

The function is not deleted until you answer a security question.

Answer by selecting either (= Yes) or (= No).

Input variables

Input variables constitute the link to sensors, to output variables from other function modules, or to other sources.



Selecting the icon  will display all the input variables of the function.

Selecting an input variable will display all available sources to choose from.

- User
- Inputs
- Outputs
- Functions
- Fixed values
- System values
- DL bus
- CAN bus analogue
- CAN bus digital

After selecting the source, you can make the additional selection within the required source.

Important: For every input variable, it is important to note the input signal type: **Analogue** (numeric value) or **Digital** (OFF/ON).

The descriptions of the function modules state the signal type for every input variable. Digital input signals (ON/OFF) can be applied as **standard** or **inverse**.

Every function module has the **Enable** input variable, which represents the fundamental activation of the entire function. It permits simple blocking or enabling of the entire module by means of a **digital signal** (ON/OFF).

Certain input variables are **always** required for the functioning of the module and **cannot** be set to **unused**. They appear with a **dark** background on the screen and are highlighted in the function **description**. Other input variables can be used optionally.

Example:

Eingangsvariablen
Freigabe
Zubringertemperatur
Referenztemperatur
Mindesttemp. Zubringer
Maximaltemp. Referenz

After selecting the source, you define which information from the source is transferred to the function.

Example: CAN bus analogue

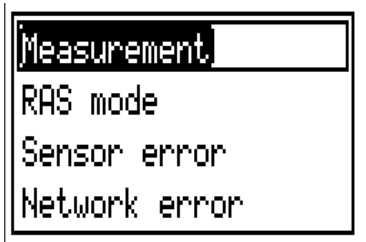

- **Measurement** – the value captured by the sensor
- **RAS mode** – - the following analogue values will be issued according to the setting of the switch on the room sensor (RAS, RASPT, RAS-PLUS, RAS-F):

Automatic	0
Standard	1
Setback	2
Standby	3
- **Sensor error** – digital value, ON if a sensor error occurs
- **Network error** – digital value, ON if a timeout is active (= error)

When linked to a **function**, the **output variables** are displayed for selection.

System values

The current system values are displayed in the "**System values**" menu.

The following system values can be selected as the **source** for function input variables and CAN and DL outputs:

- **General**
- **Time**
- **Date**
- **Sun**

General system values

When programmed accordingly, these system values allow monitoring of the controller system.

- **Controller start**
- **Sensor error DL**
- **Sensor error inputs**
- **Network error CAN**
- **Sensor error CAN**
- **Network error DL**

Controller start generates a 20 second pulse 40 seconds after the device is switched on or reset, and is used for monitoring the controller starts (e.g. after power failures) in the datalogging feature. The interval time in datalogging should be set to 10 seconds for these starts.

The **sensor errors** and **network errors** are global digital values (No/Yes) which are not connected to the error status of a specific sensor or network input.

If any one of the sensors or network inputs has an error, the status of the corresponding group changes from **No** to **Yes**.

Time system values

- **Second** (seconds of the current time)
- **Minute** (minutes of the current time)
- **Hour** (hour of the current time)
- **Second pulse**
- **Minute pulse**
- **Hour pulse**
- **Summertime** (digital value OFF/ON)
- **Time (hh:mm)**

Date system values

- **Day**
- **Month**
- **Year** (without the century)
- **Day of the week** (starting with Monday)
- **Calendar week**
- **Day of the year**
- **Day pulse**
- **Month pulse**
- **Year pulse**
- **Week pulse**

The pulse values generate a single pulse per time unit.

Sun system values

- **Sunrise** (time)
- **Sunset** (time)
- **Minutes until sunrise** (on the same day, does not go beyond midnight)
- **Minutes since sunrise**
- **Minutes until sunset**
- **Minutes since sunset** (on the same day, does not go beyond midnight)
- **Solar altitude** (see Shading function)
- **Direction of the sun** (see Shading function)
- **Solar altitude > 0°** (digital value ON/OFF)
- **High sun** (time)

Parameters

These parameters are values and settings which are specified by the user only.

They are settings which allow the user to adjust the controller to match the properties of the user's system. This menu may also be divided into further sub-menus, depending on the function.

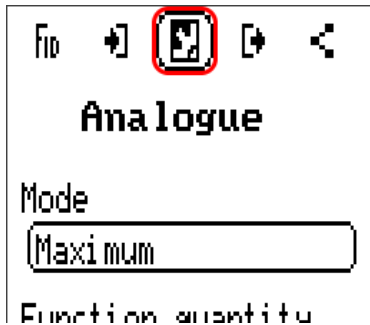

Function quantity

Mode

Maximum

Hystereses

Many parameters have adjustable start and stop differentials which have the effect of a switching hysteresis.

Example:

Demand temperature in the Heating demand function

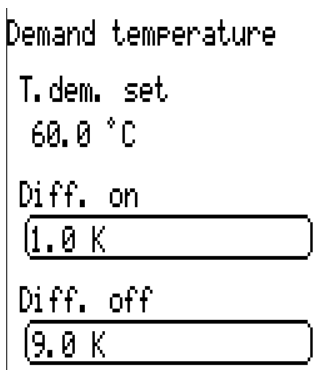

Demand temperature

T. dem. set
60.0 °C

Diff. on
1.0 K

Diff. off
9.0 K

Demand is triggered at T. dem. set + Diff. on (= 61 °C); shutdown is triggered at T. dem. set + Diff. off (= 69 °C).

The values of Diff. on and Diff. off can also be negative, but are always added to the set temperature.

Example of a negative Diff value:

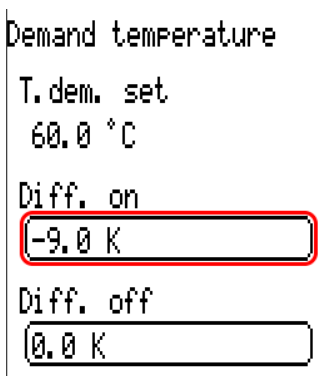

Demand temperature

T. dem. set
60.0 °C

Diff. on
-9.0 K

Diff. off
0.0 K

Here, demand is triggered at T. dem. set + Diff. on (= 51 °C); shutdown is triggered at T. dem. set + Diff. off (= 60 °C).

Schematic diagram of start and stop differentials for MAX and MIN thresholds

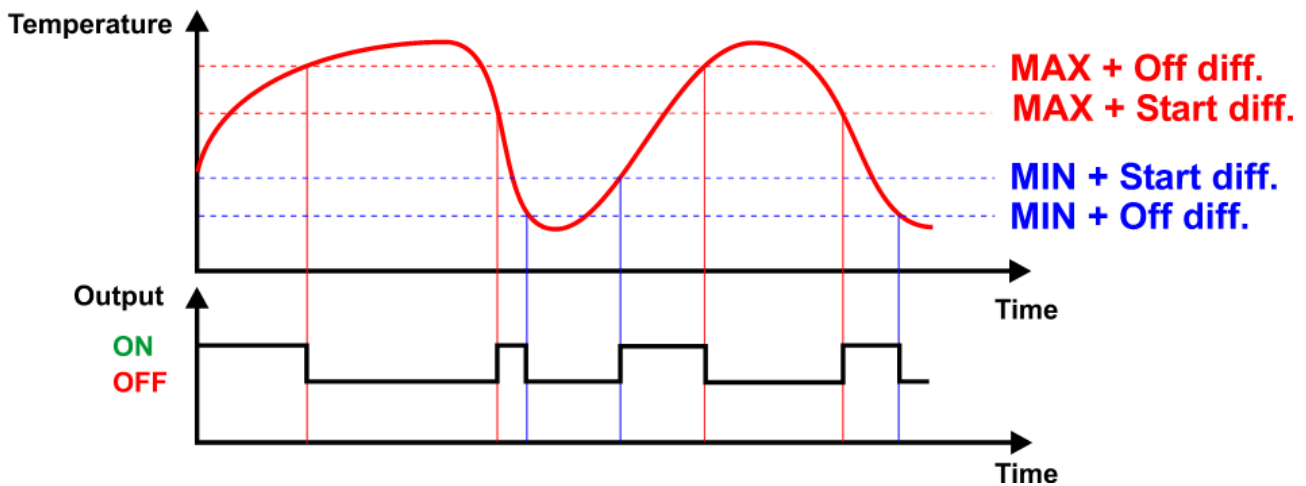

Function quantities (units)

In many functions you can choose from a wide range of function quantities. These function quantities have units with varying numbers of decimal places.

In all function calculations (exception: Curve function) the units are converted to the **smallest** unit in each case (l/min to l/h, min, h and days to s, MWh to kWh, m/s to km/h, m and km to mm, mm/h and mm/min to mm/day, m³/h and m³/min to m³/day)

Table of all function quantities

Function quantity	Decimal places	Function quantity	Decimal places
Dimensionless	0	Litre	0
Dimensionless (.1)	1	Cubic metre	0
Performance factor	2	Flow rate (all)	0
Dimensionless (.5)	5	Output [kW]	2
Temperature °C	1	Energy kWh	1
Global radiation [W/m ²]	0	Energy MWh	0
CO ₂ content [ppm]	0	Voltage [V]	2
Percent	1	Amperage [mA]	1
Absolute humidity [g/m ³]	1	Amperage [A]	1
Pressure [bar]	2	Resistance [kΩ]	2
Pressure [mbar]	1	Frequency [Hz]	2
Pressure [Pascal]	0	Number of pulses	0
Seconds	0	Speed (all)	0
Minutes	0	Euro	2
Hours	0	Dollar	2
Days	0	Degree (angle)	1

Example: If a value of 100.0% (Percent function quantity) is applied as Dimensionless in a function, the value will be the dimensionless size 1000.

Some functions have buttons at the end of the parameter menu which can be used to start the function and delete meter readings or messages.

Examples:

DHW demand, single loading start

0.0 K
Generator output
0.0 %
Single charging start

Heat meter, start calibration, delete calibration values, delete meter reading

value
0.0 K
Start calibration
Delete calib. values
Delete meter reading

Outputs variables

Output variables represent the results of the function module. They can be used to switch a hardware output directly, or can serve as the input variables for another module, or can be linked to CAN or DL bus outputs. A single output variable can also be linked **multiple times** to outputs, function input variables and/or CAN or DL bus outputs.

The number of output variables varies greatly depending on the function.

Example: In the **Comparison** function there are just 3 output variables; in the **Heating circuit** function there are 23.

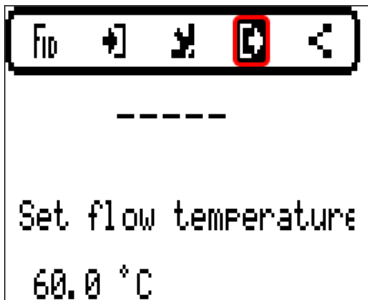

Some output variables **cannot** be linked to outputs; they cannot be selected.

Important: For every output variable, it is important to note the type of variable value when linking:
Analogue (numeric value) or Digital (OFF/ON).

Linking the output variables to outputs

Example: Linking the "Solar circuit" output variable to outputs 1 and 2

Select the output variable:

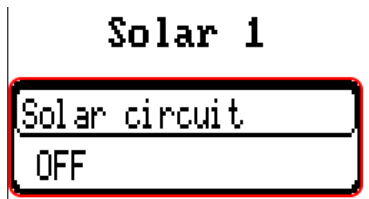

Select the two outputs:

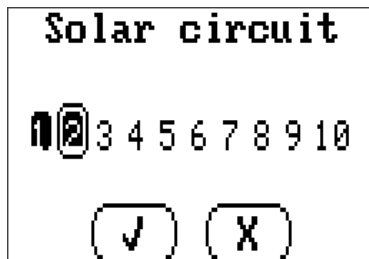

The selected outputs are highlighted.

Links



Links to other functions and CAN outputs are displayed here.

Example: Solar 1 function

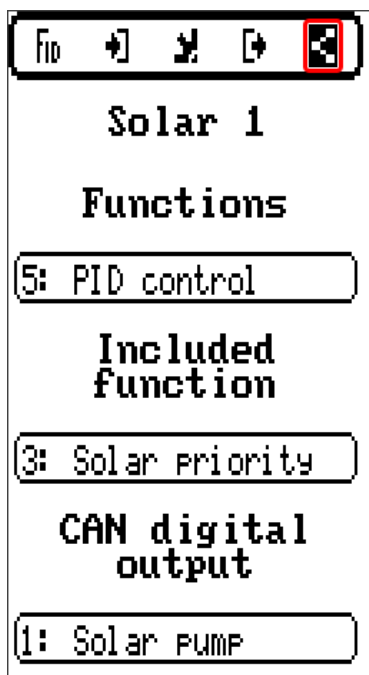

Functions: An output variable from **Solar 1** is linked to an input variable of the **PID control** function.

Included function: **Solar 1** is programmed as an **Included function** in the **Solar priority** function.

CAN digital output: An output variable from **Solar 1** is linked to **CAN digital output 1**.

You can go to the menu for a listed function or CAN output by tapping it and then confirming the prompt.



Function status

Functions	
1: Solar 1	

 Selecting the plus sign on an existing function displays the function status.

The values displayed are identical to the **output variables** of the function.

Example: Solar function

Functions	
1: Solar 1	
Solar circuit:	OFF
Maximum limit:	OFF
T.coll. <	
T.coll. max.:	ON
T.coll. >	
T.coll. min.:	ON
T.ref. < T.ref.	
max.:	ON
T.lim. < T.lim.	
max.:	
	

 If you tap the minus sign when the function status is open, the screen will close again.

Analogue function

Function description	
	The analogue function can perform various tasks related to switching input variables to output variables. The task to be executed is selected via the Mode parameter.
Minimum	The smallest value of all input variables is issued to the output variable Result .
Maximum	The largest value of all input variables is issued to the output variable Result .
Average	The arithmetic mean of all input variables is issued to the output variable Result (= sum of all input variables divided by number of linked input variables).
Sum	<p>The input variables are alternately added and subtracted according to the following formula:</p> $I1 - I2 + I3 - I4 + I5 - I6 + I7 - I8 + I9 - I10$ <p>Example: Simple addition of the two numbers $I1 + I3$ is produced by setting input variable $I2$ to User and entering zero for $I2$.</p>
Filter	<p>A time average value of input variable 1 is determined over the duration of the filter time (adjustable in the parameters).</p> <p>If Enable is switched off and back on again, the averaging will start with the input variable "Result (enable = off)".</p>
Multiplexer	<p>The input variable Multiplexer selection must be shown and connected. This determines which input variable is issued to Result.</p> <p>Example: If Multiplexer selection is set to 3 by means of a fixed value, the value of Input variable 3 is issued to the Result.</p>
Demultiplexer	<p>The input variable Multiplexer selection must be shown and connected. Only Input variable 1 is monitored ("Input variables 2-10" are ignored in this mode). Input variable 1 is issued to the output variable (Value 1-10) that corresponds to the Multiplexer selection.</p> <p>Example: If the multiplexer selection is set to 3 by means of a fixed value, input variable 1 is issued to Value 3.</p>
Ramp	This mode has its own section from page 22 onwards.

Input variables	
Enable	General enabling of the function (digital value ON/OFF)
Result (enable = off)	Analogue value for the result when Enable is OFF
Multiplexer selection	Analogue dimensionless value for selection of the input variables (Multiplexer) or output variables (Demultiplexer)
Input variable 1 – (maximum) 10	Analogue values for the calculation as per Mode. The number of input variables is defined in the Parameters menu or is determined by the Mode.
<ul style="list-style-type: none"> • If the Analogue function is blocked (Enable = Off), it issues a value which is either defined by the user with Result (enable = off) or which comes from a specific source. Enable can therefore be used to switch between analogue values. • If the source of an input variable is set to User, the user can specify an adjustable numeric value. • Digital signals can also be processed at the inputs: If the status is OFF, then zero is applied in the calculation as the value of that input variable; if the status is ON, then the offset value set in the Parameters menu is applied. 	

Parameters for <i>Minimum, Maximum, Average, Sum and Filter</i>	
Mode	Available for selection: <i>Minimum, Maximum, Average, Sum and Filter</i> (for explanation see below)
Function quantity	A wide range of function quantities are available, which are applied together with their unit and their decimal places.
No. of inputs (not shown in Filter mode)	Enter the number of input variables (maximum 10)
Output Value 1-10 (only displayed in "Minimum" and "Maximum" modes)	Choices: Variable + Offset, Variable + Offset = Result?
Filter time (shown only in Filter mode)	Enter the averaging time for calculating the average of the input variables over time.
Offset result (enable = off)	Optional: enter an offset value for the result if Enable = OFF
Offset 1 – (maximum) 10	Optional: enter offset values for each of the input variables
Variable (enable = off)	Display of the input variable for (Enable = Off) + Offset value
Value 1 – (max.) 10	Display of the input variables + Offset values
<ul style="list-style-type: none"> • The function generates a result as the output variable by processing the input variables (+ offset values) via the mode. The different modes are explained in the function description. • Value 1 - 10: If you select Variable + Offset, you will see the respective value of the input variables + offset shown in the output variables "Value 1 - 10". If you have selected Variable + Offset = Result?, a digital status of ON or OFF will be displayed in these output variables, whereby the highest or lowest value will be shown with ON and the other values with OFF, depending on the mode (Maximum/Minimum). 	

Output variables for <i>Minimum, Maximum, Average, Sum</i> and <i>Filter</i>	
Result	The result produced by the calculation; optional selection of an analogue output
Values 1-10	Display of the values for the input variables + offset or display of ON or OFF (only in "Minimum" and "Maximum" modes). Undefined input variables will be displayed as 0 °C or OFF.

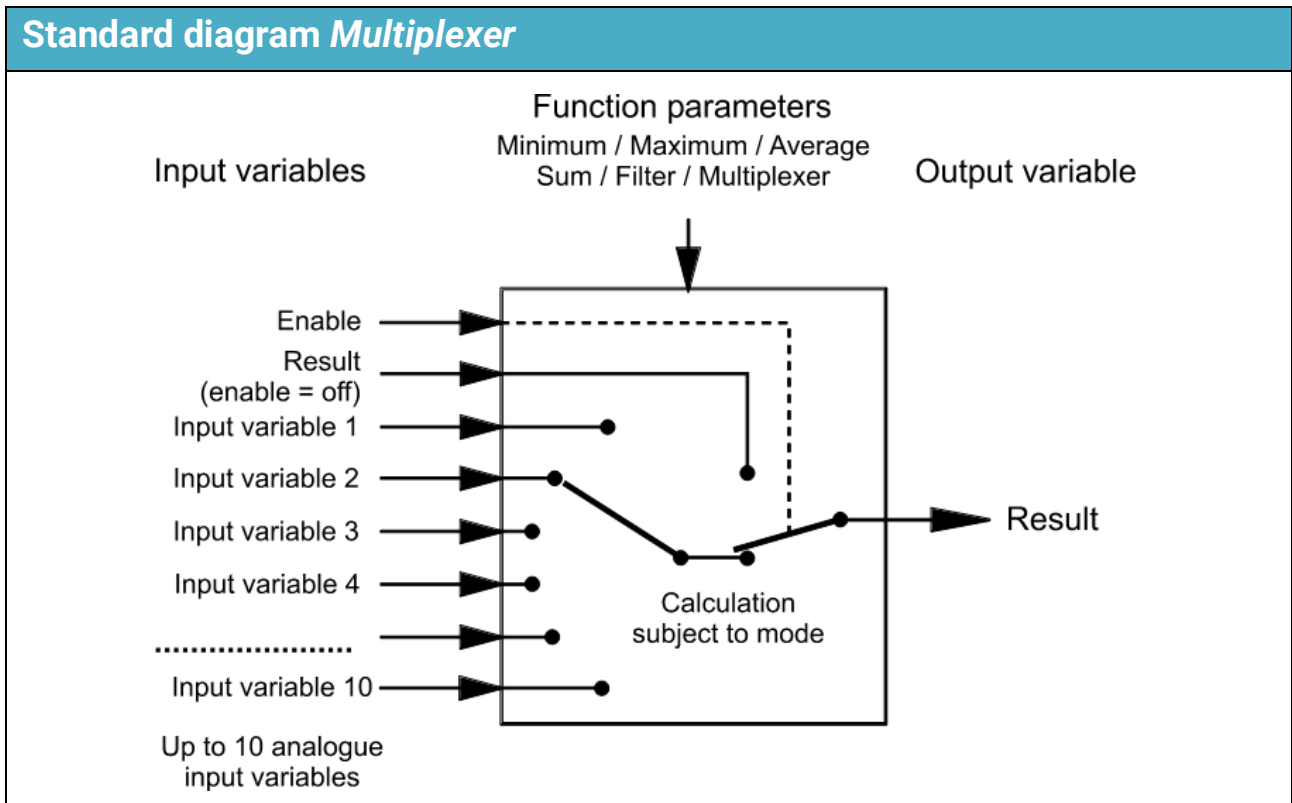

Parameters for <i>Multiplexer</i>	
Mode	Multiplexer
Function quantity	A wide range of function quantities are available, which are applied together with their unit and their decimal places.
No. of inputs	Enter the number of input variables (maximum 10)
Offset result (enable = off)	Optional: enter an offset value for the result if Enable = OFF
Offset multiplexer selection	Optional: enter an offset value for the value of the Multiplexer selection input variable
Offset 1 – (maximum) 10	Optional: enter offset values for each of the input variables
Variable (enable = off)	Display of the input variable for (Enable = Off) + Offset value
Value 1 – (max.) 10	Display of the input variables + Offset values

Output variables for *Multiplexer*

Result	The result produced by the Multiplexer function; optional selection of an analogue output
Value 1 - 10	Display of values for input variables + offset

- The Multiplexer function uses the Multiplexer selection variable (+ Offset value) to select the output variable from the input variables (+ Offset values).
Example: Anzahl der Eingangsvariablen = 4
 EingangsvARIABLE 1 = 10 °C
 EingangsvARIABLE 2 = 20 °C
EingangsvARIABLE 3 = 30 °C
 EingangsvARIABLE 4 = 40 °C
 Auswahl Multiplexer = 3
 keine Offsetwerte
 Ergebnis = **30 °C** (= EingangsvARIABLE 3)
- If the value of the Multiplexer selection variable (+ Offset value) is **zero or negative**, the value of input variable 1 will be issued.
- If the value of the Multiplexer selection variable (+ Offset value) is **greater** than the number of input variables, the value of the input variable with the highest ordinal number will be issued.

Standard diagram for *Demultiplexer*

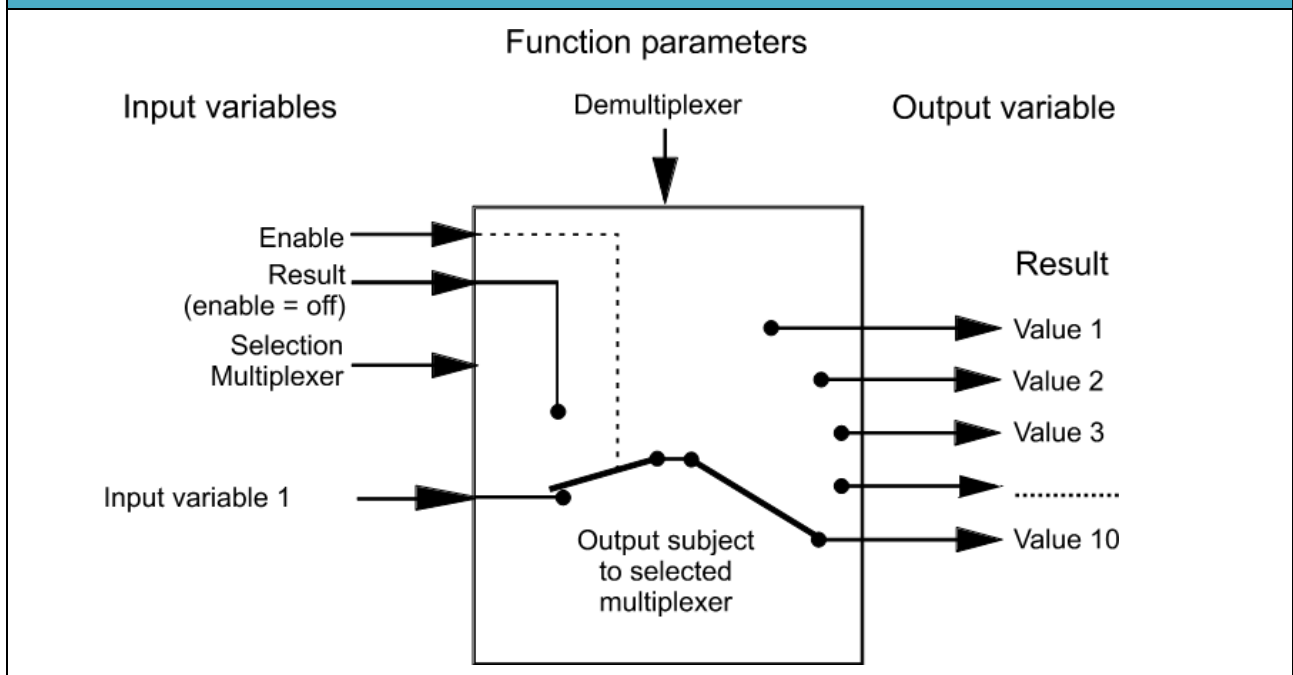

Parameter Demultiplexer	
Mode	Demultiplexer
Function quantity	A wide range of function quantities are available, which are applied together with their unit and their decimal places.
Offset result (enable = off)	Optional: enter an offset value for the value if Enable = OFF
Offset multiplexer selection	Optional: enter an offset value for the value of the Multiplexer selection input variable
Reset values	Available for selection: Yes / No If you select Yes and the Multiplexer selection input variable changes , the value of the output variable will be overwritten by the value of the variable for Result (enable = off) . If you select No and the Multiplexer selection input variable changes , the value of the output variable is retained.
Offset	Optional: enter an offset value for the input variable
Variable (enable = off)	Display of the input variable for (Enable = Off) + Offset value
Value 1	Display of the input variable + Offset value

Output variables for <i>Demultiplexer</i>	
Result	In Demultiplexer mode: display is always 0
Value 1 - 10	Display of the values according to the Demultiplexer function; optional selection of an analogue output
<ul style="list-style-type: none"> • The Demultiplexer requires only one input variable. That input variable is transferred to an output variable according to the value of Multiplexer selection + Offset value. • When the Multiplexer selection input variable changes, the value will either be saved or will be overwritten with the value of the Result (enable = off) input variable, depending on the status of the Reset values parameter. • If Enable is set to OFF, the value for Result (enable = off) will be issued as the output for all 10 values. This can therefore be used as a way of resetting saved values. • If the value of the Multiplexer selection input variable (+ Offset value) is zero, negative or greater than 10, the values of the output variables will not be changed. 	

Standard diagram for Ramp

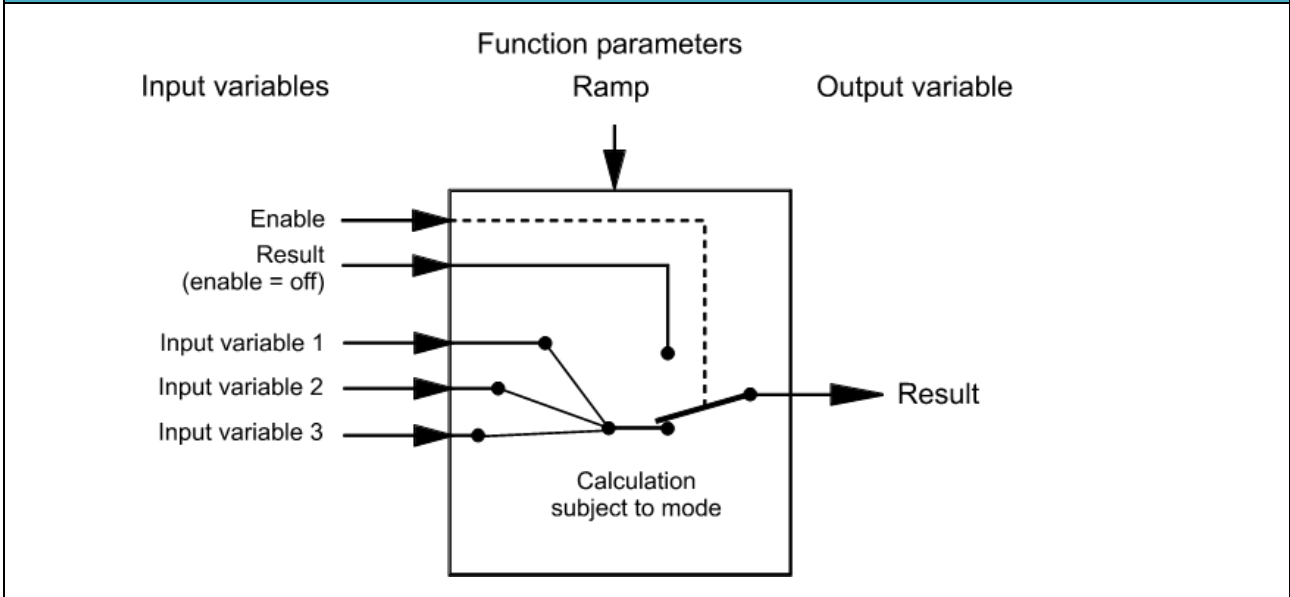

Function description Ramp

In Ramp mode, the **result** is constantly aligned with the value of **input variable IV1**. With the help of input variables 2 and 3 and the **interval time**, the slope of this alignment is specified for a rising or falling value.

Schematic diagrams

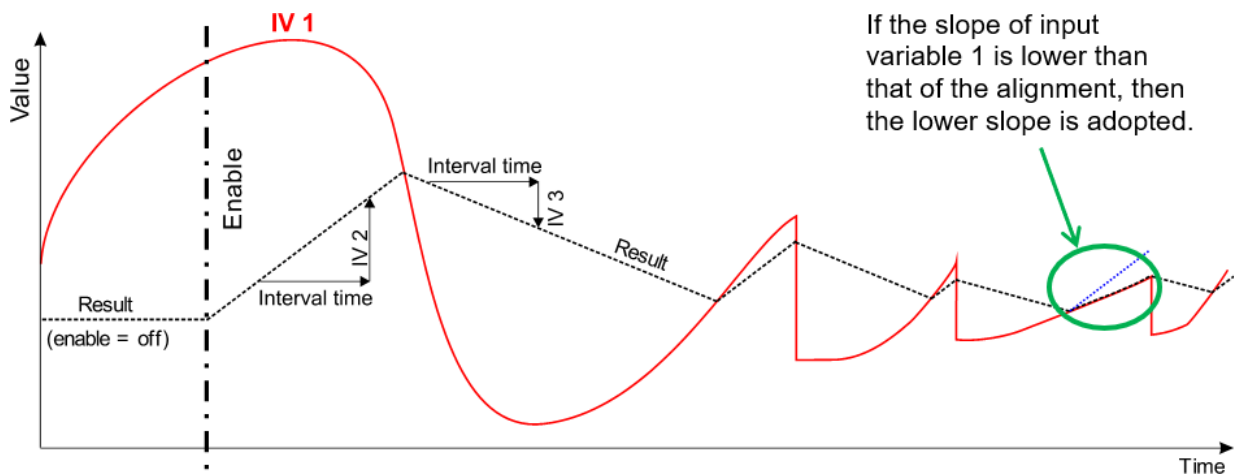

Characteristics in relation to sudden changes in input variable IV1

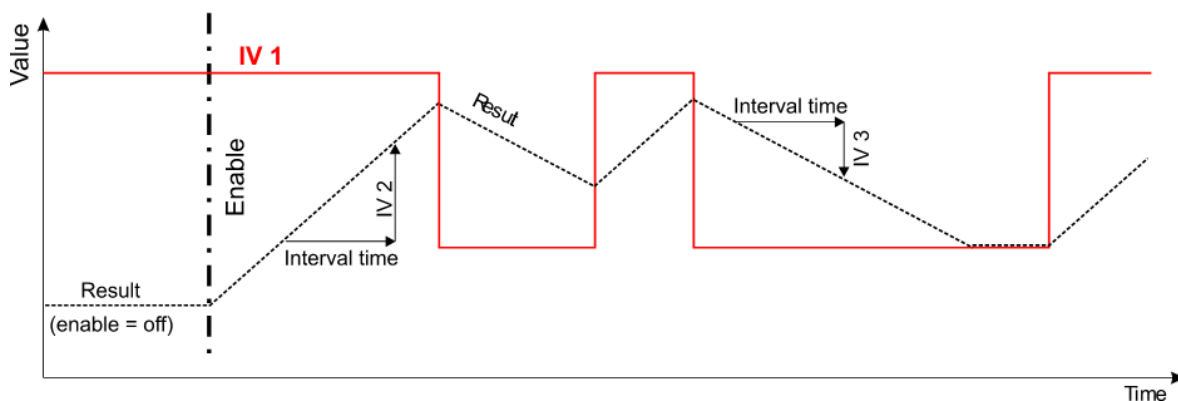

Input variables for *Ramp*

Enable	General enabling of the function (digital value ON/OFF)
Result (enable = off)	Analogue value for the result when Enable is OFF
Multiplexer selection	No effect in this mode
Input variable 1	Analogue value for the calculation according to mode (set value)
Input variable 2	Analogue differential value for rising input variable 1
Input variable 3	Analogue differential value for falling input variable 1

- **Ramp** mode requires **three** input variables.
- If the Analogue function is blocked (Enable = Off), it issues a value which is either defined by the user with **Result (enable = off)** or which comes from a specific source.
- If the source of an input variable is set to **User**, the user can specify an adjustable numeric value.
- With input variables 1 - 3 **digital** signals can also be processed: If the status is **OFF**, then **zero** is applied in the calculation as the value of that input variable (without adding the offset value); if the status is **ON**, then the **offset value** set in the Parameters menu is applied.

Parameters for *Ramp*

Mode	Ramp
Function quantity	A wide range of function quantities are available, which are applied together with their unit and their decimal places.
Interval time	Entry of the time within which the result should change in accordance with input variables 2 (rising) or 3 (falling).
Offset result (enable = off)	Optional: enter an offset value for the result if Enable = OFF
Offset 1 - 3	Optional: enter offset values for each of the input variables
Variable (enable = off)	Display of the input variable for (Enable = Off) + Offset value
Value 1 - 3	Display of the input variables + Offset values

Output variables *Ramp*

Result	Result of the calculation according to Ramp mode
Value 1 - 10	Display of the input variables + Offset values

Heating demand

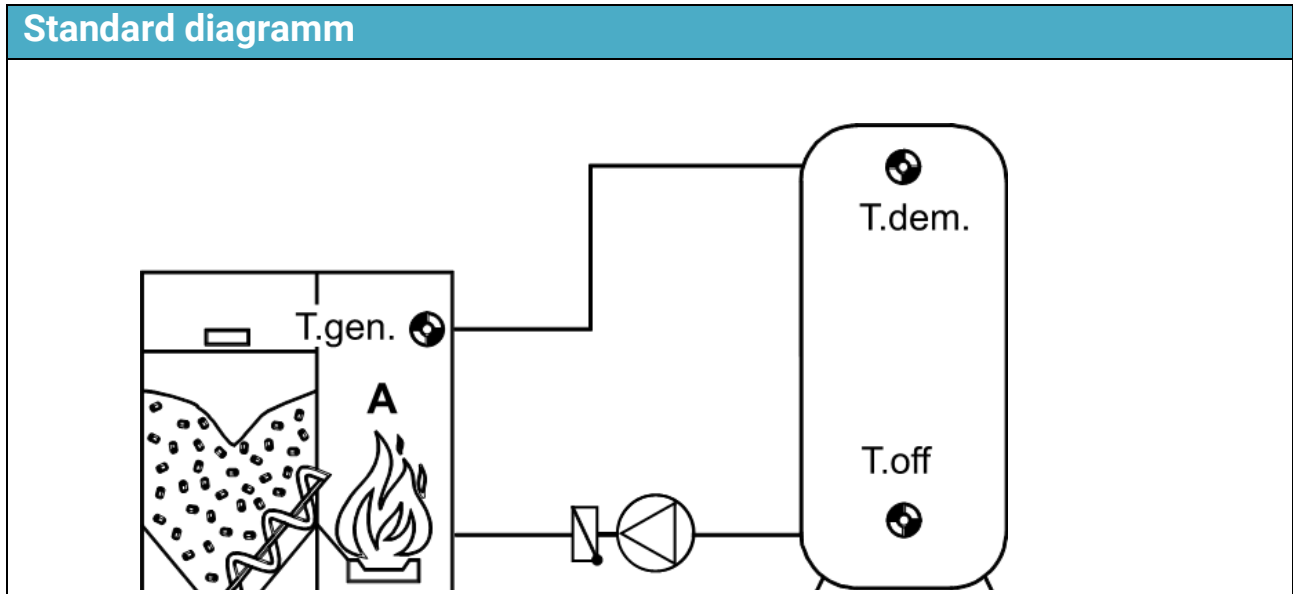

Function description

The heating demand starts when the temperature in the cylinder (demand temperature, T.dem.) falls below the Set demand temperature and stops when the temperature in the lower section of the cylinder (shutdown temperature, T.off) exceeds the Set shutdown temperature. If the demand sensor T.dem. is used as a boiler sensor (without T.off), the result is modulating boiler operation. An optional maximum temperature can be specified for boiler A (the heat generator).

Input variables

Enable	General enabling of the function (digital value ON/OFF)
Demand temp.	Analogue input signal for the demand temperature
Shutdown temperature	Analogue input signal for the shutdown temperature
Set demand temperature	Analogue value specifying the set demand temperature
Set shutdown temperature	Analogue value specifying the set shutdown temperature
Shortfall	Analogue percentage specifying the shortfall in Eco mode (see Eco mode)
Generator temperature	Analogue input signal for the temperature of the heat generator
Maximum temp generator	Analogue value specifying the maximum heat generator temperature
Charge once	Digital input signal ON/OFF (pulse): Charging the cylinder even when the temperature has not fallen below the demand temperature.
Set temperature for charge once	Minimum temperature for "Charge once"

- If you want the set temperatures for demand, shutdown and maximum heat generator temperature to be user-defined settings (fixed thermostat thresholds), specify *User* as the source and enter the required value.
- Charge once:** If a short ON signal (e.g. pulse from a pushbutton) is sent, charging is initiated **once** up to either "T.off set", "Set temperature charge once" or "T.dem. min + Diff. off", whichever is higher. "Charge once" can also be started from the **Parameter menu**.

Input variables

ECO MODE

The Eco mode is referenced to a **period** by the **Shortfall**. The shortfall coefficient always refers to a period of **60 minutes**. For a demand temperature T_{dem} of 50 °C, a shortfall of 20 % has the following effect: demand after 30 minutes below 30 °C or after one hour below 40 °C (= 20 %) or after two hours below 45 °C. Under 30 minutes the threshold value remains the same.

Formula: $dT * dt = \text{shortfall} * \text{set demand temperature value} = \text{constant}$

Example:

Demand temperature = 50°C

Unterdeckung = 20%

=> 20% of 50°C = 10K

$dt = 30\text{min} \Rightarrow dT = 20\text{K}$

$dt = 60\text{min} \Rightarrow dT = 10\text{K}$

$dt = 120\text{min} \Rightarrow dT = 5\text{K}$

$dt = 240\text{min} \Rightarrow dT = 2,5\text{K}$

$dt = 480\text{min} \Rightarrow dT = 1,25\text{K}$

$dt = 1440\text{min} \Rightarrow dT = 0,42\text{K}$

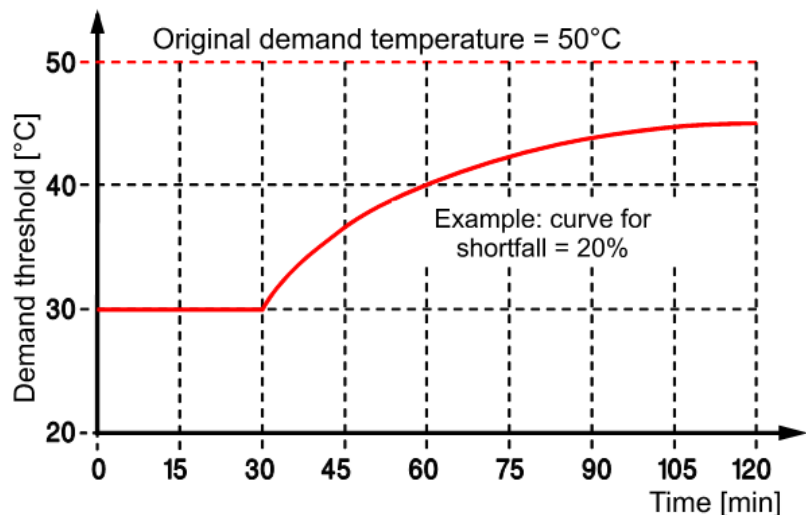

The demand status changes to ON if the actual demand temperature is 20 K below the set value for 30 minutes or if the actual demand temperature is 0.42 K below the set value for 1440 minutes (= 1 day).

The curve is limited at the point where it falls to more than twice the shortfall * the set demand temperature value (which equates to the value at 30 min). If the differential between the set demand value and the actual value of the demand temperature is greater than twice the shortfall * the set demand temperature value, the burner starts immediately (such as when the heating circuit changes over from setback to standard mode or when a shutdown condition is no longer met and the heating circuits start up again).

The heating demand is terminated when, in cases where **one** sensor is used, the temperature $T_{dem. set} + \text{Diff. off}$ is exceeded or, in cases where **two** sensors are used, the temperature $T_{dem. set} + \text{Diff. off}$ is exceeded at the shutdown sensor.

In practice, neither the demand temperature nor the set value will be constant. The difference between the two values normally becomes ever greater over time, so an ever greater product of $dT * dt$ is continually added to the sum register and compared to the curve. This will be the case unless, for example, the heating circuits change over from standard mode to setback or if the heating circuit pump stops completely due to a shutdown condition, etc. However, in such cases the energy is saved that the burner would have consumed if it had started immediately when the demand temperature fell below the set value. At certain intervals, the program calculates the differential between the set demand value and the actual value of the demand temperature. If that sum is greater than the product of the shortfall * the set demand temperature value with reference to one hour – and allowing for the immediate starting of the burner when the curve is below twice the shortfall – then the burner starts.

Parameter	
Demand temperature T.dem. set Diff.on Diff. off (shown only if the T.off sensor is not defined)	Display: Start threshold at the T.dem. sensor Start differential for T.dem. set Stop differential for T.dem. set
Shutdown temperature (shown only if the T.off sensor is defined) T.off set Diff. off	Display: Shutdown threshold at the T.off sensor Stop differential for T.off set
Low end temperature T.dem. min.	Heating demand if the demand temperature "T.dem. set" or shutdown temperature "T.off set" falls below this value (only effective if T.dem. set > +5 °C)
Generator temperature (shown only if the T.gen. sensor is defined) T.gen. max. Diff. on Diff. off	Display: Limit value for the maximum generator temperature Start differential for T.gen. max. Stop differential for T.gen. max.
Minimum runtime Generator	Specifies the minimum ON time
<ul style="list-style-type: none"> • Starting the burner by demand from one sensor and shutting it down by another is called using a holding circuit. Start threshold = Set demand temperature + Diff. on at the T.dem. sensor Shutdown threshold = Set shutdown temperature + Diff. off at the T.off sensor • For a control function with start and shutdown thresholds on just one sensor, the Shutdown temperature input variable must be set to unused. If the boiler sensor is entered instead of the cylinder sensor, the result is modulating boiler operation. Set demand temperature thereby receives a start differential and a stop differential alongside its threshold value: Start threshold = Set demand temperature + Diff. on Shutdown threshold = Set demand temperature + Diff. off • A minimum temperature can be specified using the low end temperature T.dem. min. If the set temperature for demand or shutdown is below that value, the low end temperature is applied as the threshold value. The low end temperature is only effective if the relevant set temperature is > 5 °C. A value > 30 °C is only useful if the function is being used for modulating boiler operation. In that case, the start and shutdown thresholds apply to the T.dem. sensor. • If the generator temperature (boiler temperature) exceeds the value T.gen. max. + Diff. off, demand will not be permitted and will be switched off even if the minimum runtime has not yet finished. Demand will not be re-enabled until the temperature falls below T.gen. max. + Diff. on. The minimum runtime counter will then restart. 	

Output variables	
Demand	Demand status ON/OFF; selection of the output
T.dem. < T.dem. set	Status ON if the demand temperature T.dem. is lower than the set temperature T.dem. set + Diff. on.
T.off < T.off set	Status ON if the shutdown temperature T.off is lower than the set temperature T.off set + Diff. off.
Low end temp. effective	Status ON if the set demand value falls below the low end temperature T.dem. min., regardless of the demand status.
Minimum runtime ctr	Display of the remaining runtime for the minimum runtime, in seconds
T.gen. < T.gen. max.	Status ON if the boiler temperature is lower than the maximum temperature T.gen. max. + Diff. off.
Effective set temperature	Display of the set temperature currently in use. If the heating demand is not active, the output is 5 °C.
<ul style="list-style-type: none"> • If there is no shutdown sensor, the output variable T.off < T.off set is switched by means of the threshold T.dem. set + Diff. off. • If there is no generator sensor, the output variable T.gen. < T.gen. max. is always set to status ON. 	

Cooling demand

Standard diagram

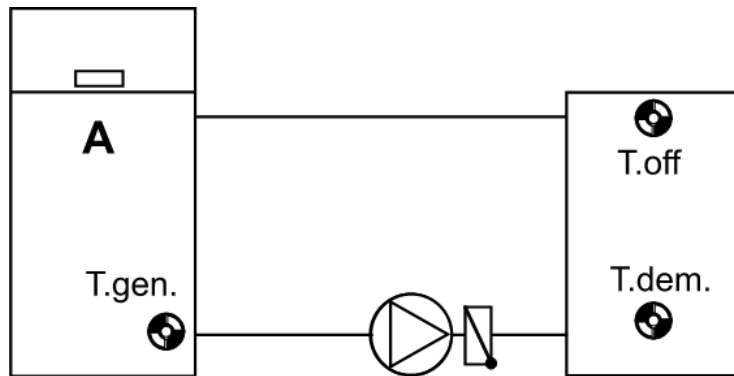

Function description

Cooling demand starts when the demand temperature T.dem. exceeds the Set demand temperature and stops when the shutdown temperature T.off falls below the Set shutdown temperature. If the T.off sensor is not used, both demand and shutdown are triggered via the T.dem. sensor. An optional minimum temperature can be specified for cooling device A (the generator).

Eingangsvariablen

Enable	General enabling of the function (digital value ON/OFF)
Demand temp.	Analogue input signal for the demand temperature
Shutdown temperature	Analogue input signal for the shutdown temperature
Set demand temperature	Analogue value specifying the set demand temperature
Set shutdown temperature	Analogue value specifying the set shutdown temperature
Generator temperature	Analogue input signal for the temperature of the heat generator
Min. temp. generator	Analogue value specifying the minimum temperature of the generator

- If you want the set temperatures for demand, shutdown and minimum generator temperature to be user-defined settings (fixed thermostat thresholds), specify *User* as the source and enter the required value.

Parameters	
Demand temperature T.dem. set Diff. on Diff. off (shown only if the T.off sensor is not defined)	Display: Start threshold at the T.dem. sensor Start differential for T.dem. set Shutdown differential for T.dem. set
Shutdown temperature (shown only if the T.off sensor is defined) T.off set Diff. off	Display: Shutdown threshold at the T.off sensor Shutdown differential for T.off set
Low end temperature T.dem. max.	Cooling demand starts if the T.dem. sensor captures a higher value (only effective if T.dem. set < +50 °C)
Generator temperature (shown only if the T.gen. sensor is defined) T.gen. min. Diff. on Diff. off	Display: Limit value for the minimum generator temperature Start differential for T.gen. min. Stop differential for T.gen. min.
Minimum runtime Generator	Specifies the minimum ON time
<ul style="list-style-type: none"> • Starting demand by one sensor and stopping it by another is called using a holding circuit. Start threshold = Set demand temperature + Diff. on at the T.dem. sensor Shutdown threshold = Set shutdown temperature + Diff. off at the T.off sensor • For a control function with start and shutdown thresholds on just one sensor, the Shutdown temperature input variable must be set to unused. Set demand temperature thereby receives a start differential and a stop differential alongside its threshold value: Start threshold = Set demand temperature + Diff. on Shutdown threshold = Set demand temperature + Diff. off • A maximum temperature can be specified using the low end temperature T.dem. max. If the set temperature for demand or shutdown is above that value, the low end temperature is applied as the threshold value. The low end temperature is only effective if the relevant set value is < 50 °C. • If the generator temperature (cooling device temperature) falls below the value T.gen. min. + Diff. off, demand will not be permitted and will be switched off even if the minimum runtime has not yet expired. Demand will not be re-enabled until the temperature exceeds T.gen. min. + Diff. on. The minimum runtime counter will then restart. 	

Output variable	
Demand	Demand status ON/OFF; selection of the output
T.dem. > T.dem. set	Status ON if the demand temperature T.dem. is higher than the set temperature T.dem. set + Diff. on.
T.off > T.off set	Status ON if the shutdown temperature T.off is higher than the set temperature T.off set + Diff. off.
Low end temp. effective	Status ON if the set demand value exceeds the low end temperature T.dem. max., regardless of the demand status
Minimum runtime ctr	Display of the remaining runtime for the minimum runtime, in seconds
T.gen. > T.gen. min.	Status OFF for as long as shutdown via generator temperature is in effect
<ul style="list-style-type: none"> • If there is only a demand sensor, the output variable T.off > T.off set is switched by threshold T.dem. set + Diff. off. • If there is no generator sensor, the output variable T.gen. > T.gen. min. is always set to status ON. 	

DHW demand

Standard diagram

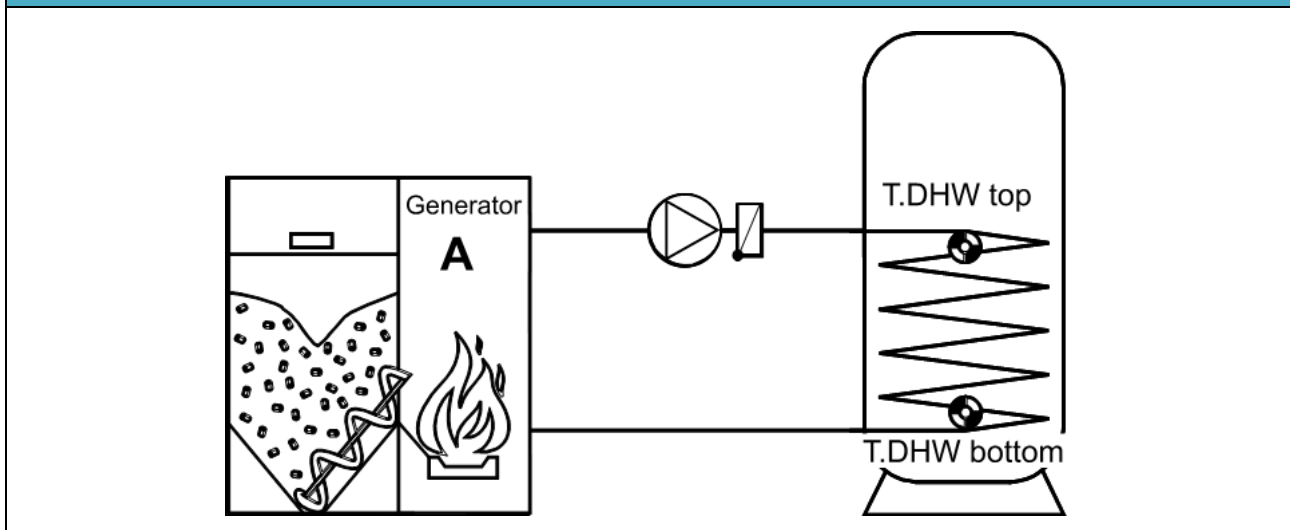

Function description

The heating demand is started when the temperature at the **top** of the cylinder (DHW temperature **T.DHW top**) falls below the set temperature defined by the time condition. Demand stops when the temperature at the **bottom** of the cylinder (DHW temperature **T.DHW bottom**) exceeds the set temperature defined by the time condition.

However, it is also possible to start and stop demand solely by means of the top sensor **T.DHW top**.

Input variables	
Enable	General enabling of the function (digital value ON/OFF)
DHW temp. top	Analogue input signal for the top cylinder temperature
DHW temp. bottom	Optional: Analogue input signal for the bottom cylinder temperature
Time condition status	Digital input signal, ON/OFF (e.g. from the Time switch function)
Set temperature top	Analogue value specifying the DHW temperature required at the top
Set temperature bottom	Analogue value specifying the DHW temperature required at the bottom
Minimum temperature top	Analogue value specifying the minimum temperature required at the top outside the time window
Minimum temperature bottom	Analogue value specifying the minimum temperature required at the bottom outside the time window
Offset set temperature top	Optional: Analogue value specifying an offset for Set temperature top (not applied to Minimum temperature top)
Offset set temperature bottom	Optional: Analogue value specifying an offset for Set temperature bottom (not applied to Minimum temperature bottom)
External switch	Digital input signal, ON/OFF, for changeover between standard mode as per time program and demand only to maintain T.DHW min.
Charge once	Digital input signal, ON/OFF: Charge the cylinder at any time, even outside the time window, at the push of a button
Finish charging	Digital input signal, ON/OFF, for complete charging of the cylinder
Set temperature for charging once	Minimum temperature for "Charge once"
<ul style="list-style-type: none"> • Demand can be started and stopped either by just one sensor (top) or by two sensors (top and bottom). If the sensor for DHW temperature bottom is set to unused, demand is started and stopped by means of DHW temperature top only. • If you want the set values for demand, shutdown and minimum temperatures to be user-defined settings (thermostat thresholds), specify User as the source and enter the required value. • The "Time condition status" allows you to switch between the top/bottom set values (time condition ON) and the minimum top or bottom set values (time condition OFF). • The set temperatures can also come from the Time switch function. However, note that the effective set temperature when Time condition status is OFF is the minimum temperature. Therefore if time conditions are not required, the Time condition status must be changed by User to ON. • If the set temperatures are below the minimum temperatures, the minimum temperatures are applied as the lowest limit. • The Offset values do not apply to the minimum temperatures. • The External switch input variable allows you to use another function (e.g. Calendar function) or a manual switch (digital input) to switch between standard mode as per time program (status of the external switch: OFF) and demand to maintain the minimum temperature only (status of the external switch: ON) (application: e.g. holidays). • Charge once: If a short ON signal (e.g. pulse from a pushbutton) is sent, charging is initiated once until either ("T.DHW min.", "Set temperature charge once" or "T.DHW set") + "Diff. off" is reached, whichever is higher. "Charge once" works independently of "Time condition status" or the status of the external switch. It can also be started from the Parameter menu. • Finish charging: If the input variable is set to OFF and the cylinder is being charged to T.DHW set, when the time window ends (changeover to T.DHW min.) the function will change over immediately to the set temperature T.DHW min. On the other hand, if the input variable is set to ON the function will finish charging the cylinder to T.DHW set and only then will it change over to the set temperature T.DHW min. 	

Parameters									
T.DHW top T.DHW min. top T.DHW set top Diff.on Diff. off (shown only if no second bottom sensor is defined)	Display of the required minimum temperature top (outside the time window) Display of the required DHW temperature top Start differential for T.DHW set top / T.DHW min. top Stop differential for T.DHW set top / T.DHW min. top								
T.DHW bottom (shown only if a second bottom sensor is defined) T.DHW min. bottom T.DHW set bottom Diff. off	Display of the required minimum temperature bottom (outside the time window) Display of the required DHW temperature bottom Stop differential for T.DHW set bottom / T.DHW min. bottom								
Generator output	Specifies the output of the heat generator [e.g. boiler] as % (to one decimal place)								
Single charging start	If this button is pressed outside a time window, the cylinder is charged once up to the temperature T.DHW set + Diff. off . "Charge once" is not possible if the external switch is set to ON.								
<ul style="list-style-type: none"> • Starting demand by one sensor and stopping it by another is called using a holding circuit. Start threshold = set value + Diff. on at the sensor Stop threshold = set value + Diff. off at the sensor Example: <table style="margin-left: 20px; border: none;"> <tr><td>T.DHW set top</td><td>= 40°C</td></tr> <tr><td>T.DHW set bottom</td><td>= 60°C</td></tr> <tr><td>Diff. on</td><td>= 8.0 K</td></tr> <tr><td>Diff. off</td><td>= 1.0 K</td></tr> </table> In other words, if the temperature falls below T.DHW 48 °C (= 40 °C + 8.0 K) at the top sensor, the output becomes active, and it is deactivated if the temperature exceeds 61 °C (= 60 °C + 1.0 K) at the bottom sensor. 		T.DHW set top	= 40°C	T.DHW set bottom	= 60°C	Diff. on	= 8.0 K	Diff. off	= 1.0 K
T.DHW set top	= 40°C								
T.DHW set bottom	= 60°C								
Diff. on	= 8.0 K								
Diff. off	= 1.0 K								

Output variables	
Effective set temperature	Output of the effective (= current) top set temperature (dependent on the "Time condition status" or the status of the external switch), or if "Charge once" is activated, of the "Set temperature charge once". If the DHW demand is not active, the output is 5 °C.
Set temperature	The set temperature top (T.DHW set top + offset value)
Demand	Demand status ON/OFF; selection of the output
Generator output	The output of the heat generator [e.g. boiler] as % to one decimal place
T.DHW top < T.DHW set top	Status ON if the temperature top is lower than the effective set temperature as per time program + Diff. on
T.DHW bottom < T.DHW set bottom	Status ON if the temperature bottom is lower than the effective set temperature as per time program + Diff. off (If there is no bottom sensor, the status is always ON.)
<ul style="list-style-type: none"> • The effective set temperature currently defined by the time window is available as an output variable. If demand switches off, this output is 5 °C. • The function makes the thermal output of the heat generator available as an output variable. This variable can be assigned to an analogue output (analogue output 0-10 V or PWM). That output could then be used to control the burner's thermal output, for example (assuming you have the required burner technology). This is recommended if an unfavourable ratio of burner output to heat exchanger output causes the excess temperature cut-out in the boiler to trip when the boiler is running at its full output. Scaling of the analogue output: $0 = 0.00 \text{ V} / 1000 = 10.00 \text{ V}$ 	

Range function

Function description

In the Range function, you can define up to 10 thresholds. A defined reference value is compared with those thresholds. The output variables indicate the status of each of the ranges, according to mode.

Binary decoder mode decodes single bits from a numerical value.

Input variables Mode Ranges

Enable	General enabling of the function (digital value ON/OFF)
Reference value	Analogue input signal for the reference value being monitored
Threshold A – (max.) J	Selection of the required range boundaries (thresholds)

Parameters Mode Ranges

Mode	Available for selection: <i>only range</i>, <i>Ranges >= value</i>, <i>Ranges <= value</i>, <i>Ranges > value</i>, <i>Ranges < value</i>
Function quantity	Select the function quantity. A wide range of function quantities are available, which are applied together with their unit and their decimal places.
No. of thresholds	Enter the number of thresholds, up to 10
Diff. on Diff. off	Start differential for the thresholds Stop differential for the thresholds

- The switching thresholds are each divided into a start differential and a stop differential. If the value is **rising**, the start differential applies (threshold + **Diff.on**); if the value is **falling**, the stop differential applies (threshold + **Diff. off**).
- Explanation of the three different modes:
 - only range** mode: Only the status of the range applicable to the value will be switched on.
 - Ranges >= value** mode: The range applicable to the value will be switched on, along with all ranges above.
 - Ranges <= value** mode: The range applicable to the value will be switched on, along with all ranges below.
 - Ranges > value** mode: Only the ranges above will be switched on.
 - Ranges < value** mode: Only the ranges below will be switched on.
- If Diff. on and Diff. off are set to 0, the thresholds will have no hysteresis. The status will be switched immediately a range boundary is reached. This setting should not be used for sensor values (e.g. from temperature sensors). If the value is rising, it must exceed a threshold in order for the status of the next range up to be switched on; if the value is falling, it must fall below a threshold in order for the status of the next range down to be switched on.
- Example:** Mode: *only range*
 Threshold B = 100
 Reference value = 100 with value **rising**, Status **A-B** = ON
 Reference value = 100 with value **falling**, Status **B-C** = ON

Output variables Mode <i>Ranges</i>	
Status < A	Status ON if the reference value is less than threshold A
Status A-B Status x-xx	Status ON if the selected mode applies x = threshold one level below the highest threshold defined xx = highest threshold defined
Status > xx	Status ON if the reference value is greater than threshold xx (= highest threshold defined)
<ul style="list-style-type: none"> The threshold values should be defined in ascending order starting from threshold A. If the threshold has a value that is equal to or less than preceding thresholds, then the modes only range, Ranges >= value and Ranges > value will ignore and skip all preceding thresholds. <p>Example: Threshold A = 0°C Threshold B = 10°C Threshold C = 20°C Threshold D = 0°C (i.e. lower than thresholds B and C) The reference value is >0 °C, for example 8 °C or 15 °C. In that case, only the status >D will be switched to ON in those modes, as the value is above threshold D.</p>	

Input variables Mode <i>Binary decoder</i>	
Enable	General enabling of the function (digital value ON/OFF)
Reference value	Analogue input signal for the reference value to be decoded
Threshold A - (max.) J	Selection of the required thresholds
<ul style="list-style-type: none"> Reference value: For decoding, the total numerical value is used without a decimal point (e.g. 25.4 °C -> the value 254 is decoded -> 11111110). The thresholds specify the bits to be evaluated (0 = bit 0, 1 = bit 1, etc.) 	

Parameters Mode <i>Binary decoder</i>	
Mode	Selection: <i>Binary decoder</i>
No. of thresholds	Enter the number of thresholds, up to 10

Output variables Mode <i>Binary decoder</i>	
Status < A	Status always OFF
Status A-B Status B-C Status C-D	Status ON if bit on threshold A is 1 Status ON if bit on threshold B is 1 Status ON if bit on threshold C is 1 etc.

Shading function

Function description

The Shading function supplies the **defaults for the Blind control function** according to the type of blind, position of the sun, and building restrictions.

You can switch between automatic mode and manual mode.

In the parameter settings, you must enter precise details about the blinds, the cardinal direction of the windows, and restrictions imposed by building characteristics.

For the Shading function to work correctly, the specifications entered in the Date / time / location area must be correct (GPS data for geographical latitude and longitude).

Input variables

Enable	General enabling of the function (digital value ON/OFF)
Enable auto mode	Digital input signal, ON/OFF
Open	Digital input signal, ON/OFF
Close	Digital input signal, ON/OFF
Set horizontally	Digital input signal, ON/OFF
Maximum shading height	Analogue value or analogue input signal as a percentage (to one decimal place)

- If Enable **auto mode** is set to **OFF**, then only **manual** operation is possible, using the input variables Open, Close and Set horizontally
- If the input variables Open, Close or Set horizontally are set to **ON**, they will be **dominant** in effect and will **override** the auto mode.
If more than one of these three input variables is set to ON, the following order of priority applies:
Open (1), Close (2), Set horizontally (3)
- Closing or opening by means of a time program can be achieved by linking the status of the **Time switch** function to one of the input variables **Enable auto mode**, **Open** or **Close**.
- **Maximum shading height**: Limits the height of the blind or shutter (100 % = all the way down, 0 % = all the way up); only applies in auto mode. In manual mode, the maximum shading height is **ignored**.

Parameters	
Slats	Blinds: enter Yes Roller shutters: enter No
Width (shown only if slats: Yes)	Enter the slat width in mm (see Figure 1)
Clearance (shown only if slats: Yes)	Enter the distance between slats in mm (see Figure 1)
Slats horizontal at	Enter the percentage for horizontal slat position
Window settings	
Cardinal direction	Enter the cardinal direction of the window (see Figure 2): North = 0° East = 90° South = 180° West = 270°
Diff. on	Correction of the start time due to building characteristics (see Figure 2)
Diff. off	Correction of the stop time due to building characteristics (see Figure 2)
Solar altitude correction	Option for manual correction of the slat position
Minimum solar altitude	If the sun is below the minimum solar altitude, the function will act according to the if max. solar altitude switching condition (see Figure 3)
Maximum solar altitude	If the sun is above the maximum solar altitude, the function will act according to the if max. solar altitude switching condition (see Figure 3)
Shading settings	
Interval time	Enter the minimum time interval between two changes of slat position
Switching conditions	
if enable = off	Action of the function if enable = OFF
if enable auto mode = off	Action of the function if enable auto mode = OFF
if shading area end	Action of the function if the sun moves out of the shading area
if max. solar altitude	Action of the function if the sun stands above the maximum solar altitude or below the minimum solar altitude
<ul style="list-style-type: none"> • If "Slats: No" is set (= roller shutter), only the upward/downward movement will be regulated, not the slat positioning. • Switching conditions: These parameters define the output signal for blind control of the respective function states. Available for selection: Open, Close, Unchanged, set horizontally 	

• **Figure 1:** Slat dimensions

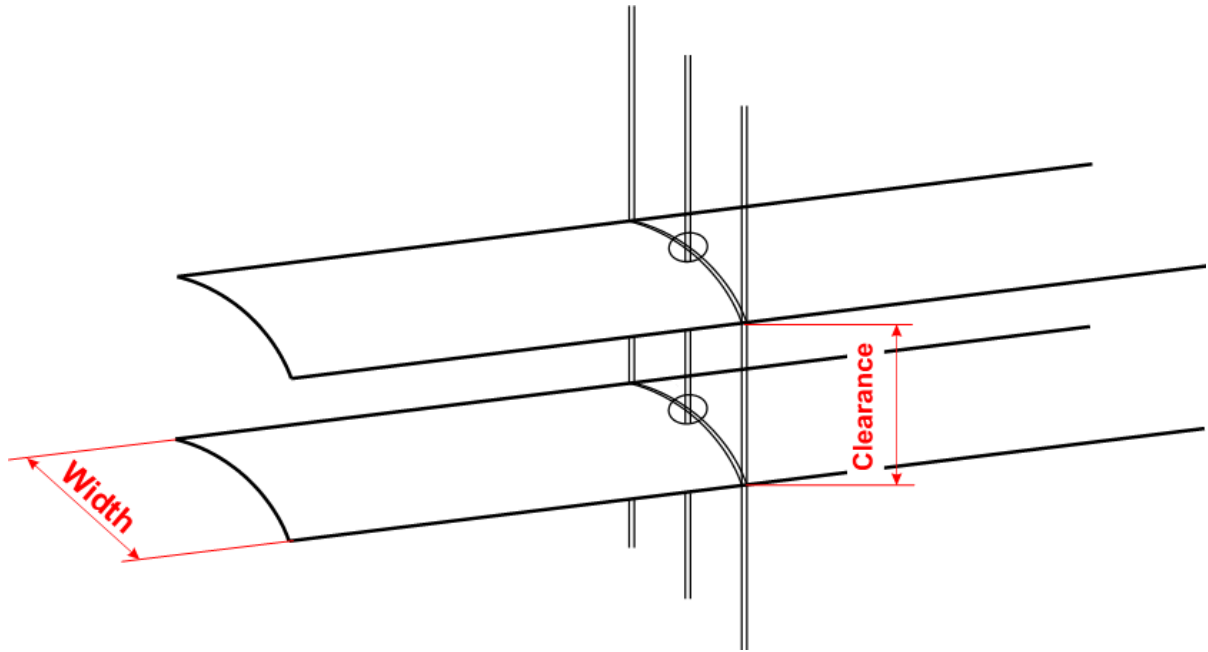

• **Figure 2:** Cardinal direction, Diff. on, Diff. off (view: plan)

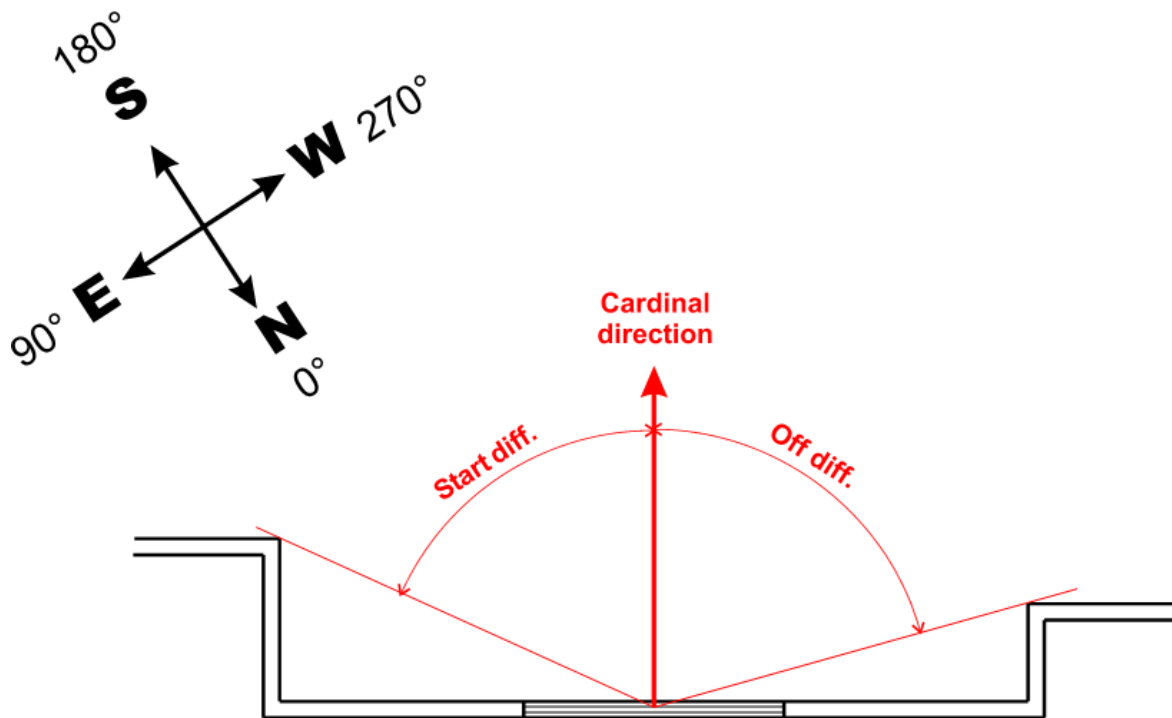

• **Figure 3:** Maximum and minimum solar altitude (view: elevation)

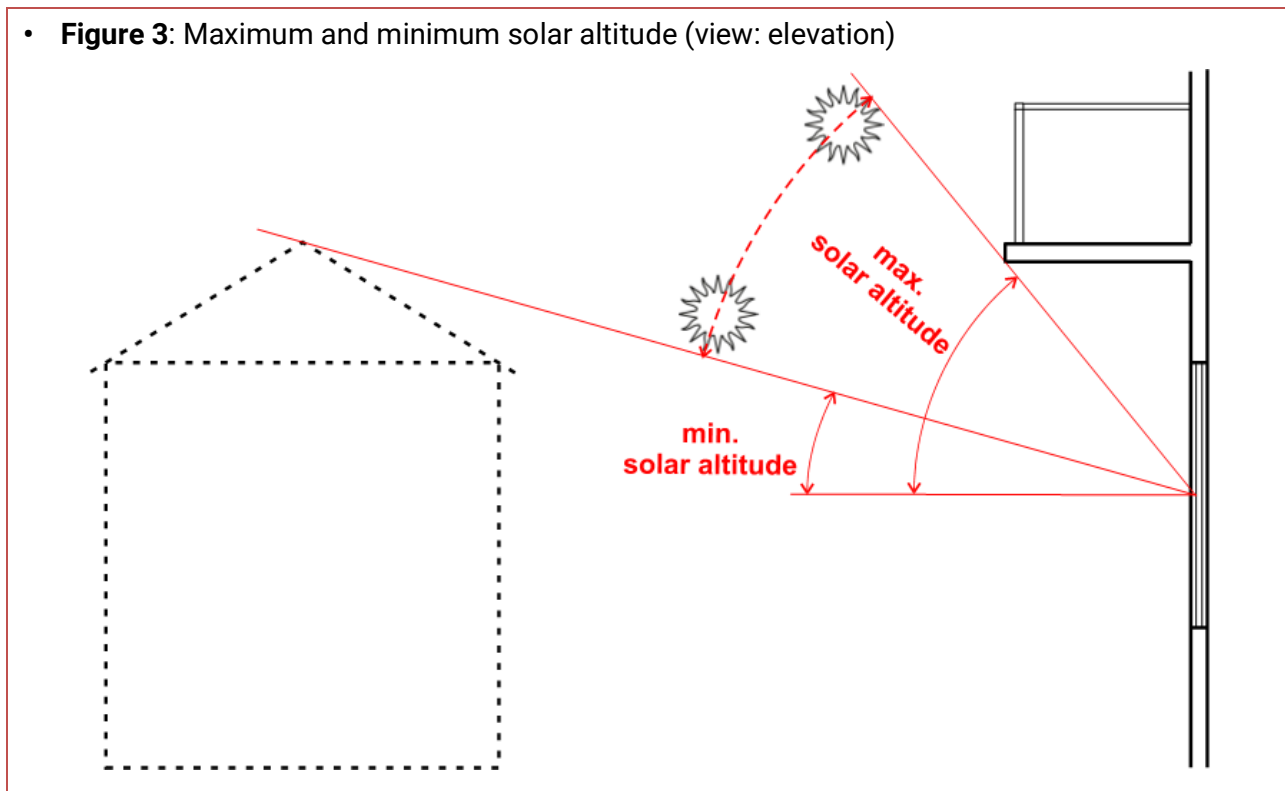

Output variables

Auto mode set position	Two percentages are included in this output: 1st percentage: slat position, 0 % = horizontal , 100 % = vertical 2nd percentage: 0 % = blind or shutter all the way up , 100 % = all the way down
Auto mode status	Status ON if in auto mode Status OFF if manual shading has been started or if enable or enable auto mode is OFF.
In the shading area	Status OFF if the sun is outside the range Diff. on – Diff. off, if manual shading has been started or if enable is OFF.
Interval timer	Display of a countdown of the interval time



- If "**Roller shutter**" is set (parameter "Slats: **No**"), the **first** percentage of the auto mode set position and the slat set position is always **0** %.

Individual room control

Function description

This function is specially designed for the control of zone valves for heating and/or cooling of individual rooms. Room temperature thresholds or the operating mode switch on the room sensor can be utilised to switch between heating and cooling. Shutdown conditions prevent heating or cooling beyond outside temperature thresholds.

Eingangsvariablen

Enable	General enabling of the function (digital value ON/OFF)
Enable heating	This enable can be used to block heating mode (digital value, ON/OFF).
Enable cooling	This enable can be used to block cooling mode (digital value, ON/OFF).
Room temperature	Analogue input signal for the room temperature
Outside temperature	Optional: Analogue input signal for the outside temperature
Floor temperature	Optional: Analogue input signal for the floor temperature
Time condition status	Digital input signal, ON/OFF (e.g. from the Time switch function)
Set room temperature	Analogue value specifying the set room temperature
Set floor temperature	Analogue value specifying the set floor temperature (only if a floor temperature sensor is defined)
Offset set room temp	Optional: Analogue value specifying an offset for the set room temperature
Window contact	Digital input signal, ON/OFF
<ul style="list-style-type: none"> • If the outside temperature sensor is also linked to this function, the heating and/or cooling mode can be blocked by means of shutdown conditions. • The Time condition status will switch off both heating mode and cooling mode outside the time window. Therefore if time conditions are not required, the Time condition status must be changed to <i>User</i> and set to ON. • The frost protection function remains active when Time condition status is OFF. • An OFF signal at the Window contact input variable will switch off heating mode and cooling mode, or will switch the system to frost protection mode. The system will switch to frost protection mode if the room temperature is below the T.room frost parameter value. • If a RASPT, RAS-PLUS or RAS-F room sensor is used, the operating mode for the function can be set using the operating mode switch: <ul style="list-style-type: none">  AUTO: The system switches automatically between heating and cooling according to the settings.  STANDARD: Only heating mode is allowed.  SETBACK: Only cooling mode is allowed (frost protection remains active). 	

Parameters	
Room temperature Set temperature	Display of the set room temperature + Offset value defaulted by the input variable
Heating diff. on Heating diff. off	Start differential for the set room temperature in heating mode. Stop differential for the set room temperature in heating mode.
Cooling diff. on Cooling diff. off	Start differential for the set room temperature in cooling mode Stop differential for the set room temperature in cooling mode
Floor temperature Set temperature (shown only if a floor sensor is defined)	Display of the set floor temperature defaulted by the input variable (for more information: see chapter Floor temperature)
Floor min. diff. on Floor min. diff. off	Start differential for the minimum set floor temperature Stop differential for the minimum set floor temperature
Floor max. diff. on Floor max. diff. off	Start differential for the maximum set floor temperature Stop differential for the maximum set floor temperature
Delay Cooling -> heating Heating -> cooling	Adjustable changeover delay when changing from cooling mode to heating mode, or from heating mode to cooling mode.
Average	Sub-menu: Calculation of an adjusted outside temperature, which will be utilised for the shutdown conditions (see Average sub-chapter)
Shutdown conditions	Sub-menu: Shutdown conditions utilising the outside temperature, for both heating mode and cooling mode (see Shutdown conditions sub-chapter).
T.room frost	If the room temperature falls below T.room frost, this temperature is applied as the set room temperature for heating operation (frost protection mode with fixed hysteresis of 2 K).
<ul style="list-style-type: none"> • Room temperature: The differential value Diff. off for heating cannot be greater than Diff. on for cooling. Similarly, the differential value Diff. on for cooling cannot be less than Diff. off for heating. • Floor temperature: Floor min. Diff. on cannot be greater than floor min. Diff. off. Likewise, floor max. Diff. on cannot be greater than floor max. Diff. off. 	

FLOOR TEMPERATURE

The parameters for the floor temperature limit the floor temperature by means of maximum and minimum thresholds. These thresholds interact with the set room temperature differently in heating mode and cooling mode.

Heating mode

If the floor temperature **falls below** the minimum threshold **min. Diff. on**, heating mode will be activated and cooling mode blocked regardless of the room temperature until the floor temperature exceeds the threshold **min. Diff. off** (logical OR operation with the set room temperature for heating).

If the floor temperature **exceeds** the maximum threshold **max. Diff. off**, heating mode will be blocked and cooling mode activated regardless of the room temperature until the floor temperature falls below the threshold **max. Diff. on** (logical AND operation with the set room temperature for heating).

Cooling mode

If the floor temperature **falls below** the minimum threshold **min. Diff. on**, cooling mode will be blocked and heating mode activated regardless of the room temperature until the floor temperature exceeds the threshold **min. Diff. off** (logical AND operation with the set room temperature for cooling).

If the floor temperature **exceeds** the maximum threshold **max. Diff. off**, cooling mode will be activated and heating mode blocked regardless of the room temperature until the floor temperature falls below the threshold **max. Diff. on** (logical OR operation with the set room temperature for cooling).

N.B.: For cooling mode, the effective meaning of the terms **Diff. on** and **Diff. off** is the opposite of their apparent meaning.

Parameters in the Average sub-menu

When outside temperatures form the basis of the shutdown conditions, fluctuations in those temperatures can sometimes be undesirable. The option of adjusting the outside temperature is therefore available for the purposes of shutdown. The following entries are found in this sub-menu:

For shutdown	Calculation of the adjusted outside temperature
Aver. time	Entry for the averaging time
Average	Result of the calculation

Parameters in Shutdown conditions sub-menu

Shown only if the outside temperature sensor is defined.

if T.outside	Heating shuts down if the adjusted outside temperature in heating mode exceeds a threshold value.
Aver.off > max heating	Required threshold value for the outside temperature
T.outside max heating	Start differential for T.outside max heating
Diff. on	Stop differential for T.outside max heating
Diff. off	
Aver.off < min. cooling	Cooling shuts down if the adjusted outside temperature in cooling mode falls below a threshold value.
T.outside min cooling	Required threshold value for the outside temperature
Diff. on	Start differential for T.outside min cooling
Diff. off	Stop differential for T.outside min cooling

Output variables	
Effective set room temp.	The effective (=current) set temperature as defaulted by the input variable + Offset value or by frost protection mode.
Heating	Status ON if heating mode is active
Cooling	Status ON if cooling mode is active
Open valve	Status ON if heating or cooling mode is active
Close valve	Status ON if neither heating nor cooling mode is active
Frost protection mode	Status ON if the room temperature is below T.room frost
T.room < T.room set (heating)	Status ON if the actual room temperature is lower than the set room temperature + Offset value + Diff.
T.room > T.room set (cooling)	Status ON if the actual room temperature is higher than the set room temperature + Offset value + Diff.
T.floor < set max. (heating)	Status ON if the actual floor temperature is lower than the set floor temperature + Floor max. Diff.
T.floor < set min. (heating)	Status ON if the actual floor temperature is lower than the set floor temperature + Floor min. Diff.
T.floor > set max. (cooling)	Status ON if the actual floor temperature is higher than the set floor temperature + Floor max. Diff.
T.floor > set min. (cooling)	Status ON if the actual floor temperature is higher than the set floor temperature + Floor min. Diff.
Aver.off < max. heating	Status ON if the condition is met (including + Diff.).
Aver.off > min. cooling	Status ON if the condition is met (including + Diff.).
Aver. OT for shutdown	The adjusted outside temperature
Heating delay	Display of a countdown of the delay for changeover to heating mode
Cooling delay	Display of a countdown of the delay for changeover to cooling mode
<ul style="list-style-type: none"> • There are different output variables for Heating, Cooling, Open valve and Close valve. Which ones are used depends on the hydraulic conditions of the system. • If enable = Off, all statuses are set to OFF. • If enable heating = Off, the frost protection function is deactivated as well. 	

Energy manager

Function description

The energy manager manages up to 12 output control functions. The (usually) available surplus output measured and calculated by the CAN-EZ3 is divided between the **output controls** involved due to various parameters and user defined priorities.

Input variables

Enable	General enabling of the function (digital value ON/OFF)
Power from grid	Power currently being drawn from the grid <ul style="list-style-type: none"> Negative when power is being exported to the grid Positive when power is being drawn from the grid
Set value	Set value for power drawn from the grid

- The **Power from grid** input variable is best linked to the **system value** "Total active power" of the energy meter used.
- The set value (factory setting: -500 W) makes it possible to prevent power being drawn from the grid for brief periods (= tolerance value).
Without this kind of tolerance value, a set output level may be specified for the consumer that cannot be generated by the system (any longer), with the result that power is briefly drawn from the grid to meet the set output level. By specifying a negative value, power is exported to the grid instead.

Parameters

No. of involved functions	No. of involved output control functions
Involved functions	Click once and then you can specify the involved output control functions.
Priority	Priorities can be assigned here to the output control functions that are set as involved. When surplus power is available, it is first used by the output control with priority 1 (= highest priority). The function with the next highest priority does not become active until the first function's max. consumer output is reached.

- It is not necessary to establish a link to the output control functions. Instead, the **Involved functions** parameter is used.

Output variables

Residual power	Amount of available power not used
Power used	Amount of available power used

- These output variables are only used for display purposes, e.g. in a function overview. The consumers are linked to the output variables of the involved output control functions.

Example of a standard diagram

Energy manager with output control
CAN-EZ3 and EHS(-R)

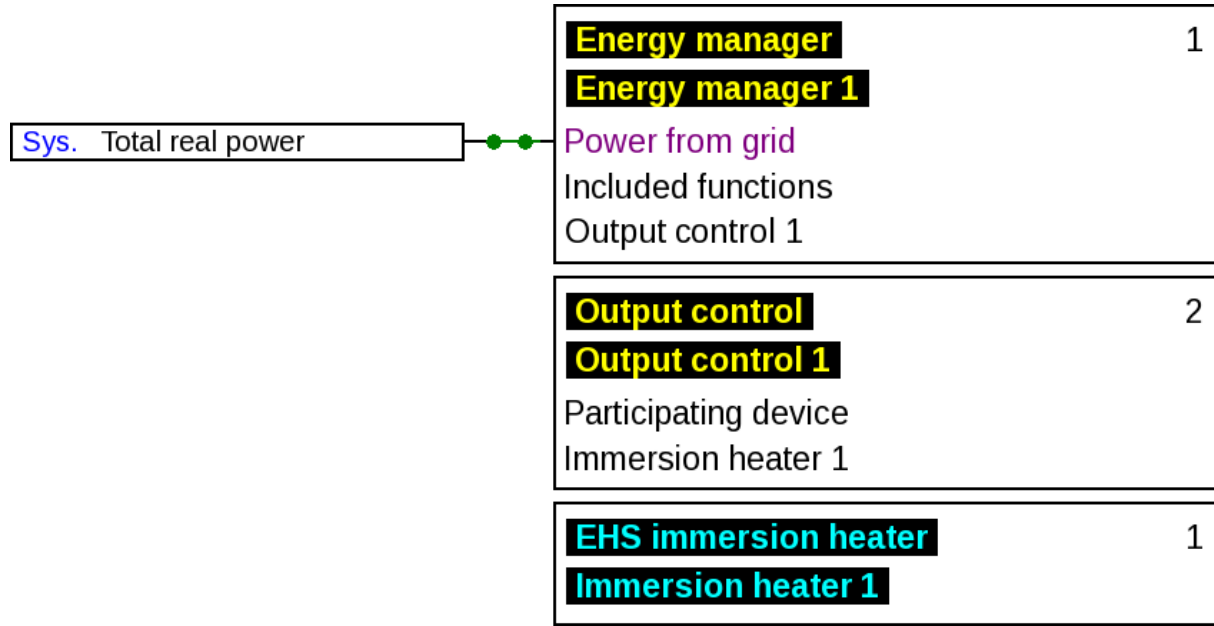

Energy meter

Function description

The energy meter takes the **analogue** value for **energy output** from other sources (e.g. CAN energy meter CAN-EZ) and meters the energy according to that value.

Input variables

Enable	General enabling of the function (digital value ON/OFF)
Output	Analogue value specifying the energy output in kW (to two decimal places)
Meter reset	Digital input signal, ON/OFF, to reset the meter
Price / unit	Input of a price per unit (1 kWh)

- When the energy output value is adopted, note that two decimal places must be included. **Example:** A dimensionless number 413 will be adopted as 4.13 kW.
- If the energy output values are negative, note that the metering will be negative as well, i.e. the metered values can also become negative.
- The **meter reset** is carried out by means of a digital ON pulse or manually from the parameter menu. It will delete **all** meter readings, in other words also those from previous periods.
- When the **Price / unit** is transferred from a source, note that five decimal places must be included. **Example:** A dimensionless number without a decimal point such as 413 will be adopted as 0.00413. If the source is a **Fixed value**, the unit used should not be a currency (Euro or Dollar) but rather **Dimensionless (.5)**.

Parameters

Factor	Optional: enter an integral factor (a whole number) for the multiplication of the input value
Delete meter reading	Pressing this button opens a confirmation prompt, followed by a reset of all meter readings, including those from previous periods.

Output variables	
Output	The energy output, with the factor applied
Day meter reading	
Prev. day meter reading	
Week meter reading	
Prev. week meter reading	
Month meter reading	
Prev. month meter reading	
Year meter reading	
Prev. year meter reading	
Kilowatt hours total	
Day sum	
Previous day sum	
Week sum	
Prev. week sum	
Month sum	
Prev. month sum	
Year sum	
Prev. year sum	
Sum total	
<ul style="list-style-type: none"> • PLEASE NOTE: The meter readings from the Energy meter function module are saved to the internal memory every hour. Therefore, in the event of a power failure, no more than 1 hour of metering can be lost. • When loading function data, you will be prompted whether you want to apply the saved meter readings (see the Programming Part 1: General information manual). • The changeover of the Week meter occurs on Sundays at 24:00 h. • The meter readings can also be deleted manually in the parameter menu. 	

Gradient detection

Function description

This function offers a choice of two different modes:

Slope detection uses various methods to detect the **direction** of a change in a value and indicates that direction in the output variables. The minimum and maximum values are determined simultaneously.

Gradient detection compares the **speed** of a value change with a predefined value (e.g. 5 K/min).

Definitions:

Gradient: Rate of **change** in a parameter (e.g. temperature) between defined points in time (or space). The direction of the change may be positive or negative.

Quasi peak: A peak value (minimum or maximum) is weighted by a time constant (K/min) and thus changes continuously (also called quasi peak value).

Input variables

Enable	General enabling of the function (digital value ON/OFF)
Signal	Analogue input signal from the sensor being monitored
Reset	Digital input signal, ON/OFF, to start slope or gradient detection (pulse)
Differential	Analogue value or analogue input signal specifying the activation differential for slope detection or specifying the value change of the gradient for gradient detection (see function description and graphs)
<ul style="list-style-type: none"> • If a digital signal is connected to the Reset input variable, the corresponding Status and Value output variables will be issued for the first data capture after the end of the reset pulse and will be retained until the next reset. • If Reset is set to unused, then the Status and Value for slope detection will be recalculated at every positive or negative slope, subject to mode. In the case of gradient detection, the temperature curve is observed continuously. 	

Parameters for slope detection

Function quantity	A wide range of function quantities are available, which are applied together with their unit and their decimal places.
Mode	Available for selection: <i>Slope detection</i>
Slope	Available for selection: <i>positive</i> or <i>negative</i>
Quasi Peak	Available for selection Yes / No (for detailed information: see function description and graphs)
Value (shown only if Quasi peak Yes)	Specifies the gradient for the quasi peak in units/minute, e.g. entering 5.0 K means 5.0 K/min .
<ul style="list-style-type: none"> • Slope: According to <i>positive</i> or <i>negative</i> selection, the function will detect either a rising (<i>positive</i>) or falling (<i>negative</i>) slope of the curve. • Differential input variable: Slope detection is not activated until the capture from the monitored sensor reaches the differential for minimum (positive slope) or maximum (negative slope). • The following graphs refer to the Temperature function quantity, but can be applied to any other function quantity as well. 	

Graph for slope detection / positive slope/ no reset signal / no quasi peak

Enable ON

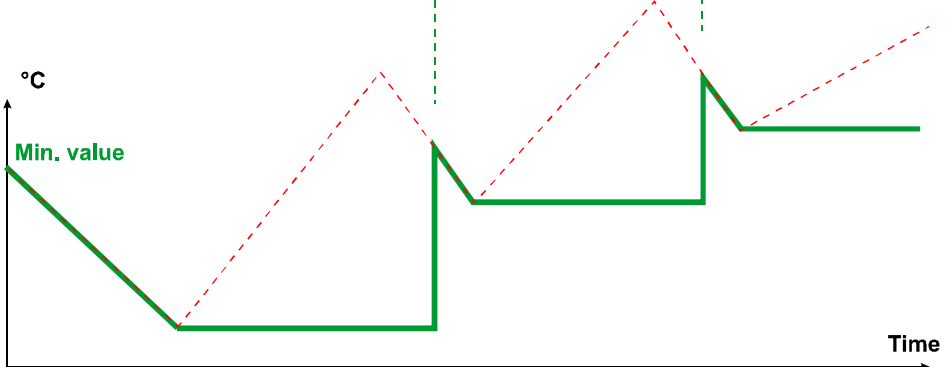
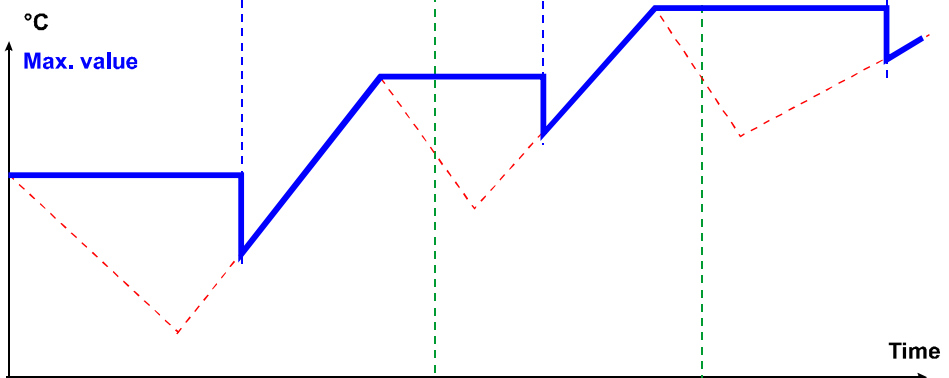
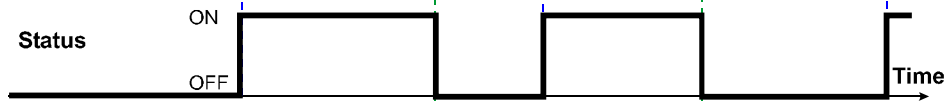
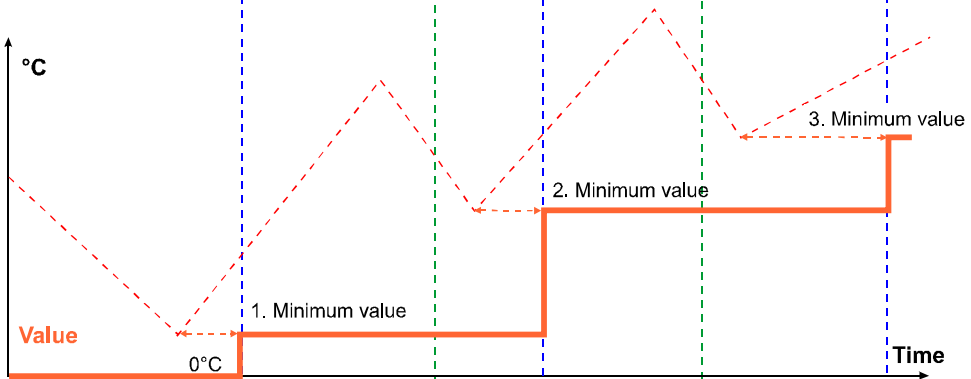
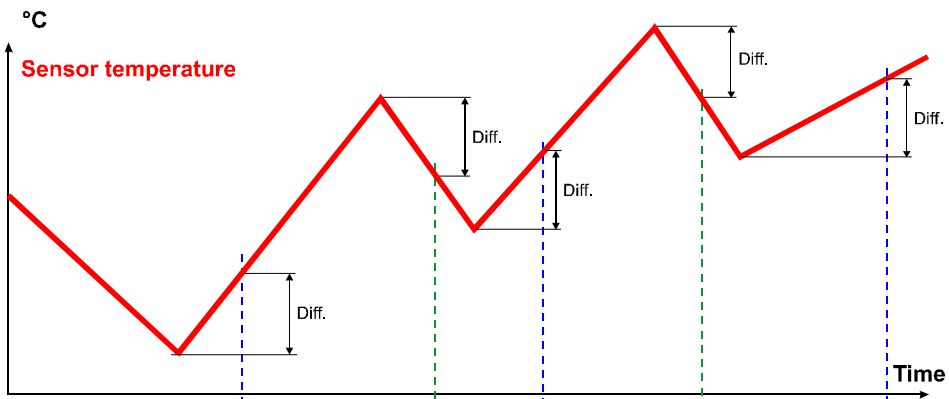

Graph for slope detection / positive slop / reset signal / no quasi peak

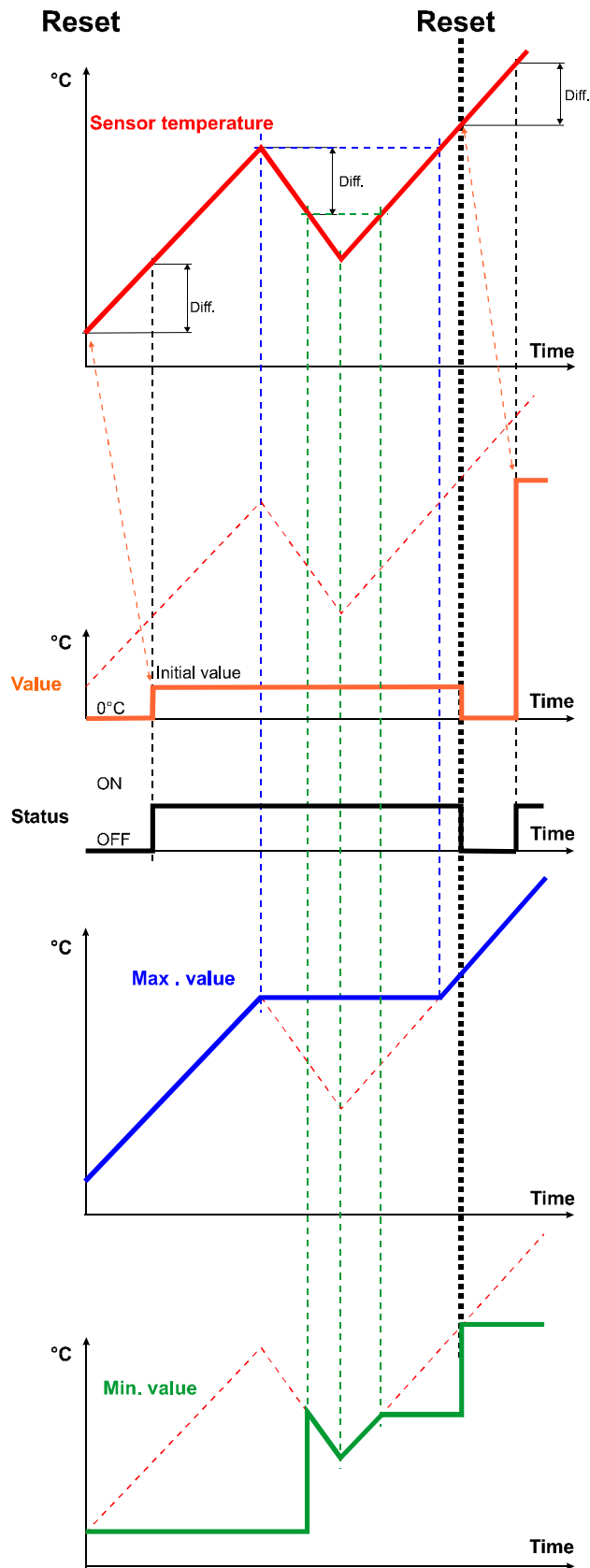

Graph for slope detection / negative slope / no reset signal / no quasi peak

Enable ON

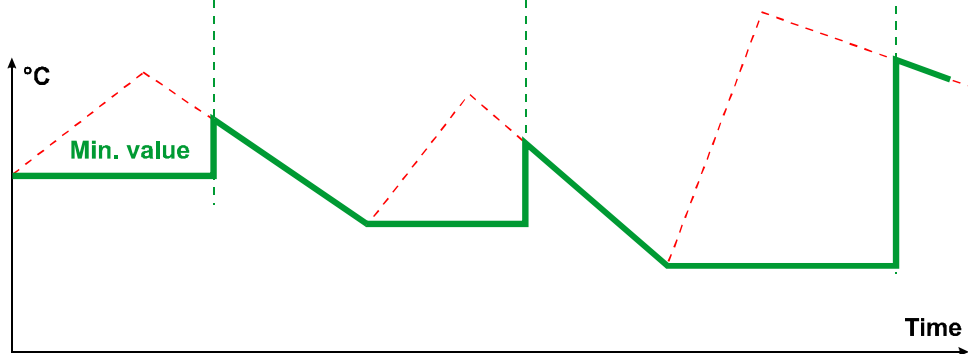
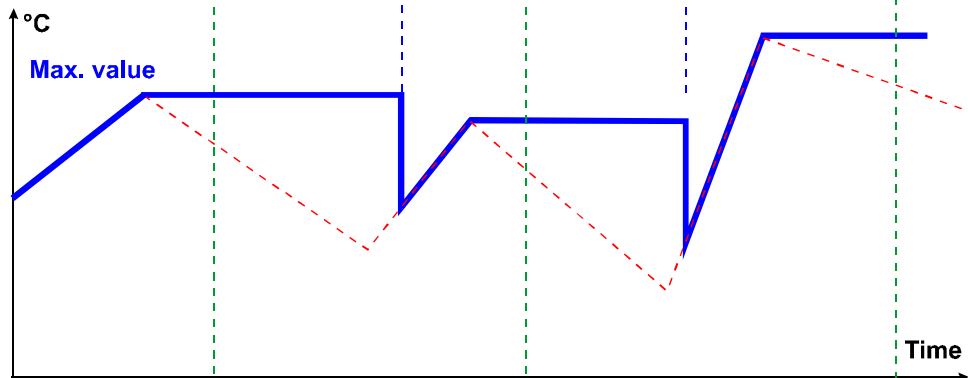
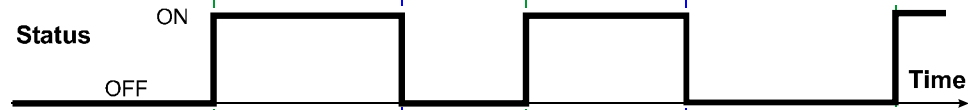
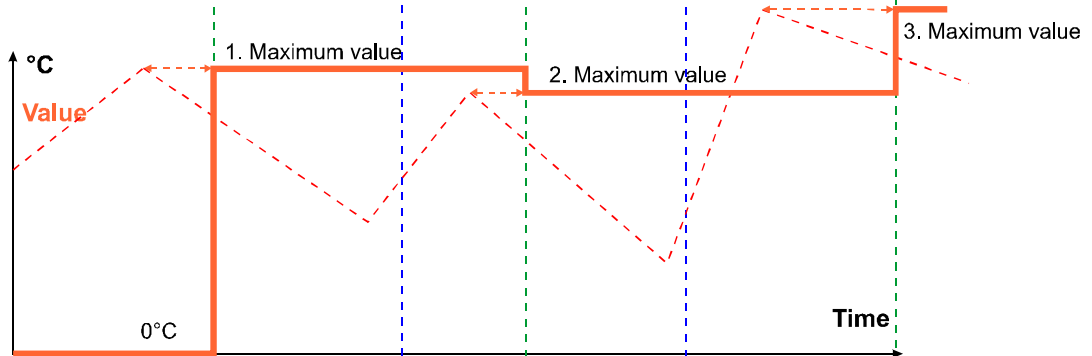
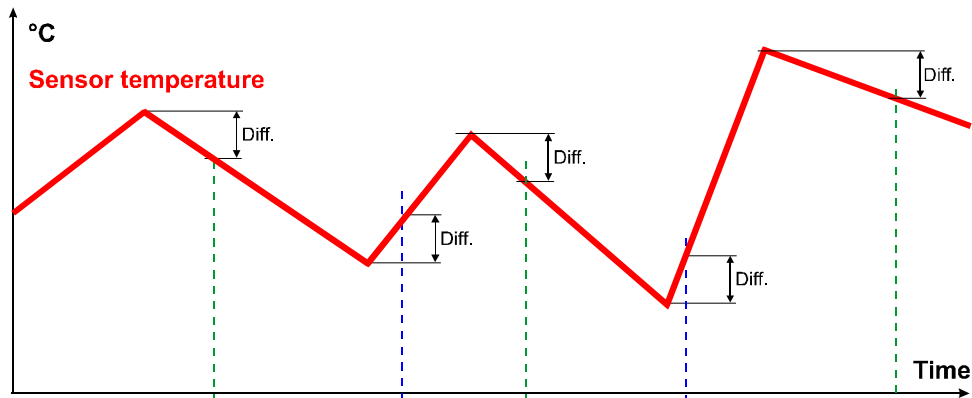

Graph for slope detection / positive slope / no reset signal / quasi peak

Enable ON

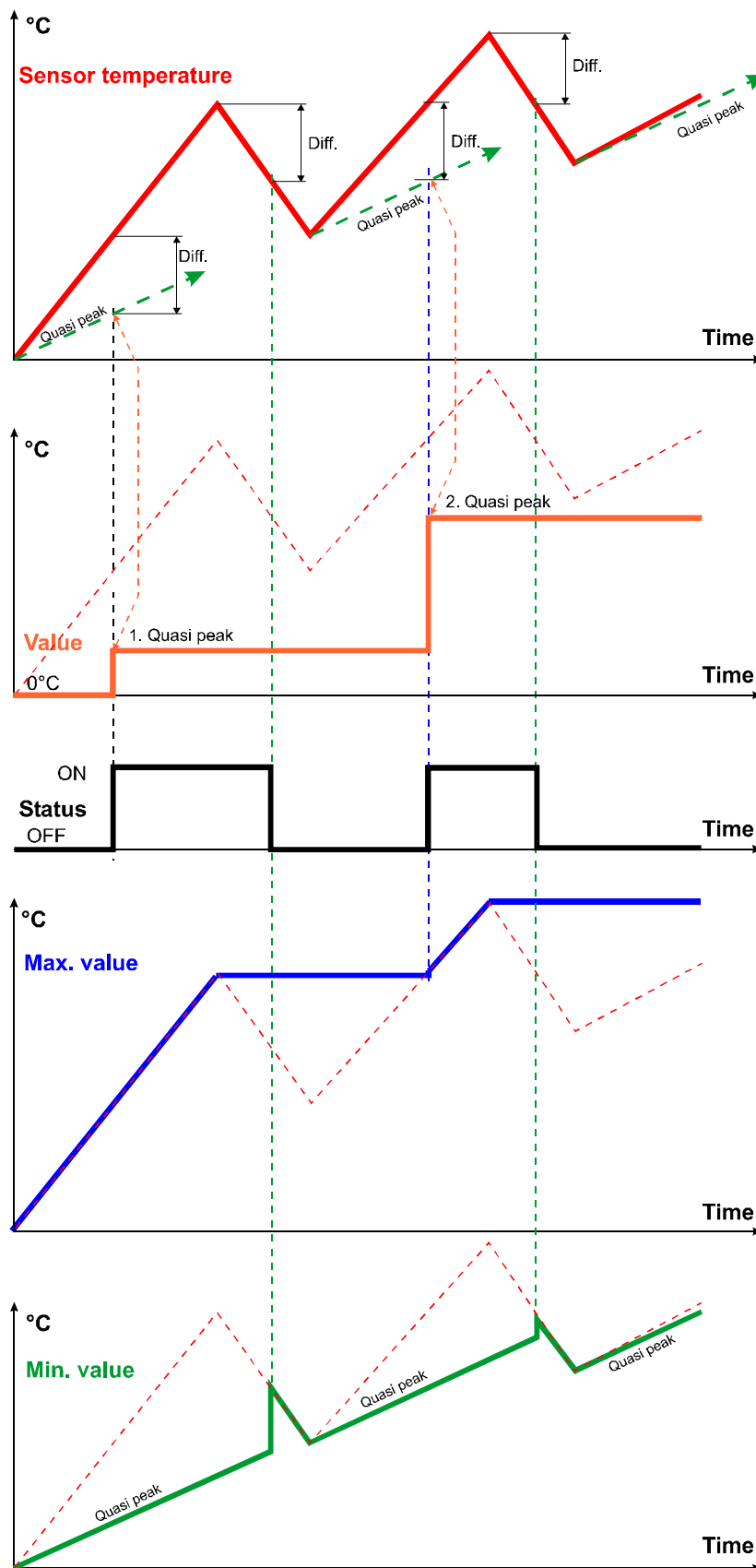

Graphs for slope detection / positive slope / no reset signal / quasi peak
Additional example

Temperature rising slowly at first; the differential for minimum + quasi peak is not reached up to the first maximum. The differential is only exceeded when the temperature rises more steeply later. At that point, the Status output switches to ON and the Value output variable indicates the quasi peak temperature.

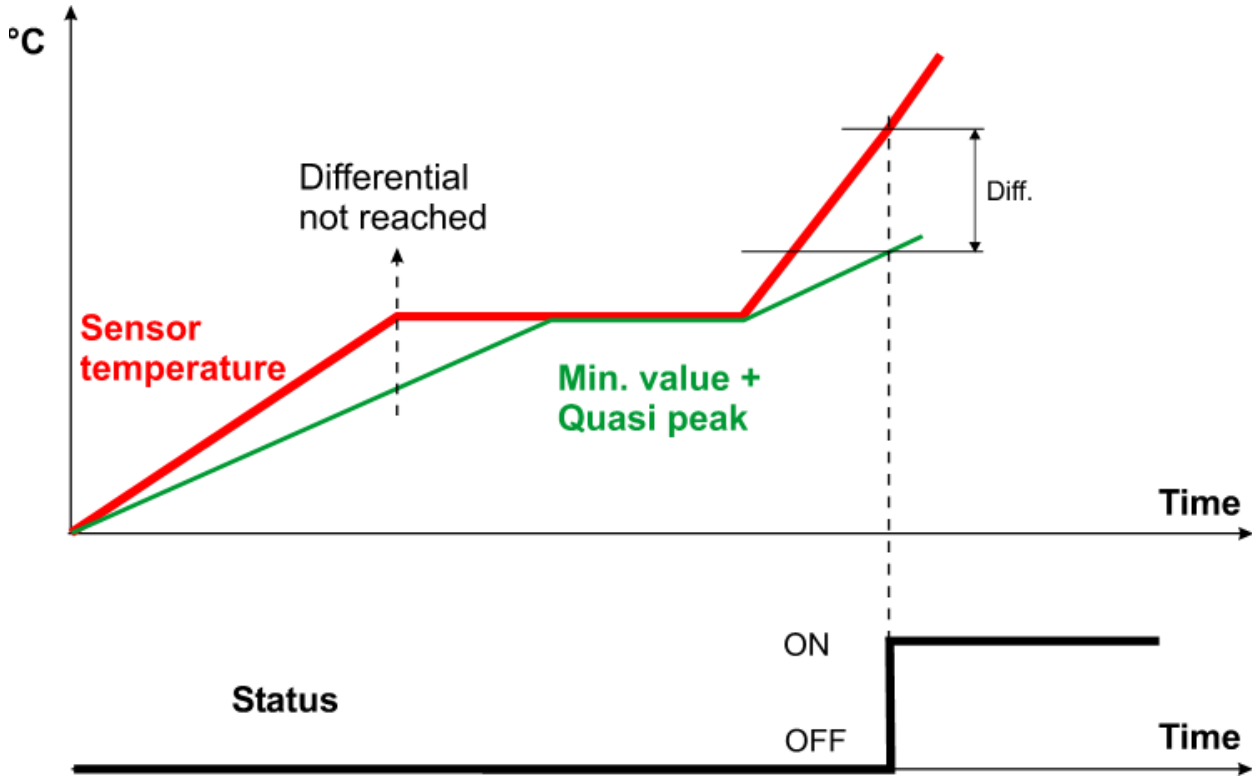

Example: Temperature falling at first, then rise in temperature

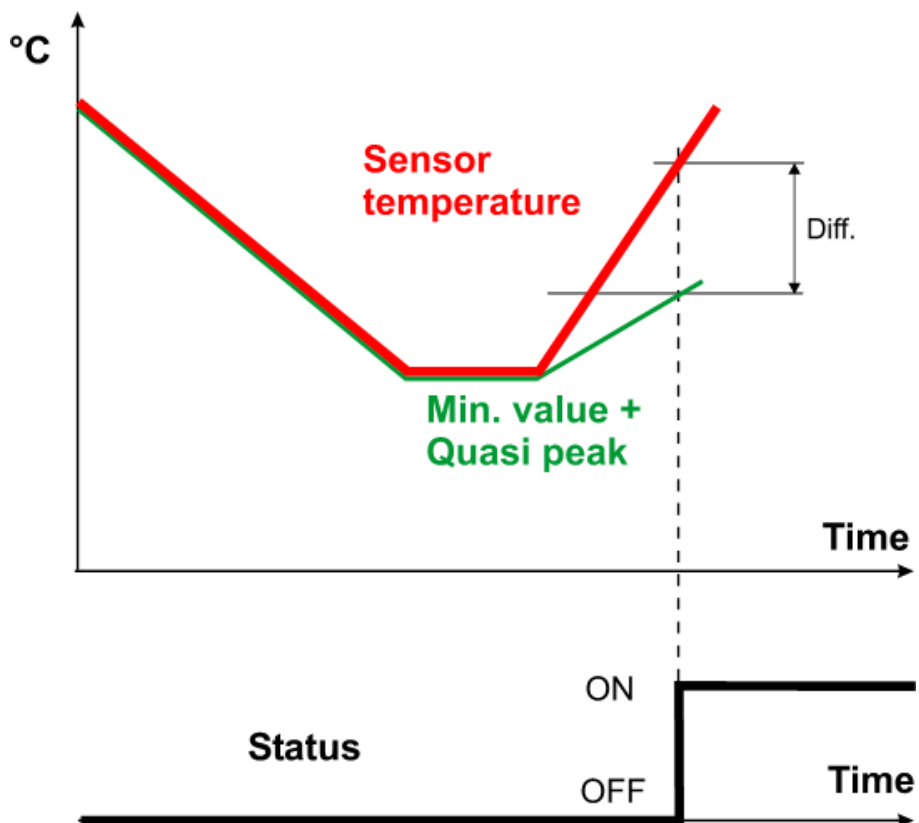

Graph for slope detection / negative slope / no reset signal / quasi peak

Enable ON

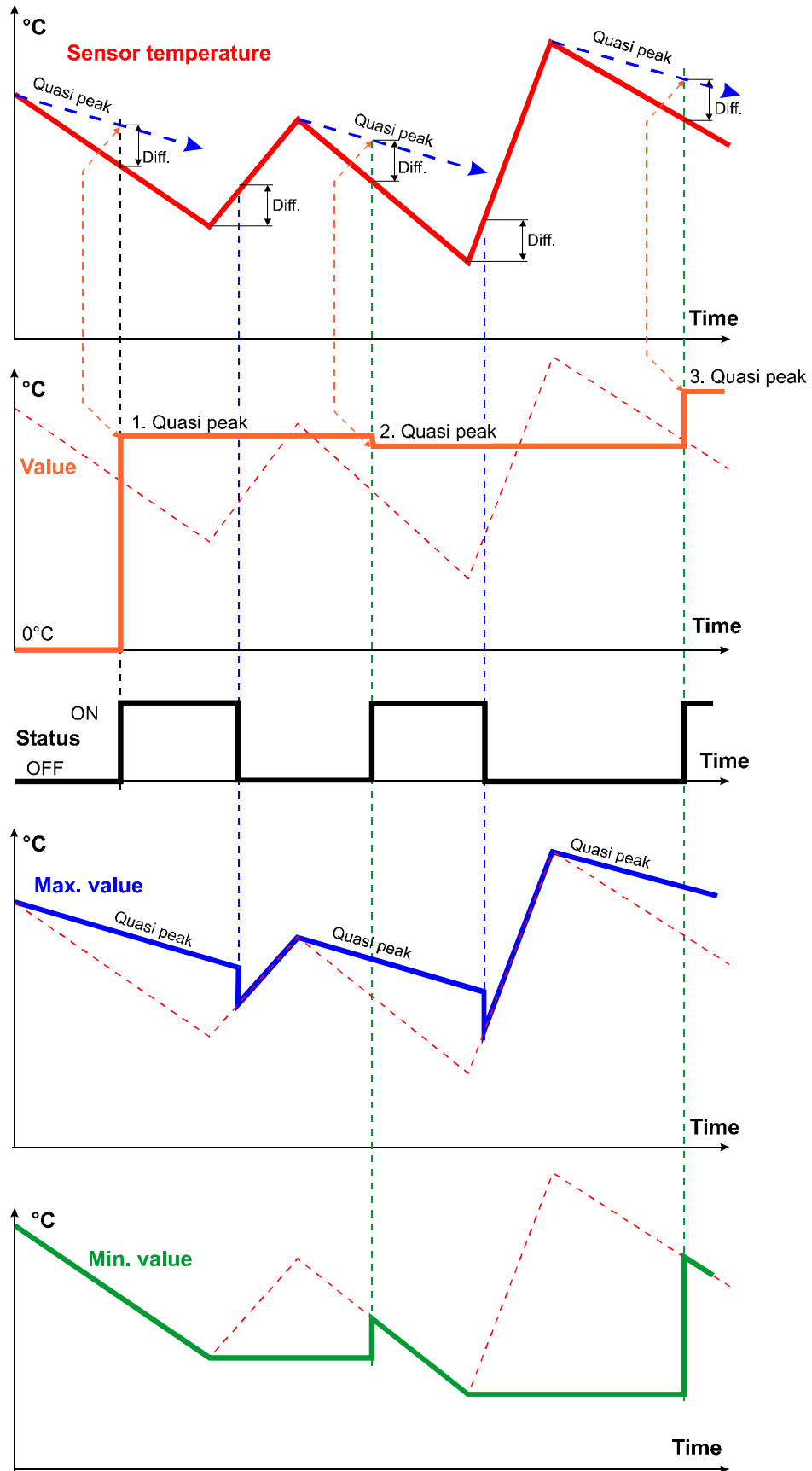

Parameters for gradient detection

Function quantity	A wide range of function quantities are available, which are applied together with their unit and their decimal places.
Mode	Available for selection: Gradient detection
Gradient	Specifies the required gradient as value change/time unit. The value change is defined by the Differential input variable. If a negative value is entered for the value change, a falling gradient will be detected.

Graph for gradient detection

Positive gradient

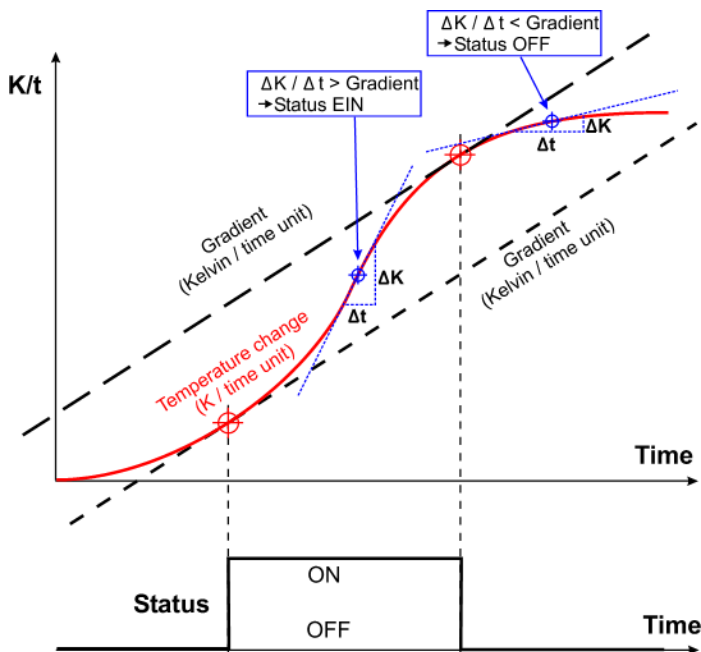

The status switches to ON if the rise in temperature **within a tenth** of the set **time unit** is greater than the set gradient.

The "**Differential**" setting in the input variables should not be less than 2.0 K, otherwise test value fluctuations could lead to a false result.

Example:

If the selected gradient is 5.0 K/20 seconds, the controller checks every 2 seconds whether the temperature has risen more than 0.5 K.

Negative gradient

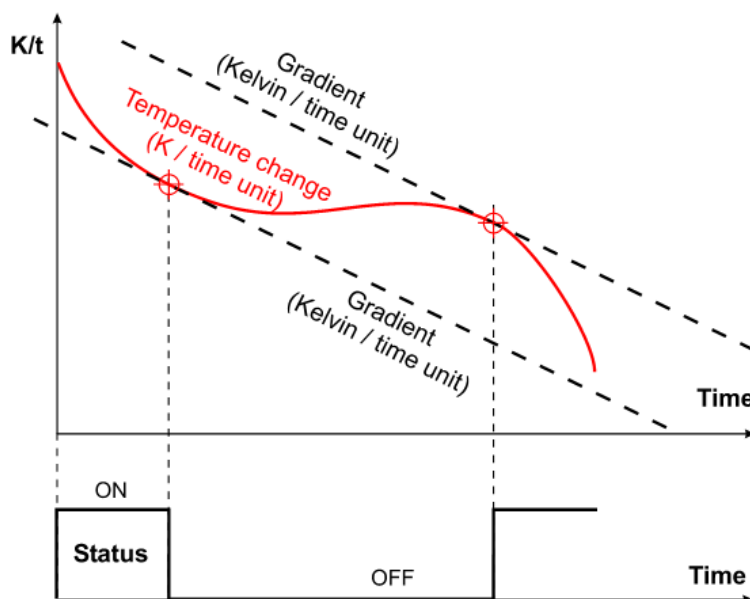

The Status switches to ON at the point where the curve of the **Temperature change** becomes steeper than the gradient.

Output variables	
Value	<p>Slope detection: Sensor value when the differential for positive (rising) or negative (falling) slope is reached</p> <p>Gradient detection: display is always 0</p>
Status	<p>Slope detection: Status is ON when the differential for positive (rising) or negative (falling) slope is reached (= slope detected). Status is OFF when the differential is reached again after a maximum (positive slope) or minimum (negative slope) (see graphs).</p> <p>Gradient detection: Status is ON when the set gradient is exceeded (see graphs)</p>
Max value	<p>Slope detection: The maximum value determined according to mode</p> <p>Gradient detection: display is always 0</p>
Min value	<p>Slope detection: The minimum value determined according to mode</p> <p>Gradient detection: display is always 0</p>
<ul style="list-style-type: none"> • Value: The way sensor values are calculated varies depending on the mode selected (see the corresponding graphs) • Slope detection for positive slope with quasi peak: The Min. value rises with the set value of the quasi peak as soon as there is a trend reversal in the minimum. It never exceeds the Max. value, however. • Slope detection for negative slope with quasi peak: The Max. value falls with the set value of the quasi peak as soon as there is a trend reversal in the maximum. It never falls below the Min. value, however. • With Reset signal in the input variables: The corresponding output variables Status and Value are only issued for the first data capture after the reset and remain frozen until the next reset. When reset, Value is set to 0 and Status is set to OFF. • Gradient detection: The display values for Value, Max. value and Min. value are issued as 0; only Status changes as data is evaluated. • If Enable = Off, all values are set to 0 and Status is set to OFF. 	

Heating circuit control

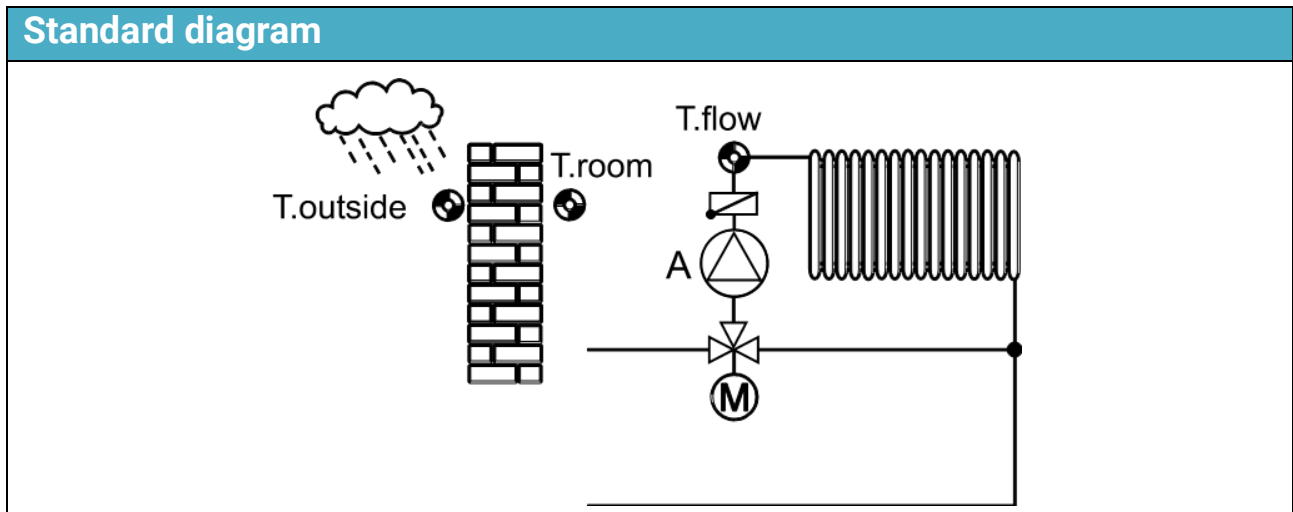

Function description

Mixer control for a heating circuit based on the outside and room temperature, subject to the heating and setback temperatures specified via the switching times. The heating circuit pump can be switched on and off via parameters, and changes in operating mode can be triggered by various input variables.

Input variables

Enable	General enabling of the function (digital value ON/OFF)
Enable pump	Enabling the heating circuit pump (digital value ON/OFF)
Enable mixer	Enabling the mixer (digital value ON/OFF)
DHW priority	Digital input signal, ON/OFF
Room temperature	Analogue input signal for the room temperature T.room
Flow temperature	Analogue input signal for the flow temperature T.flow
Outside temperature	Analogue input signal for the outside temperature T.outside
External switch	Digital input signal ON/OFF, or analogue input signal (see External switch sub-chapter) for operating mode changeover
Time condition status	Digital input signal, ON/OFF (e.g. from the Time switch function)
Set room temperature	Analogue value specifying a higher ranking set room temperature
Calendar op. mode	Input signal from the Calendar function for operating mode changeover (see sub-chapter and Calendar function)
Calendar set room t	Set room temperature when Calendar function is active (see sub-chapter and Calendar function)
Window contact	Digital input signal, ON/OFF (see Window contact sub-chapter)
Heating with ext set flow temp.	Digital input signal, ON/OFF
Ext. set flow temp.	User defined value or analogue input signal for the external set flow temperature
Offset set room temp	Analogue offset value for the set room temperature
Offset set flow temp.	Analogue offset value which is added to the calculated set flow temperature.

Input variables

- **Enable heating circuit = Off:** The entire heating circuit is deactivated (no frost protection!). The output variables for the set temperatures are set to 5 °C. All digital output variables are set to OFF, so the mixer remains unchanged as well.
The operating mode is set to Inactive (0). The operating level will not be changed, even if the operating mode or level is changed while Enable is OFF. The changed operating mode will only be applied when Enable is switched back to ON.
- **Enable pump = Off:** The pump stops, the mixer acts according to the setting in the shutdown conditions for Heating circuit pump = Off, and the output variables remain as they were with Enable pump ON (except for heating circuit pump and mixer). Frost protection remains active (see parameters menu for **Frost protection**).
- **Enable mixer = Off:** The mixer acts according to the setting in the shutdown conditions for mixer action when Enable mixer = Off. Frost protection remains active (see parameters menu for **Frost protection**).
- The **DHW priority ON** input signal switches the heating circuit pump **off** if the outside temperature is **above** the frost protection limit (unless the operating mode of the controller is a Special mode). The mixer acts according to the shutdown conditions for Heating circuit pump = Off; the output variables for operating mode, operating status and set temperatures are not changed. If the outside temperature is **below** the frost protection limit, this signal causes a dominant changeover of the heating circuit control to **Frost protection mode** (operating level Special mode) regardless of the current operating level.
- The **Time condition status** switches the heating circuit controller between standard mode and setback mode when the controller is working in the **Time/auto** operating mode. Standard mode applies with status ON, setback mode with status OFF.
- The **Set room temperature** input variable allows a value to be transferred to the heating circuit from another source (e.g. a time switch function). This value overwrites the internal settings "T.room setback" and "T.room standard" if internal operation is set to "**Time/auto**". If a room sensor with operating mode changeover is used (RAS, RASPT, RAS-PLUS or RAS-F), the set room temperature is only effective in the "**Automatic**" position. The relationship between this variable and T.room setback and T.room frost determines the current operating mode (see Table 2 / Operating levels).
- An ON signal in the **Heating with ext set flow temp.** input variable causes the heating circuit to be operated with **Ext. set flow temp.** as the set flow temperature regardless of whether the pump or mixer are enabled. **Ext. set flow temp.** can be a user defined value or an input variable from a function. This method can be used to cool a collector or a boiler, for example, or to apply the set temperature from the Profile function. When **Heating with ext set flow temp.** is active, the output variables will set the demand temperature to **5.0 °C**, the effective set room temperature to **25 °C**, the operating level to **Special mode (0)** and the operating mode to **Ext set flow t (11)**. The flow temperature will be limited by the thresholds **T.flow max.** and **T.flow min.** (Heat curve menu) even if the **Ext. set flow temp.** value is higher or lower respectively.
- The **Offset** for the set flow temperature can be used to optimize the latter by means of additional criteria (e.g. wind, humidity etc.). This offset value can come from a Curve function, for example. The increase or decrease in the set flow temperature due to the Offset value is limited by T.flow min. and T.flow max. (Heat curve sub-menu).

Parameters	
Operation	Display and selection of the internal operating mode of the heating circuit controller (see Operation sub-chapter)
Room temperature Act. T.room	Display: Room temperature at the T.room room sensor
T.room setback	Set room temperature for setback mode in the internal operating level
T.room standard	Set room temperature for heating mode in the internal operating level
Eff. T.room	Display: Effective set room temperature, as defaulted by the current operating mode.
Flow temperature Act. T.flow Set T.flow Heat curve	Displays: Current flow temperature at the T.flow sensor Calculated set flow temperature Sub-menu: Definition of the heat curve and the maximum and minimum set flow temperatures (see Heat curve sub-chapter)
Mixer Control speed	Matching of the control speed to the heating circuit (setting range 20 % - 500 %) The percentage changes the length of the pulses (but not the time between them), which are emitted to open/close the mixer.
Outside temperature Act. T.outs. Average Derivative time	Display: Outside temperature at the T.outside temperature sensor Sub-menu: Adjusting the outside temperatures for the flow temperature calculation and pump shutdown (see Average sub-chapter) Utilises the Time switch function to shift the point of changeover from setback to standard mode subject to outside temperature (see Derivative time sub-chapter)
Shutdown conditions	Sub-menu: Pump shutdown and mixer conditions (see Shutdown conditions sub-chapter)
Frost protection	Sub-menu: Frost protection conditions (see Frost protection sub-chapter)
<ul style="list-style-type: none"> • In the internal operating level, the Operation setting can be changed from automatic mode (Time/auto) to Standard, Setback or Standby/frost protection. If a RAS, RASPT, RAS-PLUS or RAS-F room sensor is used, then RAS is displayed in automatic mode and the operating mode set on the room sensor is displayed under that. • If a room sensor is specified in the input variables but the sensor lead is short circuited, the heating circuit controller will operate as if there was no room sensor specified in the parameter settings. 	

OPERATION

Operating mode: This defines the mode in which the heating circuit controller operates:

- **Standby** The control function is switched off (frost protection remains active); the set flow temperature is set to +5 °C
- **Frost prot.** The frost protection function is active. (See **Frost protection** section)
- **Setback** The controller has switched to setback mode
- **Standard** The controller has switched to heating (standard) mode
- **Bank holiday** The controller applies the Bank holiday operating mode from the Calendar function
- **Holiday** The controller applies the Holiday operating mode from the Calendar function
- **Party** The controller applies the Party operating mode from the Calendar function

- **Maintenance** The Maintenance function is active (see Maintenance function). The flow temperature is controlled to the T.flow max. setting specified in the **Heat curve** menu (but the display for set flow temperature will show 5 °C). The Maintenance operating mode remains active for three minutes after maintenance mode has been switched off.
- **Ext set flow t** The flow temperature is controlled to the setting specified in the Ext. set flow temp. input variable.
- **Fault** A break in the lead to the outside temperature sensor (captured temperature > 100 °C) would cause the heating circuit to shut down. In the worst-case scenario, that could cause the system to be damaged by frost. To prevent that, if the outdoor temperatures are clearly too high, then the heating circuit is operated according to a fixed outside temperature of 0 °C, and **Fault** is displayed under Operation.

The operating mode displayed in the **Parameters menu** is only the **internal** setting of the controller. In the internal operating status, there is also the **Time/auto** operating mode, in which the **Time condition status** is active. If a room sensor (RAS, RASPT, RAS-PLUS or RAS-F) is defined in the input variables, then the internal operating mode **RAS** is displayed instead. The operating mode set on the room sensor is then displayed under that.

The operating modes **Bank holiday**, **Holiday** and **Party** can **only** be activated by means of the **Calendar function**. The operating mode which is actually active can be seen in the function status screen and in the output variables.

Table 1: Output variable as numeric value subject to **operating mode**

Table 1	
Operating mode	Output variable Numeric value
Inactive (Enable heating circuit OFF)	0
Standard	1
Setback	2
Standby	3
Frost prot.	4
----	5
Holiday	6
Bank holiday	7
Party	8
Fault	9
Maintenance	10
Ext set flow t	11

Operating level: The operating level indicates what defines the operating mode. Priorities are assigned to the operating levels. Operating level 0 has the highest priority; operating level 6 has the lowest priority.

The active operating level can be seen in the function status screen and in the output variables.

Output variable: The numeric value issued indicates the priority of the active operating level and corresponds to **column 1** in **Table 2**.

Table 2			
Priority	Operating level <i>Operating mode</i>	Becomes active if	Comments
0	Special mode		
	0 Inactive	Enable heating circuit = OFF	Heating circuit completely deactivated
	9 Fault	Outside temperature > 100 °C OFF if OT < 75 °C	An outside temperature of 0 °C is applied.
	10 Maintenance	Maintenance function ON	Enable status of pump and mixer irrelevant
	11 Ext set flow t	Heating with ext set flow temp. ON	Digital input signal at the Heating with ext set flow temp. input variable Enable status of pump and mixer irrelevant
	4 Frost prot. if shutdown condition active or Enable pump is OFF	Frost protection condition met (Outside temp. < T.outside AVc or Act. T.room < T.room frost)	
1	Window contact		Digital input signal at the Window contact input variable
	Mode applicable in the current operating level	Window contact ON	
	3 Standby	Window contact OFF	
	4 Frost prot.	Window contact OFF and frost protection condition met	
2	External		Input signal at the External switch input variable
	<i>Time/auto</i>	Signal at the External switch: analogue value 65	Operating mode as per Time condition status (+ RAS: Time/auto)
	1 Standard	Signal at the External switch: analogue value 66	
	2 Setback	Signal at the External switch: analogue value 67	
	3 Standby	Signal at the External switch: analogue value 64	
	4 Frost prot.	Signal at the External switch: analogue value 64 and frost protection condition met	
	Return to the mode applicable in the current operating level	Signal at the External switch: analogue value 127	
	Mode applicable in the current operating level	Signal at the External switch: digital OFF	
	3 Standby	Signal at the External switch: digital ON	
	4 Frost prot.	Signal at the External switch: digital ON, and frost protection condition met	

Priority	Operating level Operating mode	Becomes active if	Description
3	Calendar		Input signal at the Calendar op. mode input variable
	3 Standby	Operating mode as per calendar	
	4 Frost prot.	Standby operating mode as per calendar and frost protection condition met	
	6 Holiday	Operating mode as per calendar	
	7 Bank holiday	Operating mode as per calendar	
	8 Party	Operating mode as per calendar	

4	Internal		
	Time/auto	Operating mode in the controller	Operating mode as per Time condition status
	1 Standard	Operating mode in the controller	
	2 Setback	Operating mode in the controller	
	3 Standby	Operating mode in the controller	
	4 Frost prot.	Standby operating mode in controller and frost protection condition met	

5	RAS		
	Time/auto		If internal mode set to RAS and RASPT, RAS, RAS-Plus or RAS-F is defined as the room temperature sensor
		RAS switch position Automatic	Operating mode as per Time condition status or Ext. set room
	1 Standard	RAS switch position Standard	
	2 Setback	RAS switch position Setback	
	3 Standby	RAS switch position Standby	
	4 Frost prot.	RAS switch position Standby and frost protection condition met	

6	Ext. set room	Analogue input signal at the Set room temperature input variable	If a RAS, RASPT, RAS-Plus or RAS-F is used as the room temperature sensor: only effective with switch set to Automatic . The internal mode must be set to Time/auto .
	1 Standard	Input variable > T.room setback parameter	
	2 Setback	Input variable ≤ T.room setback > T.room frost parameter	
	3 Standby	Input variable ≤ T.room frost	
	4 Frost prot.	Input variable ≤ T.room frost and frost protection condition met	

- The **frost protection condition** is **met** if the **average** outside temperature for **shutdown** T.outside Av.c. is less than the set value in the Frost protection menu **or** the room temperature Act. T.room is less than T.room frost.
- The special operating mode **Fault** only becomes active if **Maintenance** and **Ext set flow t** are inactive.

Status of heating circuit pump and mixer

subject to operating mode and enable:

Enable heating circuit	Operating mode	Enable pump	Enable mixer	Pump status	Mixer status
OFF	x	x	x	OFF	OFF
ON	Maintenance Ext set flow t	x	x	ON	AUTO (1)
	Standard, Setback, Party, Holiday, Bank holiday	OFF	OFF	OFF	OFF
			ON	OFF	OFF (2)
	Standby	ON	OFF	AUTO	OFF
			ON	AUTO	AUTO
	Frost protection	x	ON	ON	AUTO
		OFF	ON	OFF	

x... Enable status / operating mode is irrelevant

(1)... In this case AUTO means that the heating circuit will be controlled to the T.flow max. setting specified in the Heat curve menu.

(2)... OFF does **not** apply if heating circ. pump = off => Mixer: is set to **Control** in the shut-down conditions.

EXTERNAL SWITCH

If a **digital signal** (ON/OFF) is connected to the External switch input variable, it is possible to switch between standby/frost protection mode and the current operating mode of a lower-priority operating level. If the input signal is set to ON, the controller switches to Standby or, if the frost protection conditions are met, to Frost protection. If the signal is set to OFF, the controller switches to the currently applicable operating level.

The input variable also accepts **analogue** values for external operating mode changeover:

Value (dimensionless):	Operating mode:
64	Standby/frost protection
65	Time/auto (operating mode as per Time condition status)
66	Standard
67	Setback
127	Return to the mode applicable in the current operating level.
0	Does not cause a change in the operating mode, but a change may be caused subsequently by a lower-priority operating level.

These analogue values can come from another function, or via the GSM module of the C.M.I. as a network input. The values from the external switch have priority 2 (see Table 2 in the OPERATION chapter).

N.B.: If, during the time when the value is between 64 and 67, an attempt is made to set a different operating mode in an operating level with lower priority (= Calendar, External set room temperature, RAS and Internal), the controller will remember that change and will apply that operating mode if control is returned with a value of **127** from the External switch.

Important note: The external switch must **never** be linked to a temperature sensor, as doing so could cause damage to the controller.

CALENDAR

The **Calendar op. mode** input variable selects the operating mode of a Calendar function.

In the **Calendar set room t** input variable, it is possible to specify the **set value** (=set room temperature) **1, 2** or **3** assigned to the operating mode. However, any other source is permitted as well (e.g. a calendar set room temperature from another controller via the CAN network).

If **no** set temperature is defined for the operating mode (unused), the controller then has the following effective set room temperatures:

Calendar operating mode	Effective set room temperature
Inactive (0)	T.room setback or T.room standard according to the Time condition status
Standby (3)	5°C, frost protection function active
Holiday (6)	T.room setback
Bank holiday (7)	T.room standard
Party (8)	T.room standard

If two or more calendar operating modes are active **simultaneously**, the operating mode with the highest priority (see Calendar function) is applied together with the corresponding set value.

If no calendar operating mode is active (**Inactive (0)** is displayed in the input variables), the calendar set room temperature defined in the Calendar function for **Inactive** will be displayed in the input variables. That value will **not** be applied in the heating circuit function, however.

WINDOW CONTACT

The Window contact input variable allows the heating circuit to be switched to Standby and Frost protection independently of the other operating levels (with the exception of Special mode – Maintenance and Ext set flow t).

A (digital) ON signal leaves the heating circuit in the current operating level and operating mode; an OFF signal activates Standby or Frost protection mode.

TIME PROGRAMS

The heating circuit's time programs are defined via the **Time condition status** input variable. The status is effective in the **Time/auto** operating mode only. If the status is ON, the standard temperature applies; if the status is OFF, the setback temperature applies. This status can come from functions (such as the **Time switch** function) or from other sources. If a set room temperature from the Time switch function is selected, note that **outside** the time window the Set value (1, 2) if time prog. = Off will be applied.

DERIVATIVE TIME

Rigidly defined heating times may cause heating to start too early or too late, depending on the outside temperature. The derivative time shifts the switching point **subject to the outside temperature**. The time entered is in reference to an outside temperature of -10 °C and is zero at +20 °C. For example, if the derivative time is 30 min and the outside temperature is 0 °C, the switching time (for changeover from setback to standard mode) is brought forward by 20 minutes. The effective derivative time according to the average outside temperature is an output variable and can be applied by the **Time switch** function.

HEAT CURVE

The flow temperature is usually calculated from the **outside temperature** and the heating curve parameters. The heat curve is calculated based on a set room temperature of +20 °C and is offset in parallel for other set room temperatures.

The function allows you to set parameters for the heat curve in two ways:

- By means of the **slope** as is common in many heating control units.
- By means of the relationship between the **outside temperature** (at +10 °C and -20 °C) and the flow temperature. Here, another reference point is set at +20 °C outside temperature = +20 °C flow temperature.

In both of these methods, the influence of the outside temperature on the flow temperature is **not linear**.

With the **slope** method, the curvature is defined according to standard conditions.

With the **temperature** method, the flow temperature required for +10 °C produces a curvature of the heating curve that can be adjusted to match the thermal output of different heating systems.

Fixed value: The flow is controlled to the fixed values set in the Heat curve sub-menu for Standard mode and Setback mode. The **room influence** remains active in **Fixed value** mode as well. If there is no outside temperature sensor connected, a value of 0 °C for the outside temperature is set internally in the controller. For the **Standby** operating mode to function correctly, the **T.outside av.c.** parameter in the **Frost protection** menu should be set **below 0 °C**.

With no outside temperature sensor the heating circuit control operates as **fixed value control** where the flow temperature in standard mode corresponds to the T.flow -20 °C setting and the flow temperature in setback mode corresponds to the T.flow +10 °C setting (Heat curve sub-menu).

Slope heat curve

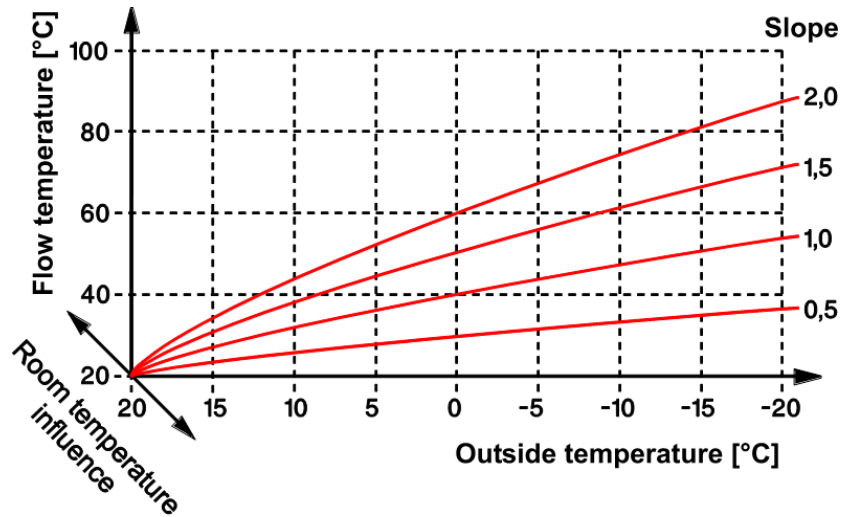

Temperature heat curve (examples)

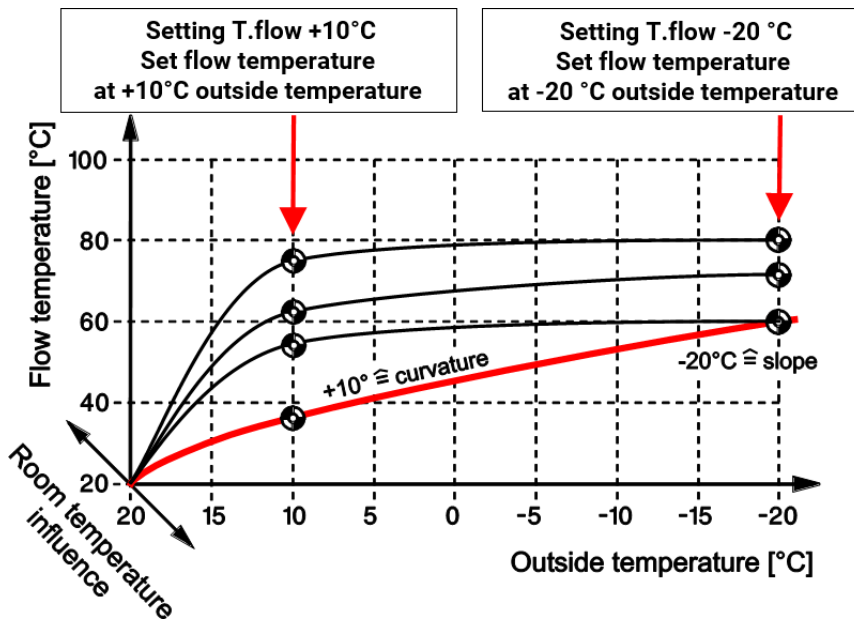

Parameters in Heat curve sub-menu	
Control	Available for selection: <i>Outside temperature</i> mode or <i>Fixed value</i> mode
Heat curve (shown only for Outside temperature mode)	Available for selection: <i>Temperature</i> or <i>Slope</i>
Room influence	The room temperature is factored xx % into the flow calculation (non-linear influence). Setting range: 0 - 90 %. The room influence is active in Fixed value mode as well.
Start excess	The preceding OFF time of the heating circuit pump leads to a boost in the flow temperature (to no more than T.flow max.) which fades out over time. Setting range: 0 – 20 % ⇒ for detailed explanation see below
T.flow +10 °C (shown only for Temperature heat curve)	Required flow temperature at +10 °C outside temperature
T.flow -20 °C (shown only for Temperature heat curve)	Required flow temperature at -20 °C outside temperature
Slope (shown only for Slope heat curve)	Specifies the slope
T.flow setback (shown only for Fixed value mode)	Required flow temperature in setback mode
T.flow standard (shown only for Fixed value mode)	Required flow temperature in standard mode
Level	Parallel shift of the selected heat curve by applying a fixed offset value (active in Fixed value mode as well). The calculated set flow temperature will be increased or decreased by this amount.
T.flow max.	Maximum flow temperature (the flow must not rise above this limit)
T.flow min.	Minimum flow temperature for every operating mode except Standby (the flow must not drop below this limit)
T.flow min. standard	Minimum flow temperature in standard mode
<ul style="list-style-type: none"> • Start excess The start excess (SE) is calculated according to the following formula: $\text{T. flow. set}_{SE} = \text{T. flow. set} + \left(\text{T. flow. set} \times \frac{SE}{100} \times \frac{\text{meter}}{30} \right)$ <p>The counter goes up by 1 for every 20 minutes that the heating circuit pump is switched off, and drops by 1 every minute that the pump is switched on until it reaches 0. The maximum counter reading is 255. It is thus reached after 85 hours of OFF time (= 255/3 hours or about 3.5 days). The maximum fade-out time is 4.25 hours (= 255 minutes). The set excess in % is effective after an OFF time of 10 hours (= 30 x 20 minutes). Example: T.flow.set = 40 °C, Start excess = 10 %, OFF time 8 hours The excess is initially +3.2 K and falls steadily to zero within 24 minutes.</p> • If T.flow min. standard is set lower than T.flow min., the higher value of T.flow min. will apply in standard mode anyway. 	

Parameters in Average sub-emu (adjusted outside temperature)

Fluctuations in outside temperatures can sometimes be undesirable when calculating the flow temperature or when those temperatures form the basis of heating circuit pump shutdown. Therefore, a separate calculation of the adjusted outside temperature is available for heating curve calculation and for pump shutdown.

For flow control	Adjustment for calculating the set flow temperature
Aver. time	Entry for the averaging time
Average OT for control	Result of the calculation
For shutdown	Adjustment for the pump shutdown conditions
Aver. time	Entry for the averaging time
Average OT for shutdown	Result of the calculation

Parameters in Shutdown conditions sub-menu (including mixer action)

The controller allows the following shutdown conditions for the heating circuit pump:

if standard mode and T.room	Shutdown when the room temperature required in standard mode has been reached.
Act. > set	
Diff. on	Start differential for Eff. T.room
Diff. off	Stop differential for Eff. T.room
if setback mode and T.room	Shutdown when the room temperature required in setback mode has been reached.
Act. > set	
Diff. on	Start differential for Eff. T.room
Diff. off	Stop differential for Eff. T.room
if T.flow	Shutdown when the calculated flow temperature falls below the T.flow min. threshold in heating or setback mode.
Set < min.	
Diff. on	Start differential for T.flow min.
Diff. off	Stop differential for T.flow min.
if T.flow	Shutdown when the flow temperature is higher than T.flow max. (setting in the heat curve).
Act. > max.	
Diff. on	Start differential for T.flow max.
Diff. off	Stop differential for T.flow max.
if T.outside	Shutdown if the average outside temperature T.outside AVo exceeds the adjustable value T.outside max. in heating or setback mode .
Aver.off > max.	
T.outside max.	Required threshold value
Diff. on	Start differential for T.outside max.
Diff. off	Stop differential for T.outside max.
if setback mode and T.outside	Shutdown if the average outside temperature T.outside AVo exceeds the adjustable value T.outside max. in setback mode .
Aver.off > max.	
T.outside max.	Required threshold value
Diff. on	Start differential for T.outside max.
Diff. off	Stop differential for T.outside max.

Parameters in Shutdown conditions sub-menu (including mixer action)	
if heating circ. pump = off Mixer	Mixer action after shutdown of the pump (unless Enable heating circuit = Off): Available for selection: <i>Close, Open, Unchanged, (continue to) Regulate</i>
if enable mixer = off Mixer	Mixer action when Enable mixer = Off: Available for selection: <i>Close, Open, Unchanged</i>
<ul style="list-style-type: none"> • If one of the shutdown conditions is active, the heating circuit pump will be shut down and the set flow temperature will be set to +5 °C. • If an external set room temperature is specified (input variable), shutdown conditions apply as follows: <ul style="list-style-type: none"> • If the value of the input variable is \geq the standard temperature parameter T.room standard, the heating circuit is in standard mode. Therefore the shutdown conditions for standard mode apply. • If the value of the input variable is \geq the setback temperature parameter T.room setback and $<$ T.room standard, the heating circuit is in setback mode. Therefore the shutdown conditions for setback mode apply. • None of the parameter values have an adjustable hysteresis. The switching thresholds are each divided into a start differential and a stop differential. <ul style="list-style-type: none"> • As the calculation of the set flow temperature incorporates both the outside temperature and the room temperature (provided a sensor is in use), the shutdown if T.flow Set < min. is the method used most frequently. This shutdown condition is the controller factory setting. • The mixer action for "if enable mixer = off" is dominant over "if heating circ. pump = off". 	

Parameters in the Frost protection sub-menu	
<p>This function section becomes active in Standby mode in any operating status, even if the heating circuit is currently partially disabled via the Enable pump input variable or if a shutdown condition would prevent operation of the heating circuit pump.</p> <p>If Enable mixer is set to OFF, the pump remains switched on and frost protection mode does not apply. The mixer acts according to the setting in the shutdown conditions for mixer action when Enable mixer = OFF.</p> <p>If the function is blocked by Enable heating circuit, frost protection will not operate!</p> <p>Frost protection is activated when the outside temperature falls below "T.outside av.c.<", the flow temperature is below "T.flow<" or, if a room sensor is connected, the room temperature falls below "T.room frost".</p> <p>When frost protection is activated, the set flow temperature is set to the flow temperature on the heat curve that corresponds to the room temperature T.room frost, but must be at least T.flow min. or T.flow min. standard according to the time condition status (setting in the Heat curve sub-menu).</p> <p>If there is no outside temperature linked to the function, the value for the average outside temperature is set to 10.0 °C. In this configuration, the frost protection mode is not activated by the outside temperature if the frost protection threshold T.outside av.c is below 10.0 °C.</p> <p>Frost protection mode ends when the temperature that triggered the frost protection function rises 2 K above the applicable frost protection limit (fixed hysteresis).</p>	
Frost protection if	
T.outside av.c. <	Start threshold via the outside temperature
T.room frost	<ul style="list-style-type: none"> • Start threshold via the room temperature • Set room temperature for frost protection mode

Parameters in the Frost protection sub-menu

Changeover from standard to setback mode

Frost protection delay	If frost protection mode is triggered via the outside temperature threshold when changing from standard to setback mode, it can only become active after this delay.
------------------------	---

Output variables

Set flow temperature	Issue of the current set flow temperature in accordance with Table 3, Output variables under various conditions (for mixer control)
Effective set room temp.	Issue of the effective (= current) set room temperature
Htg circ. pump	Heating circuit pump status ON/OFF; selection of the output
Open/close mixer	Mixer status OPEN/OFF/CLOSE; selection of the switching outputs (dual output)
Mixer 0 – 100 %	A percentage value to one decimal place, for control of a mixer with 0-10 V input via an analogue output
Maintenance mode	Status ON if maintenance mode is active
Frost protection mode	Status ON if frost protection mode is active
Operating mode	Display of the operating mode together with a dimensionless number in accordance with Table 1 in Operation sub-chapter
Operating level	Display of the operating level together with a dimensionless number in accordance with column 1 (Priority) in Table 2 in Operation sub-chapter
Derivative time	The effective derivative time subject to outside temperature
T.room < set	Status OFF if the shutdown condition Act. T.room > set is met
T.room < set (setback)	Status OFF if the shutdown condition Act. T.room > set in setback mode is met.
T.flow set > min.	Status OFF if the shutdown condition T.flow set < min. is met.
T.outside < max.	Status OFF if the shutdown condition T.outside AVo > max. is met.
T.outside < max. (set-back)	Status OFF if the shutdown condition T.outside AVo > max. in set-back mode is met.
T.flow < max.	Status OFF if the shutdown condition Act. T.flow > max. is met.
Remaining runtime ctr	Display of the remaining mixer runtime
Mixer open	Status ON when the mixer is fully open (after expiry of remaining runtime)
Mixer closed	Status ON when the mixer is fully closed (after expiry of remaining runtime)
Average OT for control	Calculated adjusted outside temperature, utilised for calculation of the flow temperature (see Average sub-chapter)
Delay timer, frost prot.	Display of a countdown of the Delay for frost protection mode when changing from standard to setback mode
Delay timer, frost prot.	Display of a countdown of the Delay for frost protection mode when changing from standard to setback mode

- Mixer 0 – 100 %: Scaling of the analogue output: $0 = 0.00 \text{ V} / 1000 = 10.00 \text{ V}$
- The remaining runtime counts down from 20 minutes when an output pair (mixer drive) is linked to the "Open/close mixer" output variable. If an output pair is not linked, the remaining runtime counts down from 2 minutes.
- If the **runtime limit** was deactivated in the **mixer output** settings, the remaining runtime only counts down to 10 seconds and output pair control is not terminated.
- The remaining runtime is reloaded if the mixer output is switched to manual mode, is switched by a message (to dominant ON or OFF), changes its direction of control, or if Enable is switched from OFF to ON.
- **Mixer open / closed:** If the runtime limit was deactivated, the mixers are still displayed as open or closed after the remaining runtime is complete.
- The output variables that refer to shutdown conditions are always in status ON if the applicable shutdown condition has **not** been activated.

Table 3 Output variables under various conditions

	Frost protection condition met Yes/No	Set flow temperature	Set demand temperature	Effective set room temperature
Enable heating circuit OFF	---	5.0 °C	5.0 °C	5.0 °C
Enable pump OFF	Yes	Frost protection calculation (with delay)	Calculation	T.room.frost
Enable pump OFF	No	Calculation	Calculation	As per settings
DHW priority ON	Yes	Frost protection calculation	Calculation	T.room.frost
DHW priority ON	No	Calculation	Calculation	As per settings
Enable mixer OFF	---	Calculation	Calculation	As per settings
Pump shutdown condition active	Yes	Frost protection calculation (with delay)	Frost protection calculation (with delay)	T.room.frost
Pump shutdown condition active	No	5°C	5°C	As per settings
All operating modes except Standby	---	Calculation	Calculation	As per settings
Standby operating mode ----- Window contact OFF	Yes	Frost protection calculation	Frost protection calculation	T.room.frost
Standby operating mode ----- Window contact OFF	No	5 °C	5 °C	5 °C
Heating with ext set flow temp.	---	Ext. set flow temp.	5 °C	25 °C
Maintenance	---	T.flow max.	5 °C	25 °C

Blind control

Function description

In Auto mode, Blind control applies the set position from the Shading function.

Digital input signals (from blind switches/pushbuttons) allow you to change over to manual mode and to open or close blinds or to position their slats horizontally.

A safety shutdown, which may be activated by a wind sensor for example, can move the blind into a predefined position, overriding any other settings.

Input variables

Enable	General enabling of the function (digital value ON/OFF)
Enable auto mode	Digital input signal, ON/OFF
Open blind	Digital input signal, ON/OFF
Close blind	Digital input signal, ON/OFF
Fully open blind	Digital input signal ON (pulse)
Fully close blind	Digital input signal ON (pulse)
Trigger auto mode	Digital input signal ON (pulse)
Safety shutdown	Digital input signal (ON/OFF) which activates a dominant action by the blinds as specified in the parameters
Auto mode set position	Input signal from the Shading function (xx% / xx%)
Door contact	Digital input signal, ON/OFF
Switching to auto mode at	Time at which manual mode switches back to auto mode or a switch is made to auto mode with a digital ON pulse or switching is deactivated though a digital OFF signal

- The input variables **Open blind** and **Close blind** require digital switching signals. The function **terminates** auto mode and opens/closes the blind for as long as the input signal is **ON**. If the **Long click time** (parameters) is exceeded or a double click is performed within the **Double click** time, the blind is opened or closed **fully**.
- The function switches from manual mode to auto mode if in manual mode **Open blind** and **Close blind** are activated **simultaneously**.
- The input variables **Fully open blind** and **Fully close blind** are activated by **pulse signals**. We therefore recommend the use of blind pushbuttons with no interlock between OPEN and CLOSE.
- **Triggering auto mode** activates a return from manual mode to auto mode. The signal does not take effect until the blind reaches the position specified by the previous manual operation.
- Buttons for "Trigger auto mode", "Open blind", "Close blind", "Fully open blind", "Fully close blind" and "Set horizontally" are provided in the parameter menu.
- Safety shutdown becomes active if the input signal is set to ON.
- If the **Door contact** input variable is set to **OFF**, the blind is **opened** (output: 0 % / 0 %) and the Auto mode status switches to **OFF**.
- Further manual operation is not possible until the door contact switches back to **ON** and the function is switched to **auto** mode. This allows this input variable to be used as a **child lock** as well.
- **Switching to auto mode:** Switching is deactivated if a digital OFF signal is present.
- **Set horizontally:** A digital ON pulse sets the slats to horizontal in line with parameter "**Slats horizontal at**". The function is then in manual mode.

Parameter	
Blind settings Slat time Slat idle time Slats horizontal at Direction change delay Delay	Time taken by the slats to move from horizontal to closed Idle time in a change of direction; option of correcting to compensate for wear of blind after a long period of use Value for horizontal slat position for the input signal "Set horizontally" Specifies a delay when changing direction Specifies a delay for auto mode commands
Manual mode Long click time Double click time Manual height setting Manual inclination setting	If the long click time is exceeded for the input signals Open blind or Close blind , the blind will be opened or closed fully (enter value = 0 to deactivate). If two pulses are received within the double click time on the input variables Open blind or Close blind , the blind will be opened or closed fully (enter value = 0 to deactivate). Required height for manual mode Required inclination for manual mode
Closing conditions if enable = off if enable auto mode = off if safety shutdown	Action of the function if Enable = OFF. Action of the function if Enable auto mode = OFF. Action of the function when the safety shutdown is active. Available for selection: Close, Open, Unchanged
Trigger auto mode Open blind Close blind Fully open blind Fully close blind	Buttons for switching to auto mode, manual mode and horizontal setting of the blind slats
<ul style="list-style-type: none"> • Direction change delay: Applies in both manual and automatic mode. Some blind manufacturers specify a delay when changing directions, in order to reduce wear on the drive. • Delay: Applies only in automatic mode. If this delay is set differently in different blind functions, the blinds will not be moved simultaneously by the Shading function. • Manual inclination and height settings: If users select one of these two parameters in automatic or manual mode, the selected blind position will be issued as the set position, even if users have not changed the value. In any case the function will then be in manual mode (Auto mode = Off). 	

Output variables	
Open/close blind	Blind status OPEN/OFF/CLOSE; selection of the switching outputs (dual output)
Set position	Specified set position Two percentages are included in this output: 1st percentage: slat position, 0 % = horizontal, 100 % = vertical 2nd percentage: blind up (= 0 %) or down (= 100 %)
Actual position	Actual position; may differ from the set position by a few % if the time taken by slat movement or motor runtime is short.

Output variables	
Auto mode status	Status ON if in auto mode Status OFF if in manual mode, if Enable auto mode = OFF or if door contact was actuated
Delay timer	Display of a countdown of the delay in seconds
<ul style="list-style-type: none"> • If "Roller shutter" is set (parameter "Slats: No"), the first percentage of the set position and the slat set position is always 0 %. • The blind runtime required to move the blind from fully up to fully down is set as "Runtime" in the output pair. The function will not work until the output pair is defined. • If the set position was specified as fully open (0 %/0 %) or fully closed (100 %/100 %), then a change in set position will not become active until the end position has been reached (actual position). • If the general Enable is switched off, the blind will act in line with the if enable = off parameter. • If Enable auto mode is switched off, the function will change to Manual mode, and the blind will act in line with the if enable auto mode = off parameter. If Enable auto mode is then switched back ON, the function will stay in Manual mode. • A changeover from manual to auto mode can only be brought about by an On pulse on Trigger auto mode, simultaneous actuation of Open blind and Close blind or by Switching to auto mode at. 	

Calendar

Function description

The Calendar function makes it possible to operate the heating circuit controller in the operating modes *Party*, *Holiday*, *Standby* and/or *Bank holiday* in priority level 3. There are 10 date windows available for this purpose. Three different set temperatures can be assigned to each operating mode.

However, it is also possible to issue set values and statuses for other functions as the output in the specified date windows.

The operating modes are explained in more detail in the chapter "**Operation**" for the **Heating circuit ctrl** function.

Input variables

Enable	General enabling of the function (digital value ON/OFF)
Holiday derivative time	Analogue value in minutes for bringing the ON time forward for "Holiday" operating mode
Party derivative time	Analogue value in minutes for bringing the ON time forward for "Party" operating mode
Bank holiday derivative time	Analogue value in minutes for bringing the ON time forward for "Bank holiday" operating mode
Standby derivative time	Analogue value in minutes for bringing the ON time forward for "Standby" operating mode
<ul style="list-style-type: none"> • With Enable OFF, all statuses will be set to OFF, the operating mode will show Inactive (0) and the set values for Inactive will be issued • The sources for the derivative times can be other functions (e.g. heating circuit control, curve function). This allows the use of flexible start and stop times which vary depending on other parameters (e.g. the outside temperature). 	

Parameters

Function quantity	Select the function quantity for the set values. A wide range of function quantities are available, which are applied together with their unit and their decimal places.
Inactive	Enter the analogue set values for Inactive operating mode and for Enable = Off.
Party	Enter the analogue set values for Party operating mode.
Holiday	Enter the analogue set values for Holiday operating mode.
Standby	Enter the analogue set values for Standby operating mode.
Bank holiday	Enter the analogue set values and the time window for the Bank holiday operating mode.
Date window 1-10	Access to the sub-menu for each Date window 1 – 10 to set the parameters

Parameters in Inactive, Party, Holiday or Standby sub-menu

Set value	
Set value 1	Enter analogue set value 1
Set value 2	Enter analogue set value 2
Set value 3	Enter analogue set value 3
<ul style="list-style-type: none"> • The set values are available as output variables inside the date window. 	

Parameter Untermenü Feiertag

Within time window	
Set value 1	Enter analogue set value 1
Set value 2	Enter analogue set value 2
Set value 3	Enter analogue set value 3
Outside time window	
Set value 1	Enter analogue set value 1
Set value 2	Enter analogue set value 1
Set value 3	Enter analogue set value 3
Time windows 1-5	Up to 5 time windows can be entered for the Bank holiday mode
<ul style="list-style-type: none"> A distinction is made between set values inside the time window and set values outside the time window. These set values are available as output variables inside the date window. 	

Parameters for Date window 1 - 10 sub-menu

Operating mode	Available for selection: <i>Inactive, Party, Holiday, Standby, Bank holiday</i>
Occurrence	Available for selection: <i>Once</i> or <i>Annually</i>
From	Enter the date, time
To	Enter the date, time
<ul style="list-style-type: none"> The operating mode selected will become active inside that date window. 	

Output variables

Status holiday	Status ON if Holiday mode is active										
Status party	Status ON if Party mode is active										
Status bank hol.	Status ON if Bank holiday mode is active										
Status standby	Status ON if Standby mode is active										
Operating mode	The active operating mode (together with the operating mode number)										
Set value 1	Set value 1 for that operating mode										
Set value 2	Set value 2 for that operating mode										
Set value 3	Set value 3 for that operating mode										
<ul style="list-style-type: none"> If more than one operating mode is active simultaneously, then the calendar operating mode with the highest priority will be issued together with its set values. Operating modes have the following priority: <table border="0"> <tr> <td>Operating mode</td> <td>Priority level</td> </tr> <tr> <td>Party</td> <td>1 (highest priority)</td> </tr> <tr> <td>Holiday</td> <td>2</td> </tr> <tr> <td>Standby</td> <td>3</td> </tr> <tr> <td>Bank holiday</td> <td>4 (lowest priority)</td> </tr> </table> The link to the heating circuit or cooling circuit function is described in the chapters for those functions. 		Operating mode	Priority level	Party	1 (highest priority)	Holiday	2	Standby	3	Bank holiday	4 (lowest priority)
Operating mode	Priority level										
Party	1 (highest priority)										
Holiday	2										
Standby	3										
Bank holiday	4 (lowest priority)										

Cascade

Function description

Coordination of up to 8 demand signals with minimum runtime and delay.

The input variables for the cascade stages inform the module of the status of each of the demand signals. The digital input signals for the cascade stages can come from heating, DHW or cooling demands. But any other digital signal can also be used for this (e.g. a signal from another function or from an input). This allows a high degree of programming freedom in the use of the Cascade function.

Input variables

Enable	General enabling of the function (digital value ON/OFF)
Enable generator A - H	Digital input signal, ON/OFF, for separate enabling of the 8 possible generators (digital value, ON/OFF)
Cascade stage 1 - 8	Digital input signal, ON/OFF, for control of the 8 possible cascade stages (digital value, ON/OFF)

- Designations **A – H** refer to the **generators** themselves, which is to say the boilers or heat pumps, for example. The associated index (e.g. **A1**, **A2**, **A3**, etc.) relates to the stages of the generator, if a multi stage generator is being used.
- Designations **1 - 8** refer to the cascade **stages** that are currently active.
- **Enable generator A – H:** This allows individual generators to be blocked, removing them from the control structure of the cascade stages. Blocked generators are skipped in the sequence of stages. When using a multi stage generator, each stage of the generator can be enabled.
- **Cascade stage 1 – 8:** These input signals can come from the Demand output variable of one or more heating demand functions. But any other digital signal can also be used for this (e.g. a signal from another function or from an input).

Parameter	
Cascade stages settings	Sub-menu for setting the delay for each individual cascade stage
Generator settings	Sub-menu for: <ul style="list-style-type: none"> • Generator assignment (single or multi stage generator) • Setting the minimum runtimes • Assigning the generator sequence • Selecting the generators for automatic generator change • Difference in hours run for generator change
Hrs run diff. for generator change Difference hours run	The hours run differential after which an automatic generator change take place
Reset hours run, generator A- H, or all	The hours run meters of the heat generators can be reset individually or all together.
<ul style="list-style-type: none"> • The delays for individual stages start running with the first activation of a stage. • Generator sequence for multi stage boilers: the stages following the 1st stage are subsequently added to the generator sequence. • Example: with a 3-stage boiler A, if generator A1 is 3rd in the sequence (= 1st boiler stage), then boiler stages A2 and A3 come 4th and 5th. • Conditions for generator change: <ul style="list-style-type: none"> • If there are 2 or more generators, the change must be approved. • Every 10 minutes, the system checks whether the generator sequence should be changed. • If the difference in hours run is greater than the set differential, the change will be carried out, provided that the generators affected by the change are either all ON or all OFF. • If the difference in hours run is greater than twice the set differential, the change will be carried out regardless of whether all the generators are ON or OFF. 	
Delay times of individual stages In this example, stage 1 has no time delay.	
<p>The diagram shows three horizontal timelines for Stage 1, Stage 2, and Stage 3. Stage 1 starts at time 0. Stage 2 starts after a delay from Stage 1's first activation. Stage 3 starts after a delay from Stage 2's first activation. The diagram shows that the delay is only effective for the first activation of each stage.</p>	
The time delay of each individual stage is only effective for the first activation since the last deactivation of the first stage.	

Output variables	
Generator A - F demand	Status ON/OFF of generators A-H; selection of the switching outputs
Status stage 1 - 8	Status ON/OFF of demand stages 1-8
Hours run A - H	Issue of the current hours run of generators A-H
Delay timer, generator	Countdown of the current delay (after the first demand is switched on)
Min. runtime ctr. A - H	The remaining minimum runtime
Rank generator A - H	Display of the current priority of the generator, factoring in the generator change.
Cascade stage	Display of the current cascade stage
<ul style="list-style-type: none"> • If a higher cascade stage is switched on before the lower stages, all preceding stages will be switched on as well, subject to the delay. In other words, if only stage 4 switches on, stages 1 – 4 will be switched on. • The stage is switched on immediately if the delay of a cascade stage has already expired when that stage is switched on. • The parameter menu provides the option of resetting the hours run meters, individually or all together. • ATTENTION: The meter readings of the hours run meters are saved to the internal memory every hour. Therefore, in the event of a power failure, no more than 1 hour of metering can be lost. • When loading function data, you will be asked whether you want to apply the saved meter readings (see manual Programming Part 1: General information). 	

Example 1

Two-stage boiler cascade with two heating demands (with only one demand sensor)

Example 1: Input variables for Heating demand 1

Set demand temperature	Function / DHW demand / Effective set temperature
------------------------	--

Example 1: Parameters for Heating demand 1

Demand temperature	
T.dem. set	Effective set temperature for DHW demand
Diff. on	-8,0K
Diff. off	2,0K

Example 1: Input variables for Heating demand 2

Set demand temperature	Function / DHW demand / Effective set temperature
------------------------	--

Example 1: Parameters for Heating demand 2

Demand temperature	
T.dem. set	Effective set temperature for DHW demand
Diff. on	-13,0K
Diff. off	-2,0K

Example 1: Input variables for cascade

Enable	ON
Enable generator A	ON
Enable generator B	ON
Cascade stage 1	Function / Heating demand 1 / Demand / Standard
Cascade stage 2	Function / Heating demand 2 / Demand / Standard

Example 1: Parameters for cascade

Cascade stages settings	Sub-menu for setting the delay for each individual cascade stage: Delay 1: 0 seconds Delay 2: 15 minutes
Generator settings	Sub-menu for setting the minimum runtimes , assigning the generator sequence and selecting the generators for the automatic generator change : Minimum runtimes: both 0 Generator sequence assignment: A: 1 B: 2 Automatic generator change: A and B: Yes
Hrs run Diff. for generator change	7 days

Runtime chart for example 1

Assumption: Sudden jump in set flow temperature to 55 °C (= effective set temperature for DHW demand)

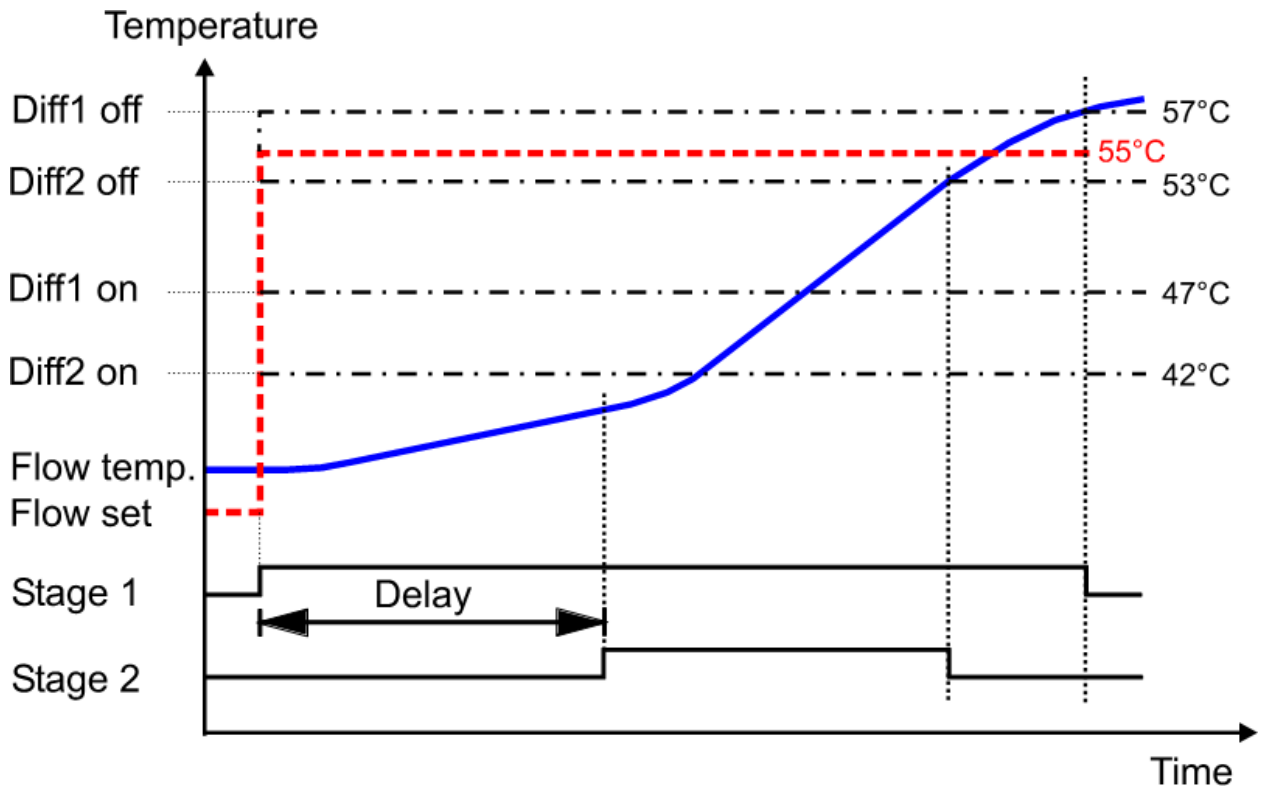

Example 2

Automatic pump change

In large systems, a second pump is used as a backup. There is only ever one pump switched on in the standard operating mode. The Cascade function can be used to carry out an automatic pump change to even out the wear and tear on pumps.

Example 2: Input variables for cascade

Enable	ON
Enable generator A	ON
Enable generator B	ON
Enable generator C - H	OFF
Cascade stage 1	e.g. Function / Charging pump / Charging pump / Standard

Example 2: Parameters for cascade

Cascade stages settings	Sub-menu for setting the delay for each individual cascade stage: All delays: 0 seconds
Generator settings	Here, the word generator refers to the pumps . Sub-menu for setting the minimum runtimes , assigning the generator sequence and selecting the generators for the automatic generator change : Minimum runtimes: both 0 Generator sequence assignment: A: 1 B: 2 Automatic generator change: A and B: Yes
Hrs run Diff. for generator change	Here too, the word generator refers to the pumps . Example: 7 days

- Conditions for pump change:
 - Every 10 minutes the controller checks whether the pump sequence should be changed.
 - The change must be permitted for both 'generators' (in this case: pumps).
 - If the difference in hours run is greater than the set differential the change will be carried out if **all** the pumps affected by the change are either ON or OFF.
 - If the difference in hours run is greater than **twice** the set differential, the change will be carried out regardless of whether all the pumps are ON or OFF.
- As only one pump is **ever** switched on at a time, the pump change only occurs after **twice** the set differential time, which in this example is after 14 days of pump operation.

Curve function

Standard diagramm

Examples of a 3D plot and a 2D curve

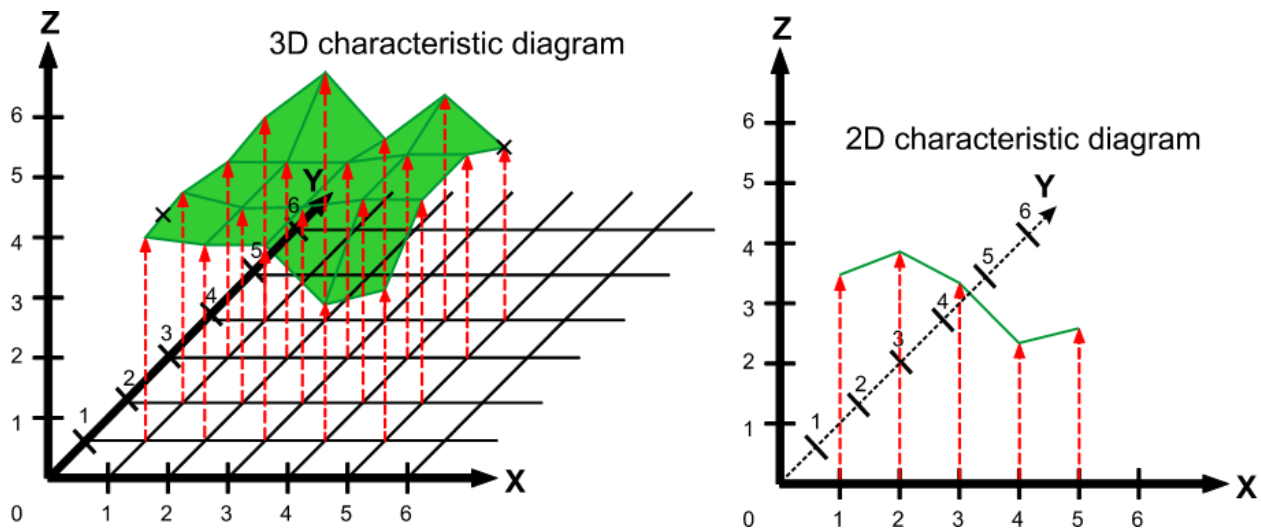

Function description

The Curve function allows a Z value to be assigned to X and Y values (**3D plot**). These values can also be signed as negative values.

In the example in the standard diagram, 20 Z values were defined for 5 X values and 4 Y values.

If only 1 Y value is defined (standard diagram example: $Y = 0$), a **2D curve** will be generated.

The intermediate values between the defined points are interpolated by the function. There is no extrapolation of values outside the defined range. If the point lies beyond the defined points, the output will indicate the height of the point where it exited the 3D plot or 2D curve.

Separate function quantities can be specified for X, Y and Z values.

Input variables

Enable	General enabling of the function (digital value ON/OFF)
Z (enable = Off)	Analogue value for the Z value (= result) when Enable is OFF
X	Analogue input signal for the X value
Y	Analogue input signal for the Y value

Parameters	
Function quantity X Function quantity Y Function quantity Z	You can specify a separate function quantity for each value. A wide range of function quantities are available, which are applied together with their unit and their decimal places.
No. X values No. Y values	Define the number of values in each case. Up to 10 values can be specified per axis (resulting in up to 10x10 = 100 defined Z values)
X values Y values Z values	Sub-menus for entering the X and Y values and the corresponding Z values

Example: The Z values should be offset values determined by the outside temperature and wind speed:

X1 = -20 °C
X2 = +20 °C
Y1 = 10 km/h

The corresponding Z values are 4.0 and 1.0 K respectively

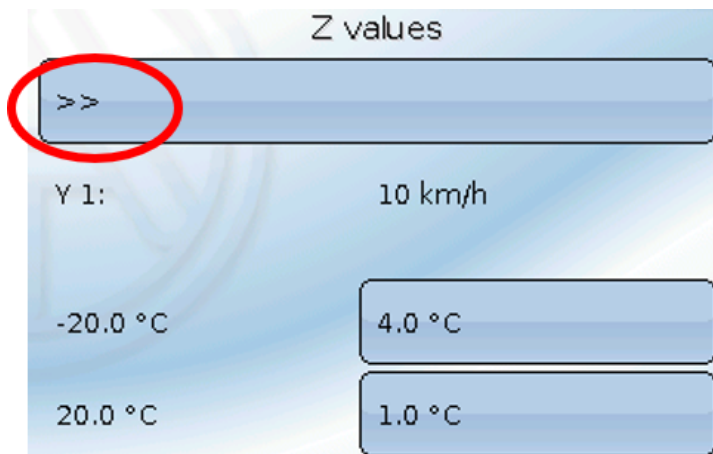

Tapping the arrow causes the next Y value to be displayed.

- If the number of Y values is set to 1, the result is a 2D curve.
- If only 2 X values and 1 Y value are defined, the result is a **straight 2D line**.

Example:

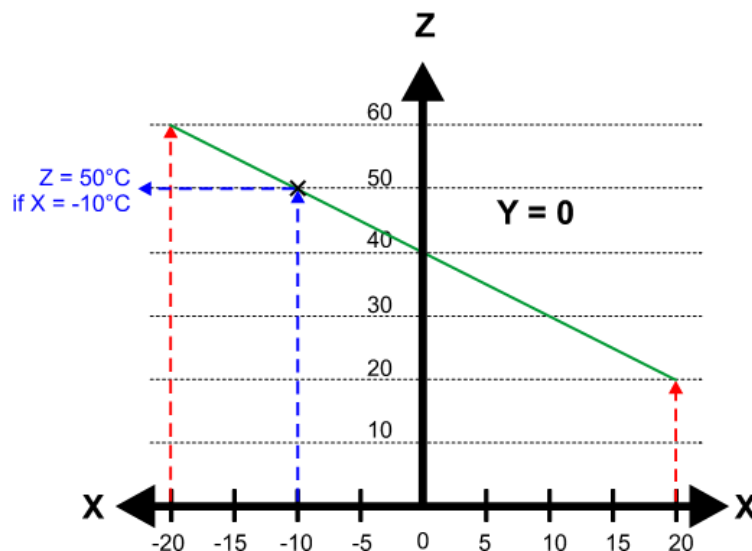

- If only 2 X and 2 Y values are defined, the result is a **flat plane on the 3D plot**.

Example:

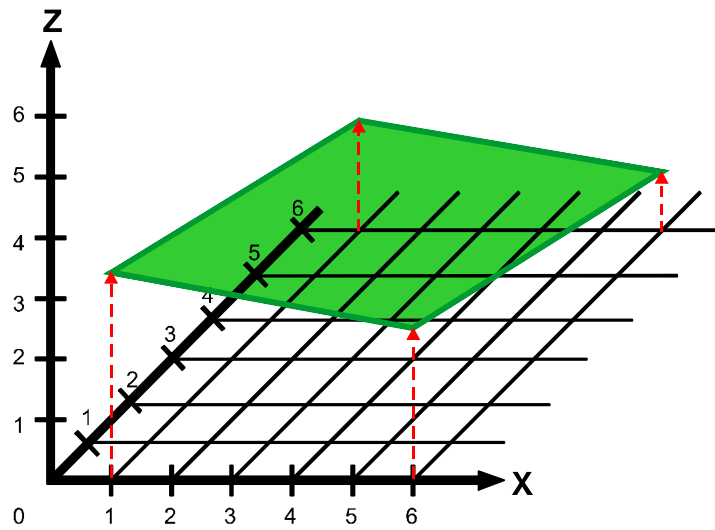

Output variables

Z result

The result of the calculation (analogue value with unit and decimal places of the selected function quantity for Z)

- The intermediate values between the defined points are interpolated by the function.
Plan view of a single element of a 3D plot to explain the interpolation of a point between defined Z values:

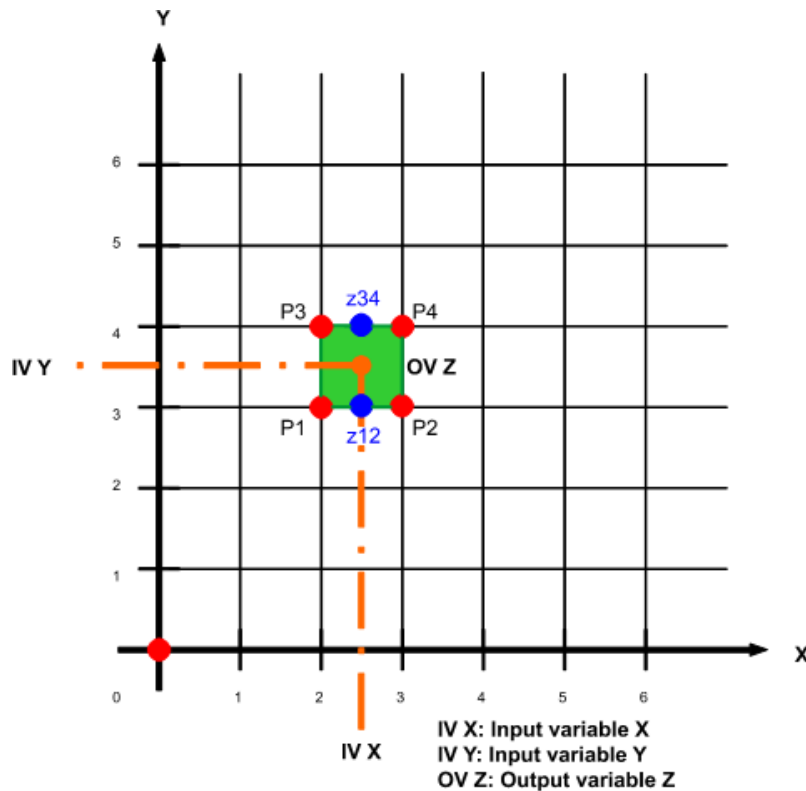

To calculate the Z value, firstly the 2 average values between P1 and P2 (z_{12}) and P3 and P4 (z_{34}) are calculated. Those two average values z_{12} and z_{34} are then averaged in turn and the resulting value is issued as the Z output variable.

- There is no extrapolation of values outside the defined range. If the point lies beyond the defined points, the output will indicate the height of the point where it exited the 3D plot or 2D curve.

Example of two values beyond the defined points

(3D plot for $X = 1$ to $X = 5$ and $Y = 1$ to $Y = 4$):

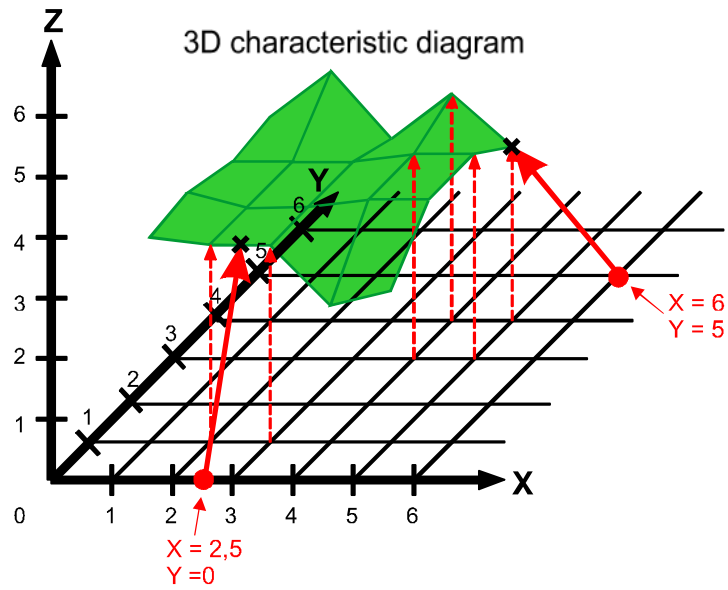

Monitoring function

Function description

The **Monitoring function** allows operating states to be monitored.

It allows observation of a monitored value to detect it exceeding or falling below definable threshold values. This also provides a way of monitoring sensors for short circuits or lead breaks.

The use of two monitored values allows the differential between both values to be observed. This too can be used to monitor sensors for short circuits or lead breaks.

Examples of use in the case of faulty characteristics: triggering of an error message, blocking a faulty function by means of its Enable.

Input variables

Enable	General enabling of the function (digital value ON/OFF)
Monitored value A	Analogue input signal for monitored value A
Monitored value B	Optional: Analogue input signal for monitored value B for differential monitoring
Minimum value	Analogue value specifying the lower threshold of the monitoring range
Maximum value	Analogue value specifying the upper threshold of the monitoring range
<ul style="list-style-type: none"> The monitored values can come from sensors, or from other sources (such as output variables of functions, CAN inputs, etc.). 	

Parameters

Monitoring	Available for selection: <i>Range, Minimum, Maximum</i>
Function quantity	A wide range of function quantities are available, which are applied together with their unit and their decimal places.
Minimum value (shown only for Range and Minimum monitoring) Diff. on Diff. off Verzögerungszeit Minimalwert	Display of the Minimum value input variable Start differential for minimum value Stop differential for minimum value Enter the delay for the minimum value after which a error message should be issued
<ul style="list-style-type: none"> In the Range mode, both the minimum value and the maximum value will be monitored. In the Minimum mode, only the minimum value will be monitored; in the Maximum mode, only the maximum value. If two monitored values are specified in the input variables, the minimum and maximum values refer to the difference between the two monitored values. The delay is applied only for switch-on of the Error output variables, Minimum value error or Maximum value error. When the value returns under/over Diff. off, no delay is applied. 	

Output variables	
Error	Status ON after the delay if the monitored value falls below the minimum value + Diff. on or exceeds the maximum value + Diff. off; selection of an output; active in all modes.
Minimum value error	Status ON after the delay if the value falls below the minimum value + Diff. on; selection of an output; active only in the modes Range and Minimum .
Maximum value error	Status ON after the delay if the value exceeds the maximum value + Diff. on; selection of an output; active only in the modes Range and Maximum .
Monitored value	Display of the relevant monitored value A if only one monitored value is specified, or the A-B differential if two monitored values are used.
Min value ctr	Display of a countdown of the time until error message if monitored value A or the A-B differential has fallen below the minimum value + Diff. on.
Max value ctr	Display of a countdown of the time until error message if monitored value A or the A-B differential has exceeded the maximum value + Diff. on.
<ul style="list-style-type: none"> If the monitored value falls below or exceeds one of the thresholds, the corresponding delay timer will start running. The Error is set to ON if, for the duration of the delay, the monitored value remains below or above the threshold or does not leave the range between Diff. on and Diff. off. 	

Cooling circuit control

Standard diagram

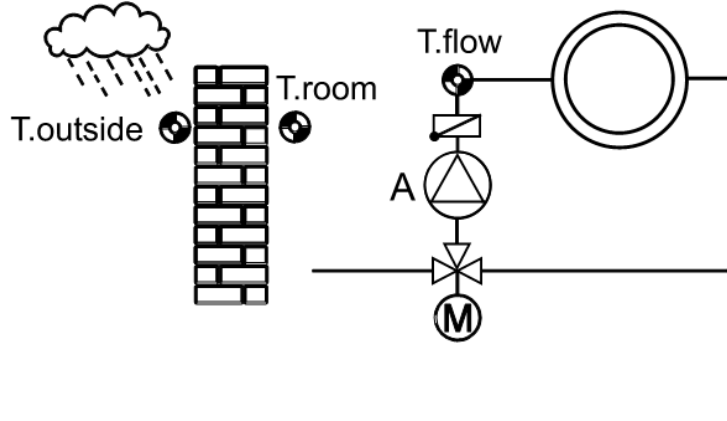

Function description

Mixer control for a cooling circuit based on specified set temperatures and limit temperatures. The time condition status can be used to define the permitted cooling times. Shutdown of the cooling circuit pump is defined by means of parameter settings.

Input variables

Enable	General enabling of the function (digital value ON/OFF)
Enable pump	Enabling of the cooling circuit pump (digital value ON/OFF)
Enable mixer	Enabling the mixer (digital value ON/OFF)
Room temperature	Analogue input signal for the room temperature T.room
Flow temperature	Analogue input signal for the flow temperature T.flow
Outside temperature	Analogue input signal for the outside temperature T.outside
Time condition status	Digital input signal, ON/OFF (e.g. from the Time switch function)
Set room temperature	Analogue value specifying the required set room temperature
Set flow temperature	Analogue value specifying the required set flow temperature
Dew point / flow min.	Analogue value for the dew point temperature
Calendar op. mode	Input signal from the Calendar function for operating mode changeover (see sub-chapter and Calendar function)
Calendar set room t.	Set room temperature when Calendar function is active (see sub-chapter and Calendar function)
Window contact	Digital input signal, ON/OFF
Offset set room temp	Analogue offset value for the set room temperature
Offset set flow temp.	Analogue offset value which is added to the set flow temperature.
<ul style="list-style-type: none"> • Enable cooling circuit = OFF: The entire cooling circuit is deactivated. The set flow temperature is set to 200 °C, the effective set room temperature to 50 °C, all the digital output variables are set to OFF, so the mixer remains unchanged as well. 	

- **Enable pump = Off:** The pump is stopped, the mixer acts according to the setting in the shutdown conditions for Cooling circuit pump = OFF, and the output variables remain as they were with Enable pump ON (except for Clg circ. pump and Mixer).
- With **time condition status OFF**, the cooling circuit is **switched off**, unless a calendar operating mode is active. The set flow temperature is issued as 200 °C and the effective set room temperature as 50 °C.
- The values for set room temperature and set flow temperature can either be defined by the user or can come from other sources (e.g. functions).
- **Dew point / flow min.** can be defined by the user or can come from a RFS-DL humidity sensor, for example. The set flow temperature cannot fall below this value (+ offset values). If the shutdown condition 'if T.flow Act. < min.' is activated, this value (+ offset values) becomes the minimum value for that shutdown condition.
- The cooling circuit can be shut down via the **Window contact** input variable. A (digital) ON signal leaves the cooling circuit in the current operating mode; an OFF signal activates shutdown.

Parameter

Mixer Control speed	Matching of the control speed to the cooling circuit (setting range 20 % - 500 %) The percentage changes the length of the pulses (but not the time between them), which are emitted to open/close the mixer.
Average	Sub-menu: Averaging of the outside temperature for pump shutdown (see Average sub-chapter)
Derivative time	Utilises the Time switch function to shift the switching point of cooling operation according to the outside temperature (see Derivative time sub-chapter)
Shutdown conditions	Sub-menu: Pump shutdown and mixer conditions (see Shutdown conditions sub-chapter)
Offset flow dew pt	Entry of an offset value for the Dew point / flow min. input variable

Parameters in the Average sub-menu

AVERAGE (outside temperature)

When outside temperatures form the basis of pump shutdown, fluctuations in those temperatures can sometimes be undesirable. The option of adjusting the outside temperature is therefore available for the purposes of pump shutdown.

For outside temperature	Calculation of the adjusted outside temperature
Filter time	Enter the filter time (the averaging time)
Average OT for shutdown	Result of the calculation (T.outside AVo)

DERIVATIVE TIME

Fixed heating times may cause cooling to start too early or too late, depending on the outside temperature. The derivative time shifts the switching point subject to outside temperature. The time entered is in reference to an outside temperature of +30 °C and is zero at +20 °C. For example, if the derivative time is 1 hour and the outside temperature is 25 °C, the switching time is brought forward by 30 minutes. The derivative time is only effective if an outside temperature sensor is defined in the input variables. The effective derivative time according to the average outside temperature is an output variable and can be adopted by the Time switch function.

Parameter Submenü Abschaltbedingungen

SHUTDOWN CONDITIONS and mixer action

The controller allows the following shutdown conditions for the cooling circuit pump:

if T.room Act. < set Diff. on Diff. off	Shutdown when the required room temperature (+ offset value) is reached Start differential for the effective set room temperature Stop differential for the effective set room temperature
if T.flow Act. < min. Diff. on Diff. off	Shut down if the flow temperature falls below the minimum value Dew point / flow min. + Offset flow dew pt Start differential for minimum value Stop differential for minimum value
if T.outside Aver.off < min. T.outside min. Diff. on Diff. off	Shutdown if the average outside temperature T.outside AVo falls below the adjustable value T.outside min. Required threshold value Start differential for T.outside min. Stop differential for T.outside min.
if cooling circ pump = off Mixer	Mixer action after shutdown of the pump (unless Enable cooling circuit = Off): Available for selection: Close, Open, Unchanged, (continue to) Regulate
if enable mixer = off Mixer	Mixer action when Enable mixer = Off: Available for selection: Close, Open, Unchanged
<ul style="list-style-type: none"> None of the parameter values have an adjustable hysteresis. The switching thresholds are each divided into a start differential and a stop differential. 	

CALENDAR

The Calendar op. mode input variable selects the operating mode of a Calendar function.

In the Calendar set room t input variable, the set value (=set room temperature) 1, 2 or 3 assigned to the operating mode must be specified. However, any other source is permitted as well (e.g. a calendar set room temperature from another controller via the CAN network). This set value takes priority over the Set room temperature input variable.

If no calendar set temperature is defined (unused), the calendar operating mode will have no effect on the function.

If two or more calendar operating modes are active simultaneously, the operating mode with the highest priority (see Calendar function) is applied together with the corresponding set value.

If no calendar operating mode is active (Inactive (0) is displayed in the input variables), the calendar set room temperature defined in the Calendar function for Inactive will be displayed in the input variables. That value will not be applied in the cooling circuit function, however.

Output variables	
Set flow temperature	Issue of the current set flow temperature
Effective set room temp.	Issue of the effective (= current) set room temperature
Clg circ. pump	Cooling circuit pump status ON/OFF; selection of the output
Open/close mixer	Mixer status OPEN/OFF/CLOSE; selection of the switching outputs (dual output)
Mixer 0 - 100 %	A percentage value to one decimal place, for control of a mixer with 0-10 V input via an analogue output
Derivative time	The effective derivative time subject to outside temperature
T.room > set	Status OFF if the shutdown condition Act. T.room > set is met.
T.outside > min.	Status OFF if the shutdown condition T.outside AVo < min. is met.
T.flow > min.	Status OFF if the shutdown condition Act. T.flow < min. is met.
Remaining runtime ctr	Display of the remaining mixer runtime
Mixer open	Status ON when the mixer is fully open (after expiry of remaining runtime)
Mixer closed	Status ON when the mixer is fully closed (after expiry of remaining runtime)
Average OT for shut-down	Calculated adjusted outside temperature, utilised for the pump shutdown conditions (see Average sub-chapter)
<ul style="list-style-type: none"> • If the cooling circuit pump is switched off by the time condition status, then the set flow temperature is issued as +200 °C + Offset and the effective set room temperature as +50 °C. • If the cooling circuit pump is switched off by means of the Window contact or a Shutdown condition, only the set flow temperature will be issued set to +200 °C + Offset. • Mixer 0 – 100 %: Scaling of the analogue output: 0 = 0.00 V / 1000 = 10.00 V • The remaining runtime counts down from 20 minutes when a dual output (mixer drive) is linked to the Open/close mixer output variable. If a dual output is not linked, the remaining runtime counts down from 2 minutes. • If the runtime limit was deactivated in the mixer output settings, the remaining runtime only counts down to 10 seconds and output pair control is not terminated. • The remaining runtime (20 minutes) is reloaded if the mixer output is in manual mode, is switched by a message (to dominant ON or OFF), changes its direction of control from OPEN to CLOSE or vice-versa, or if Enable is switched from OFF to ON. • Mixer open / closed: If the runtime limit was deactivated, the mixers are still displayed as open or closed after the remaining runtime is complete. • The output variables that refer to shutdown conditions are always in status ON if the applicable shutdown condition has not been activated. 	

Charging pump

Standard diagram

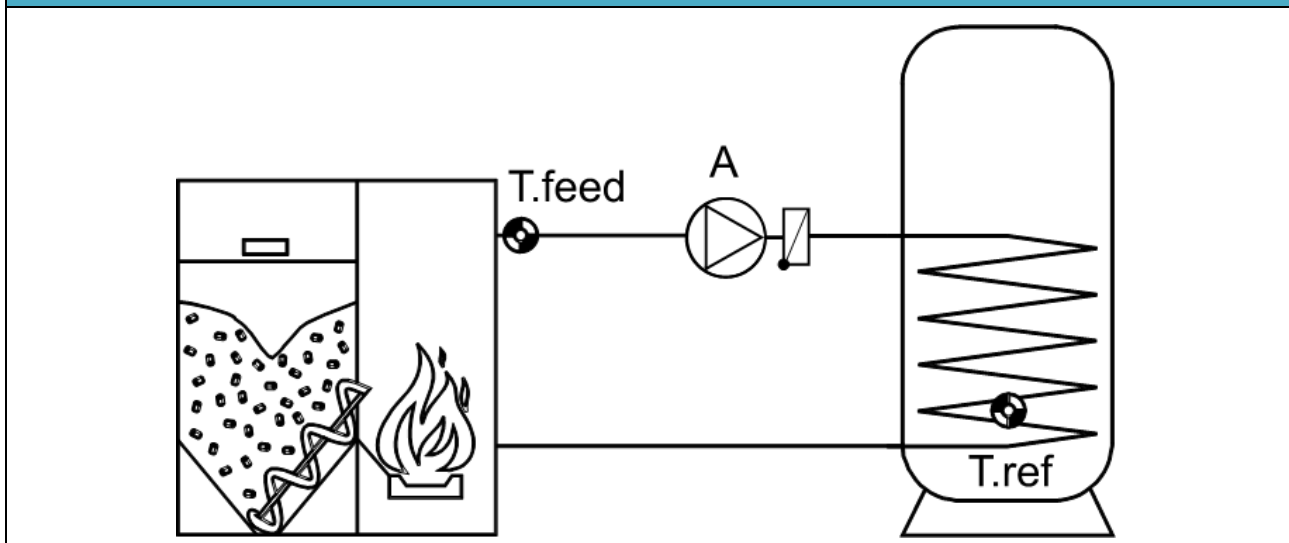

Function description

Charging pump A is switched on if the feed temperature T.feed is above the minimum temperature and is higher than the reference temperature T.ref by a given differential. In addition, T.ref must not have reached its maximum limit yet.

Eingangsvariablen

Enable	General enabling of the function (digital value ON/OFF)
Feed temperature	Analogue input signal for the feed temperature
Reference temperature	Analogue input signal for the reference temperature
Minimum feed temp.	Analogue value specifying the minimum temperature at the feeding appliance (e.g. boiler)
Max. reference temp.	Analogue value specifying the maximum reference temperature (e.g. cylinder)

- The minimum temperature at the feeding appliance and the maximum reference temperature are normally defined by the user. These two thresholds are defined as input variables to maximize the programmer's linking options.

Example: Link with burner demand for DHW heating. The **DHW demand** supplies the effective set temperature for the cylinder as an output variable. That allows the set temperature to be used as the maximum temperature for the Charging pump function as well.

Parameters	
Feed temperature T.feed min. Diff. on Diff. off	Display: Start threshold at the T.feed sensor (thermal energy feed) Start differential for T.feed min. Stop differential for T.feed min.
Reference temperature T.ref. max. Diff. on Diff. off	Display: Stop threshold (cylinder limit) Start differential for T.ref. max. Stop differential for T.ref. max.
Differential feed – ref. Diff. on Diff. off	Start differential, feed - reference Stop differential, feed - reference
<ul style="list-style-type: none"> Neither thermostat threshold has a hysteresis, but instead start and stop differentials for the adjustable threshold value. Example: T.feed min. = 60°C Diff. on = 5,0K Diff. off = 1,0K ⇒ If the T.feed temperature exceeds 65 °C (= 60 °C + 5 K), the output becomes active, whereas shutdown occurs if the temperature drops below 61 °C (= 60 °C + 1 K). In the case of the minimum feed temperature T.feed min., Diff. on must always be greater than Diff. off, whereas in the case of the maximum reference temperature T.ref. max., Diff. on must always be less than Diff. off. 	

Output variables	
Charging pump	Charging pump status ON/OFF; selection of the output
T.feed > T.feed min.	Status ON if the feed temperature is higher than the minimum threshold
T.ref. < T.ref. max.	Status ON if the reference temperature is lower than the maximum threshold
T.feed > T.ref.	Status ON if the feed temperature is higher than the reference temperature + Diff. on/Diff. off

Pasteurisation function

Function description	
<p>The function monitors the temperature in cylinders to prevent the growth of Legionella bacteria. The function starts if, during the interval time, the set temperature is not reached at the monitored sensor for the duration of the hold time. Once the set temperature is reached, the function's output status remains ON for the duration of the hold time. During the hold time, the sensor temperature is kept above the set temperature. This procedure is also called disinfection.</p> <p>The time interval restarts if, during the time interval, the set temperature is exceeded for the duration of the hold time (e.g. by the action of the solar thermal system).</p> <p>There is also the option of starting the function by means of an ON pulse or from the parameter menu.</p>	

Input variables	
Enable	General enabling of the function (digital value ON/OFF)
DHW temperature	Analogue input signal for the domestic hot water temperature
Set temperature	Analogue value specifying the set domestic hot water temperature for pasteurisation
Decontamination	Digital input signal, ON/OFF, for an immediate start of the function
<ul style="list-style-type: none"> The Decontamination input variable can come from a pushbutton, or from another function. An ON pulse will cause the hold time to start once the set temperature + Diff off is exceeded. The set temperature must then be maintained continuously for the duration of the hold time. The function will not start if the sensor captures a temperature above the set temperature at the start and the hold time has already elapsed. 	

Parameters	
Interval time	Enter the required interval time (minimum time: 1 hour) The function starts if, during the interval time , the set temperature is not exceeded at the specified sensor for the duration of the hold time .
Hold time	Enter the required hold time (minimum time: 1 minute)
Generator output	Enter the required heat generator output (e.g. for a modulating burner) when the function is active
Diff. on Diff. off	Start differential for the set DHW temperature Stop differential for the set DHW temperature
Start decontamination	Tapping this button starts the function under the same conditions as when started by means of the "Decontamination" input variable.
<ul style="list-style-type: none"> For the hold time to start during pasteurisation, the DHW temperature must exceed the set temperature threshold + Diff. off. The DHW temperature must not fall below the set temperature threshold + Diff. on (= hysteresis) for the duration of the hold time. 	

Output variables	
Decontaminate	Function status ON/OFF; selection of the output
Generator output	The output of the heat generator as % to one decimal place; selection of the analogue output (0-10 V or PWM)
Hold timer	Display of a countdown of the hold time
Effective set temperature	Display of the current set temperature during pasteurisation. If pasteurisation is not carried out, 5 °C is displayed.
<ul style="list-style-type: none"> • The hold timer counts down during the interval time once the set temperature + Diff. on is exceeded at the sensor. If the DHW temperature falls below the set temperature + Diff. on while the hold time is counting down, the hold time countdown will be restarted once the set temperature + Diff. on is reached again. • If the DHW temperature falls below the set temperature + Diff. on during pasteurisation, the hold time countdown will be restarted once the set temperature + Diff. off is reached again. This ensures that the sensor maintains the required temperature continuously. • Generator output: Scaling of the analogue output: 0 = 0.00 V / 1000 = 10.00 V 	

Output control

Standard diagram

See **Energy manager** function description.

Function description

The output control function is used to control loads (e.g. **EHS** immersion heater or **LST** output controller) according to the specifications of the **energy manager** function, or by means of forced operation.

When used with an **energy manager** function, output control is specified in this function's parameters as an **involved function**. Up to 12 output controls can be managed by one energy manager.

For use without an **energy manager** function, the **forced operation** and **forced operation output** input variables are used. The output can then be specified manually or by any other control event.

With the **Participating CORA device** parameter, **Output control** makes it possible to control a device using the "CORA" wireless system. Further information on this wireless system can be found in the installation instructions for the corresponding devices.

Input variables

Enable	General enabling of the function (digital value ON/OFF)
Minimum output	Upper and lower limits of the output to be consumed
Maximum output	
Start differential	<p>The consumer is not activated until the minimum output + start differential is reached.</p> <p>The consumer is deactivated again when the output falls below minimum output.</p> <p>Operation proceeds, taking account of the minimum runtime, stop delay and blocking time parameters.</p>
Forced operation	The consumer is enabled without taking account of the specifications of the energy manager (digital value ON/OFF).
Forced operation output	Set output when forced operation is active.
<ul style="list-style-type: none"> When used in conjunction with an energy manager, the set output comes from that function; otherwise from the forced operation output input variable. <ul style="list-style-type: none"> Forced operation takes precedence over the specifications of the energy manager function. The value of the maximum output input variable should not exceed the maximum output of the consumer (e.g. 3 kW for an EHS immersion heater). 	

Parameters	
Cycle time	Specifies the cycle in which the calculation of the output control should occur. Delayed responses of consumers can be compensated. This parameter also affects the higher ranking energy manager.
Minimum runtime	If the consumer is activated, it may only be deactivated again after this time has elapsed.
Run-on time	If the consumer is to be deactivated, it continues to run for this time until it is actually deactivated.
Pause time	If the consumer is deactivated, it may only be reactivated after this time has elapsed.
Involved network node (display only for devices with x2 wireless)	If the function is to control a device via x2 wireless, this is defined here. A link must first be established with the device in the Network node menu.
<ul style="list-style-type: none"> • Cycle time: If the values of the output control are transmitted, for example, via the CAN bus to a controller, which switches the consumer, the calculation of the function is much quicker than values can be transferred via the CAN bus. This can have a negative impact on delayed responses of the control characteristics (system starts to oscillate). The cycle time should be matched to the transfer time of the bus. • The minimum runtime, run-on time and pause time parameters also apply to forced operation. 	

Output variables	
Correcting variable	Selection of an analogue output for consumer output modulation Displays the percentage of modulated output specified for the selected analogue output (0-100 %) <ul style="list-style-type: none"> • 0 % corresponds to 0 W • 100 % corresponds to the set maximum output
Status	Selection of the switching output of the consumer Display ON/OFF
Effective set output	Output to be consumed at the moment (specified by the energy manager function)
Minimum runtime meter	Meter for the remaining minimum runtime (see Parameters)
Run-on time meter	Meter for the remaining run-on time (see Parameters)
Pause time meter	Meter for the remaining pause time (see Parameters)
Cycle timer	Meter for the remaining cycle time (see Parameters)
<ul style="list-style-type: none"> • The effective set output and the meters are for display only. 	

Example: Actuation of an EHS-R by PWM

Output control function	
Minimum output parameter	0,05 kW
Maximum output parameter	3,00 kW
Start differential parameter	0,01 kW

Connected analogue output	
Input value 1	0
Target value 1	10,0 %
Input value 2	1000
Target value 2	90,0 %

Logic function

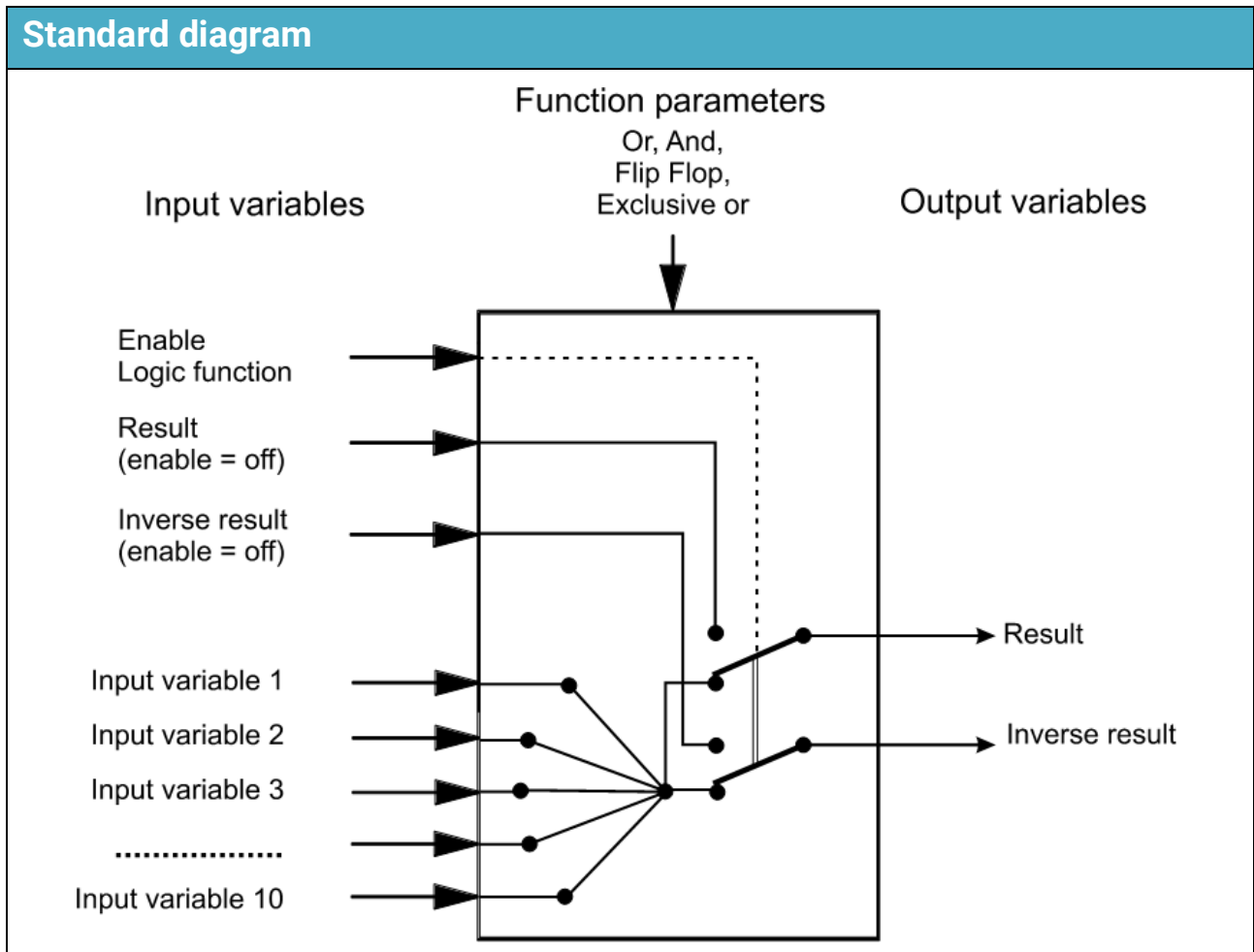

Function description

The Logic function generates a digital result from up to 10 digital inputs by applying the logic parameters.

Eingangsvariablen

Enable	General enabling of the function (digital value ON/OFF)
Result (enable = off)	Digital value for the result output variable when Enable is OFF
Inv. result (enable = off)	Digital value for the inverse result output variable when Enable is OFF
Input variable 1 – (maximum) 10	Digital values, ON/OFF, used to produce the result subject to mode. The number of input variables is set in the Parameters menu.

- Input variables that are not used must be set to *unused*.
- If the Logic function is blocked (Enable = Off), it issues a value which is either defined by the user with Result (enable = off) or Inv. result (enable = off) or which comes from a specific source. Enable can therefore be used to switch between digital values.

Parameter	
Mode	Available for selection: Or, And, Flip flop, Exclusive or (for explanation see below)
No. of inputs	Enter the number of input variables
Variable 1- (maximum) 10	Display of the variables
<ul style="list-style-type: none"> The mode is applied to the input variables to generate the following result as the output variable: <ul style="list-style-type: none"> Or: Result = ON if at least one input is ON. And: Result = ON if all linked inputs are ON. Flip flop: The flip flop function (also called a holding circuit) operates according to the following formula: <ul style="list-style-type: none"> Result = permanently ON if at least one of the inputs I1, I3, I5, I7, I9 has been set to ON (set holding circuit), even if the input drops out again afterwards (set pulse). Result = permanently OFF if at least one of the inputs I2, I4, I6, I8, I10 has been set to ON (delete holding circuit). This delete command is dominant. Therefore switch-on is not possible when a delete input is ON (reset pulse). Exclusive or (also termed XOR) Result = ON if an uneven number of input variables are set to ON. Example with two input variables: The result is ON if one of the two input variables is set to ON. If both are set to ON or OFF, the result is OFF. Another example with five input variables: The input variables 1, 2 and 3 are set to ON, 4 and 5 to OFF. The result is ON because three input variables (= uneven number) are set to OFF. Unused inputs are ignored in all modes. 	

Output variables	
Result	Issue of the result: ON/OFF; selection of the output
Inverse result	Issue of the inverse result: ON/OFF; selection of the output

Value table based on two inputs + Enable:**And**

Enable	Input 1	Input 2	Output	Inv. output	Comments
ON	OFF	OFF	OFF	ON	
ON	ON	OFF	OFF	ON	
ON	OFF	ON	OFF	ON	
ON	ON	ON	ON	OFF	
OFF	X	X	1)	1)	

Or

Enable	Input 1	Input 2	Output	Inv. output	Comments
ON	OFF	OFF	OFF	ON	
ON	ON	OFF	ON	OFF	
ON	OFF	ON	ON	OFF	
ON	ON	ON	ON	OFF	
OFF	X	X	1)	1)	

Flip flop

Enable	Input 1	Input 2	Output	Inv. output	Comments
ON	OFF	OFF	OFF	ON	Previous state
ON	ON	OFF	ON	OFF	I1 is saved
ON	OFF	OFF	ON	OFF	Previous state
ON	OFF	ON	OFF	ON	I2 deletes output
ON	ON	ON	OFF	ON	I2 dominant
OFF	X	X	1)	1)	

Exclusive or (example with three inputs)

Enable	I 1	I 2	I 3	Output	Inv. output	Comments
ON	OFF	OFF	OFF	OFF	ON	
ON	ON	OFF	OFF	ON	OFF	Uneven number ON
ON	ON	ON	OFF	OFF	ON	
ON	ON	ON	ON	ON	OFF	Uneven number ON
ON	OFF	ON	ON	OFF	ON	
ON	OFF	ON	OFF	ON	OFF	Uneven number ON
ON	ON	OFF	ON	OFF	ON	
ON	OFF	OFF	ON	ON	OFF	Uneven number ON
OFF	X	X	X	1)	1)	

1) If **Enable** is **OFF**, the function issue will be the values either defined by the user in Result (enable = off) or Inv. result (enable = off) or which come from a specific source.

Mathematics function

Function description	
The Mathematics function applies various mathematical calculations and functions to four values of analogue input variables to produce four different calculated results. The results can be assigned to selected function quantities.	

Input variables	
Enable	General enabling of the function (digital value ON/OFF)
Result (enable = off)	Analogue value for the Result output variable when Enable is OFF
Result ABCD (enable = off)	Analogue value for the Result ABCD output variable when Enable is OFF
Result AB (enable = off)	Analogue value for the Result AB output variable when Enable is OFF
Result CD (enable = off)	Analogue value for the Result CD output variable when Enable is OFF
Input variable A - D	Analogue values for the mathematical calculations (to five decimal places)
<ul style="list-style-type: none"> • If the function is blocked (Enable = Off), it issues values which are either defined by the user with Result (enable = off) or which come from a specific source. Enable can therefore be used to switch between analogue values. As the function produces four different results, there are also four input variables for those results when Enable is OFF. • If the source of an input variable is set to <i>User</i>, the user can specify an adjustable numeric value. • As the mathematical calculations can be carried out either using all four input variables or using two of them, appropriate selection of the unused input variables is important for a correct result. 	

Parameters

Function quantity Selection of the required function quantity. A wide range of function quantities are available, which are applied together with their unit and their decimal places.

- As it truncates (cuts off) the decimal places, the dimensionless function quantity (= without decimal places) is usually inappropriate when functions are used. For precise calculations, dimensionless function quantities with decimal places are available (e.g. Dimensionless (.5) with five decimal places).

View in TAPPS2

Formula: ((A x B) x (C x D))	
Function	
Input variable A	1,00000
Operator 1	x
Input variable B	1,00000
Operator 2	x
Input variable C	1,00000
Operator 3	x
Input variable D	1,00000

View on display:

[] ((A [] B) [] (C [] D))

Function	<input type="text"/>	Operator 2	<input type="text" value="x"/>
Input variable A	1.00000	Input variable C	1.00000
Operator 1	<input type="text" value="x"/>	Operator 3	<input type="text" value="x"/>
Input variable B	1.00000	Input variable D	1.00000

The arithmetic operation is performed according to the following formula:

$$\boxed{\text{Function}} \left((A \boxed{\text{Operator 1}} B) \boxed{\text{Operator 2}} (C \boxed{\text{Operator 3}} D) \right)$$

- The first field **Function** can remain empty, in which case it has no effect on the arithmetic operation. In this field, a function can be selected which will be applied to the result of the arithmetic calculation that follows:
 - Absolute value **abs**
 - Square root **sqrt**
 - Trigonometric functions **sin, cos, tan**
 - Inverse trigonometric functions **arcsin, arccos, arctan**
 - Hyperbolic functions **sinh, cosh, tanh**
 - Exponential function e^x **exp**
 - Natural and common logarithms **ln** and **log**
- The fields marked Operator 1 - 3 are for selecting the arithmetic operation::
 - Addition **+**
 - Subtraction **-**
 - Multiplication **x**
 - Division **:**
 - Modulo **%** (remainder from a division)
 - Exponentiation **^**
- The brackets must be observed in accordance with mathematical rules.

Output variables	
Result	The result of the calculation including any function calculation
Result ABCD	The result of the calculation for all four variables A, B, C and D without any function calculation
Result AB	The result of the calculation for the two variables A and B without any function calculation
Result CD	The result of the calculation for the two variables C and D without any function calculation
<ul style="list-style-type: none"> • The results are produced with the selected function quantity (unit) and the decimal places specified by it, and can be used as input variables for other functions, for example. • The results are not mathematically rounded. The decimal places not displayed are discarded. • If the Dimensionless (.5) function quantity is used in the calculation, the result will have five decimal places. The Scaling function can then be used to convert that result into a value with any other function quantity, with truncation removing any decimal places that are not required. 	

Message

Function description

The Message function permits messages (errors, faults, etc.) to be generated in line with definable events if those events occur for **longer than the defined delay**.

A pop-up window (**message window**) can be displayed on screen when a message is issued. A **warning symbol** will appear in the upper part of the screen and in the message's function status. The LED indicator on the controller can change its status (color, flashing) (adjustable setting). In addition, output variables provide switching signals as long as the message is current.

Input variables

Enable	General enabling of the function (digital value ON/OFF)
Activate message	Digital input signal, ON/OFF, from the triggering event
Delete message	Digital input signal, ON/OFF, to delete the message
Warning tone off	Digital input signal, ON/OFF, to switch off the warning tone
<ul style="list-style-type: none"> Every message function has a deletion input which can be assigned to a reset or acknowledgement key via a digital input, or which allows an automatic reset by another function. User / ON causes automatic deletion of the message as soon as the cause of the message ceases to exist. However, the message window will still remain visible unless Hide messages is tapped. 	

Parameters

Type	Available for selection: Error, Fault, Warning, Message
Priority	Enter the priority (1 – 10)
Delay	Enter the delay for triggering the message
Pop-up window	Available for selection: Yes / No If the pop-up window is switched off, the warning symbol will no longer be displayed.
Status LED	Define the status of the LED indicator on the controller Available for selection: <i>unchanged, green, orange, red, flashing green, flashing orange, flashing red</i>
Warning tone	Available for selection: Yes / No
Reset dominant automatically	Available for selection: Yes / No. If Yes is selected, outputs switched to dominant will be released again once the message cause ceases to exist .
Display on other devices	Entry of the node number of a different X2 device (UVR16x2 with display, CAN-MTx2) on which the message should be displayed
Warning tone off Delete message Reset fault	Depending on the message type and the settings, these buttons may be used to switch off the warning tone, to delete the message (after eliminating its cause) and to reset the fault.

- If a message is displayed on a different device, then the settings for pop-up windows, warning tones and status LEDs will also apply on this device.
The buttons "Delete message", "Reset fault" and "Warning tone off" have the same effect as on the controller itself.
- A **warning tone** can be activated. This can be switched off via the digital input variable "Warning tone off", via the message window using "**Hide message**" or "**Warning tone off**", or manually via the parameter menu.
- **Priority:** If multiple messages are active simultaneously, the following sequence applies for the pop-up window display and the LED status:

Message type	Priority		Display
Error	1	Highest priority 	Red pop-up window
		
	10		
Fault	1		Red pop-up window
		
	10		
Warning	1		Orange pop-up window
		
	10		
Message	1	Lowest priority	Yellow pop-up window
		
	10		

Output variables

Message active	Status ON as long as the message is active (not deleted), even if the cause of the message no longer exists.
Dominant on	Status ON as long as the message is active. Selection of switching outputs which are switched to dominant on when the message is triggered, even if they were set to Manual/OFF or Auto/OFF.
Dominant off	Status ON as long as the message is active. Selection of switching outputs which are switched to dominant off when the message is triggered, even if they were set to Manual/ON or Auto/ON.
Dominant on (expert)	Like Dominant on but the output can be switched manually in Expert mode .
Dominant off (expert)	Like Dominant off but the output can be switched manually in Expert mode .
Dominant on (technician)	Like Dominant on but the output can be switched manually in Technician mode .
Dominant off (technician)	Like Dominant off but the output can be switched manually in Technician and Expert mode .
Reset fault	Status ON for three seconds if the Fault message type was selected and Reset fault has been tapped.
Warning tone	Status ON as long as a message is active, Warning tone yes is set in its parameters, and the warning tone has not yet been switched off.
Activation date	Date message was last activated
Activation time	Time message was last activated
<ul style="list-style-type: none"> • When outputs are switched via dominant commands, this generally overrides any control signals from simple assignments and the manual mode as well. If two different dominant signals (ON and OFF) are applied to an output simultaneously, the dominant OFF signal has priority. • Outputs that are switched to dominant ON or dominant OFF are shown with a red border around them in the output overview along the top edge of the screen. 	

- If the controller is in Expert mode **at the time of the message** and the output for Dominant on (**expert**) is currently set to Manual OFF, **it will remain switched off**. The same principle applies accordingly to the outputs for Dominant off (**expert**) and to the Dominant on/off (technician) outputs.
- The message window for an active message will be hidden when **Hide messages** is tapped. This will also switch off an activated warning tone. If the message has not yet been deleted, tapping the warning symbol causes the message window to reappear.
- The message can be **deleted** in the **message window** and the **parameter menu**. The message cannot be deleted until the message cause ceases to exist.
- The **warning tone** can be switched off in the message window or by means of **Hide messages**.
- **Fault** message type **only**: A specific **Reset fault** output variable is available in order to reset external devices. **Reset fault** (in the **message window** or in the **parameter menu**) will generate an ON pulse three seconds long. Reset fault can be actuated multiple times as long as the message cause continues to exist. Once the message cause ceases to exist, **Reset fault** is only possible once more; the message itself is then deleted straight away.
- If the message is **deleted** by means of an input variable or in the message window or manually from the parameter menu, this output variable will not be activated.
- In the "**Messages**" menu, all messages are displayed with the message time.

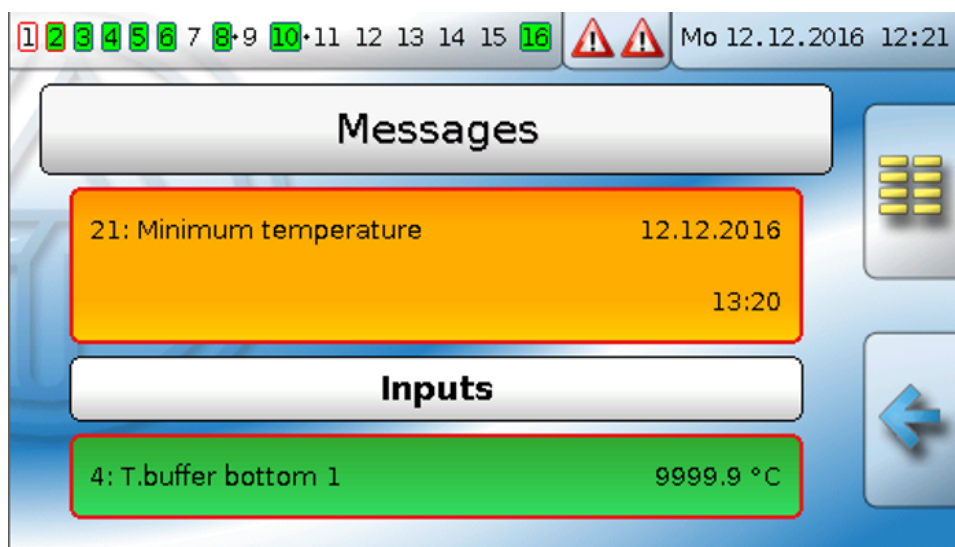

- Outputs switched **dominant** will also be marked with a **red border** in the **Outputs** menu:

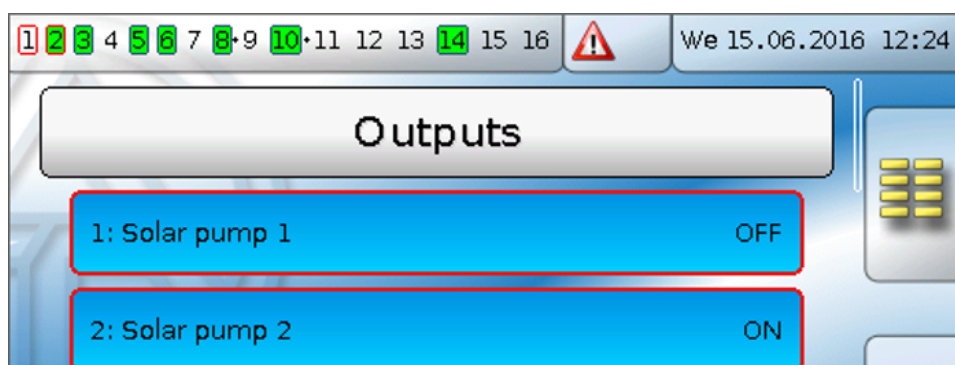

Example: Error message type, output 1 dominant OFF, output 2 dominant ON, warning tone activated, output for warning tone: output 12.

After the message has been triggered and the cause of the fault has ceased to exist, the following display appears (**red**):

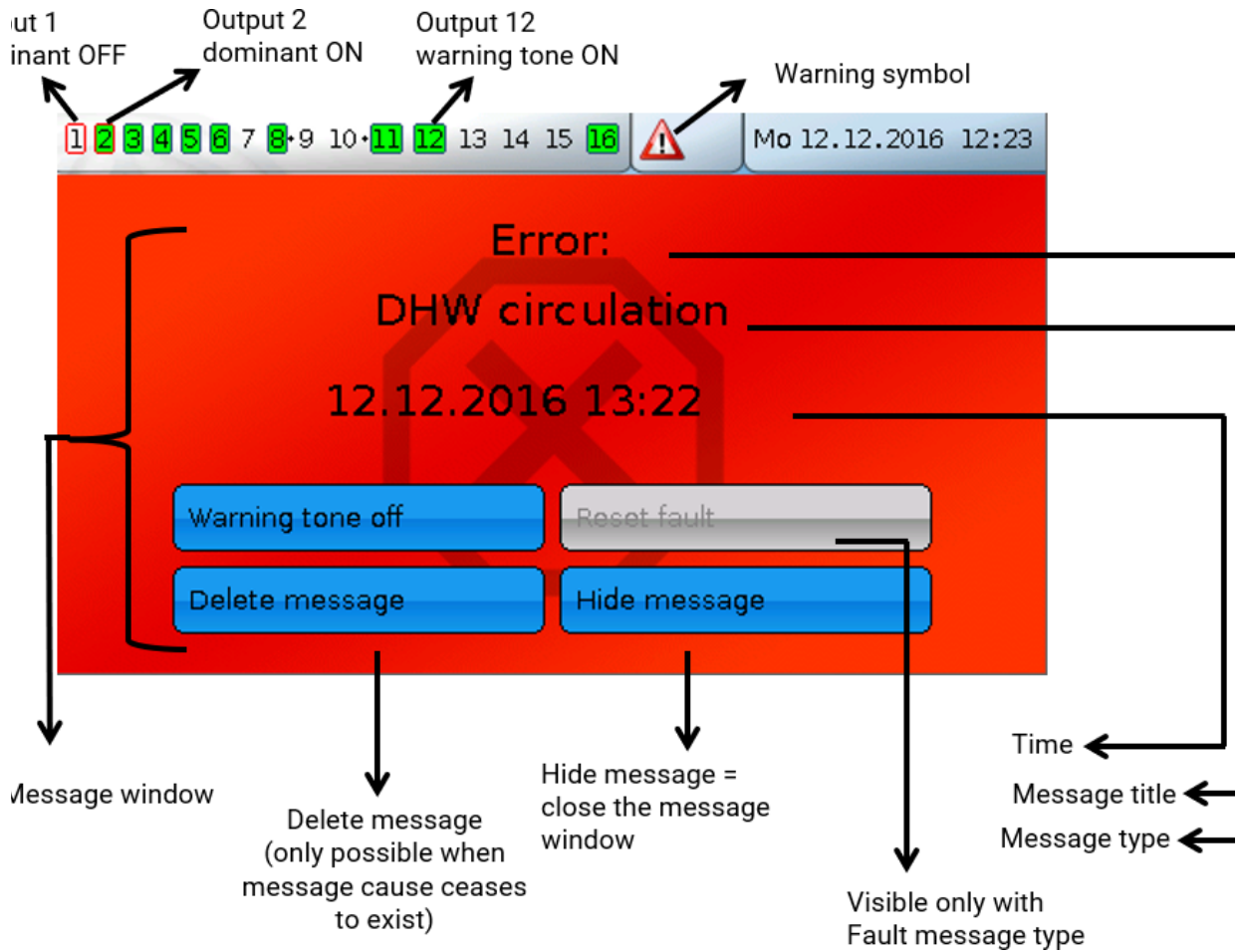

If the message window has been hidden, it can be redisplayed by tapping the **warning symbol** in the status line.

Example: Fault message type, output 1 dominant OFF, output 2 dominant ON, warning tone activated, output for warning tone: output 12.

After the message has been triggered and the cause of the fault has ceased to exist, the following display appears (**red**):

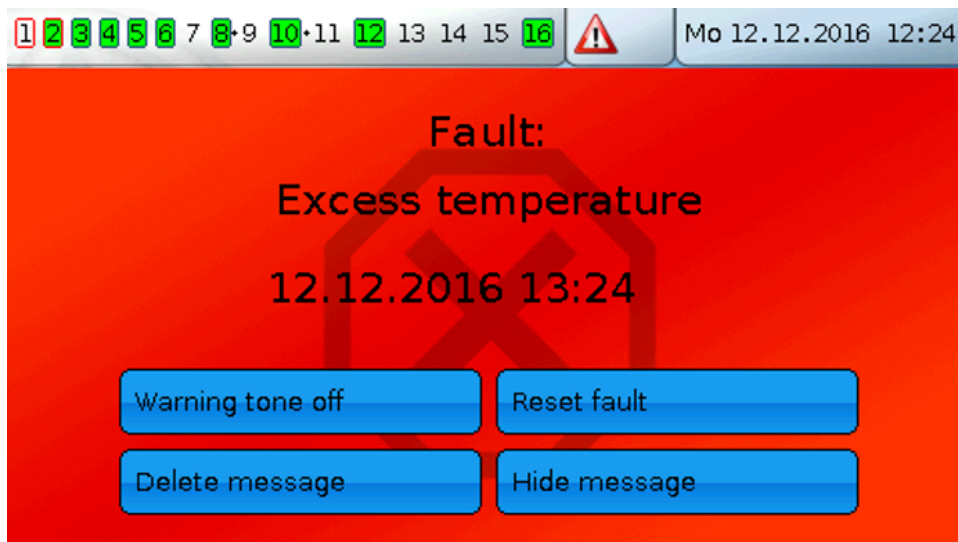

Example: Warning message type, output 1 dominant OFF, output 2 dominant ON, warning tone activated, output for warning tone: output 12.

After the message has been triggered, the following display appears (**orange**):

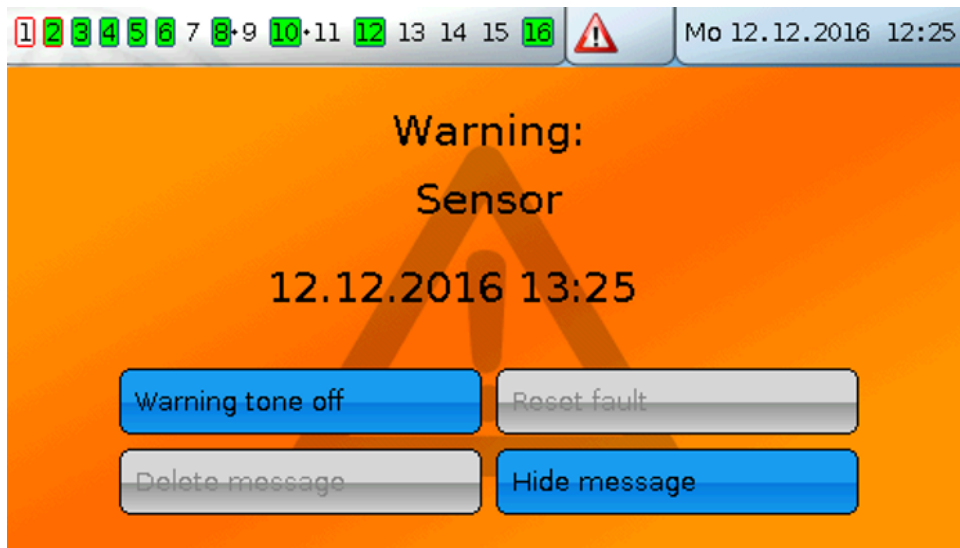

Example: Message message type, output 1 dominant OFF, output 2 dominant ON, warning tone activated, output for warning tone: output 12.

After the message has been triggered, the following display appears (**yellow**):



- Depending on the setting in the x2 device, messages from other x2 devices can also be displayed with a pop-up window, a changed status LED and/or a warning tone. The pop-up window works in the same way and affects the message on the other x2 device.
- If one output in an output pair is activated as **dominant**, the other output in the output pair will be switched off if it was currently switched on by a function.
If both outputs in an output pair are activated as **dominant** by one or more messages simultaneously, only the output with the higher number (CLOSE command) will be activated.

Mixer control

Standard diagram

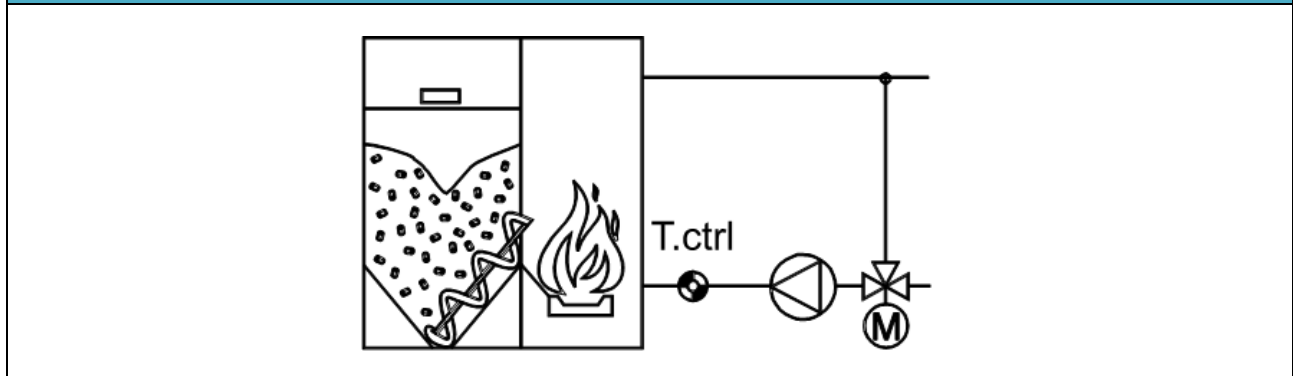

Function description

This function allows a mixer to be constantly controlled to a set value. The function can control a three-position actuator or an actuator with 0-10 V input (continuous analogue signal).

Input variables

Enable	General enabling of the function (digital value ON/OFF)
Actual value	Analogue input signal for the current actual value T.ctrl
Set value	Analogue value specifying the set value for control
Offset set value	Analogue value specifying an offset for the set value
Initialisation run	Digital input signal, ON/OFF, to start an initialisation run

- The set value and the offset value can be fixed values (source: user) or they can come from another source as variable values.
- **Initialisation run:** If the "Actual value" input variable is **unused**, then the value of input variables "Set value + Offset set value" is issued in % as the **set value for control**. Output variable "mixer 0 - 100 %" is aligned with this value. This allows a precise set position in % to be specified for a mixer **with 0 - 10 V input**. The mixer can be set to an end position by a start pulse at the input variables.

Parameters

Mode	Available for selection: <i>Standard</i> or <i>Inverse</i>
Set val for ctrl T.ctrl set	Display: Specified set value (+ offset value)
if enable = off Mixer position	Mixer action when Enable mixer = Off: Available for selection: <i>Open, Close, Unchanged</i>
Mixer Control speed (only visible if the "Actual value" input variable is used)	Matching the control speed to the control loop (setting range 20.0 % - 500.0 %) The percentage changes the length of the pulses (but not the time between them), which are emitted to open/close the mixer.

Initialisation run Mixer position (only visible if the "Actual value" input variable is unused)	For the initialisation run , you can specify whether the mixer first runs to the OPEN or CLOSED position, or regulates immediately (select "Unchanged") Selections: open, closed, unchanged
<ul style="list-style-type: none"> In addition to the Standard mixer mode, Inverse mode is also available. With Inverse the mixer opens as the temperature rises. In inverse mode, the mixer also operates inversely when enable = off, i.e. the mixer opens when close is selected. 	

Output variables	
Set value for control	Set value calculated by the controller from set value + offset value
Open/close mixer	Mixer status OPEN/OFF/CLOSE; selection of the switching outputs (dual output)
Mixer 0-100%	A percentage value to one decimal place, for control of a mixer with 0-10 V input via an analogue output.
Remaining runtime ctr	Display of the remaining mixer runtime
Mixer open	Status ON when the mixer is fully open (after expiry of remaining runtime)
Mixer closed	Status ON when the mixer is fully closed (at expiry of remaining runtime)
<ul style="list-style-type: none"> The set value for control is also issued if Enable = Off. Mixer 0 – 100 %: Scaling of the analogue output: $0 = 0.00 \text{ V} / 1000 = 10.00 \text{ V}$ If the "Actual value" input variable is unused, then the value of input variable "Set value + Offset set value" is issued in % as the Set value for control. During the initialisation run, 100 % is shown when "Open" is selected and 0 % when "Close" is selected. Output variable "Mixer 0 – 100 %" is aligned with this value. This allows a precise set position in % to be specified for a mixer with 0 - 10 V input. The remaining runtime counts down from 20 minutes when a dual output (mixer drive) is linked to the Open/close mixer output variable. If a dual output is not linked, the remaining runtime counts down from 2 minutes. If the runtime limit was deactivated in the mixer output settings, the remaining runtime only counts down to 10 seconds and output pair control is not terminated. The remaining runtime (20 minutes) is reloaded if the mixer output is in manual mode, is switched by a message (to dominant ON or OFF), changes its direction of control from OPEN to CLOSE or vice-versa, or if Enable is switched. Mixer open / closed: If the runtime limit was deactivated, the mixers are still displayed as open or closed after the remaining runtime is complete. If inverse mode is selected, the output variables "Mixer open" and "Mixer closed" are also reversed. This means that if the mixer is completely closed after the remaining runtime is complete, then the status "Mixer open" changes to ON. During a controller start, an initialisation run is also started automatically in accordance with the parameter settings. 	

PID control

Function description

A system with specified sensors is controlled by means of the correcting variable in order to keep a sensor value constant or to maintain a constant differential between two sensor values.

Example of use: Changing the pump rate, which is to say the throughput, of circulation pumps. That allows the system to maintain constant temperatures (or temperature differentials).

PID control is not only suitable for speed control, however, but can also be used for burner or heat pump modulation, for example.

Description using a simple solar layout:

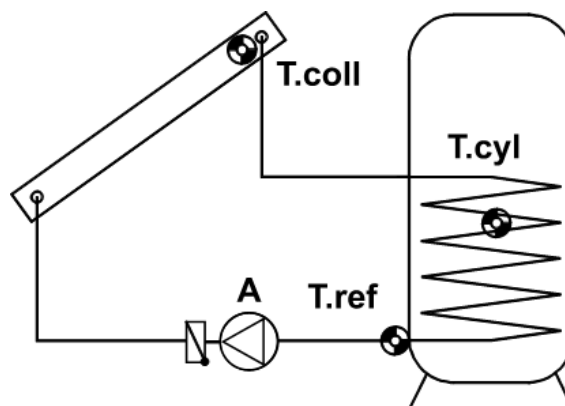

Absolute value control = maintaining a constant value at one sensor

T.coll is kept at a constant temperature (e.g. 60 °C) by means of speed control. If the insolation levels decrease, **T.coll** becomes cooler. The controller then reduces the speed and thereby the flow rate. That causes the heat transfer medium to stay in the collector for a longer heat-up time, which in turn increases **T.coll**.

Alternatively, in some systems (e.g. DHW cylinder charging) it may be useful to maintain a constant return temperature (**T.ref**). That requires an **inverse** control characteristic. If **T.ref** is increasing, the indirect coil is transferring too little energy to the cylinder. The flow rate is therefore reduced. A longer dwell time in the indirect coil cools the heat transfer medium more, thus reducing **T.ref**.

Keeping **T.cyl** constant would not be useful because changing the flow rate would not **directly** affect **T.cyl** and thus no functioning control loop would be created.

Differential control = maintaining a constant temperature differential between two sensors.

Keeping a constant differential in temperature between **T.coll** and **T.ref** results in modulating operation of the collector. If **T.coll** drops as a result of reduced insolation, the differential between **T.coll** and **T.ref** will drop as well. The controller then reduces the speed, leading to a longer dwell time of the medium in the collector, thus increasing the **T.coll - T.ref** differential.

Event control = If a defined temperature event occurs, event control activates, blocking absolute value control and/or differential control. The constant value is maintained at the relevant sensor in the same way as for absolute value control.

Example: The collector is to be kept at a certain temperature once **T.cyl** has reached 60 °C (the activation threshold).

Note: If absolute value control (maintaining a constant value at one sensor) and differential control (maintaining a constant differential between two sensors) are both active **simultaneously**, the **lower** value of the two methods wins out.

P-I-D values

The **proportional component P** amplifies the deviation between the set value and the actual value. The correcting variable is increased by **one** level (one increment) per **X * 0.1 K** deviation from the set value. A large number makes the system more stable and leads to greater control deviation.

If the **set value** and the **actual value** match, the **average** of the minimum and maximum correcting variables will be issued as the correcting variable.

Example: Minimum correcting variable **30**, maximum correcting variable **100**, set value = actual value -> correcting variable = **65**

The **integral component I** periodically adjusts the correcting variable in relation to the deviation remaining from the proportional component. For every **1 K** of deviation from the set value, the correcting variable increases by **one** level every **X seconds**. A larger number results in a more stable system, but the correction towards the set value is slower.

The **differential component D** causes a short-term overreaction the faster a deviation between the set value and the actual value occurs, in order to correct it as fast as possible. If the actual value deviates from the set value at a rate of **X * 0.1 K per second**, the correcting variable will be changed by **one** level. Higher values result in a more stable system but correction towards the set value is slower.

With the help of the **cycle time** parameter, the readjustment can be influenced via the **differential component**. A longer cycle time results in an **extended period** of influence for the differential component.

Pump stoppages

If the correcting variable is too small, it could, for example, result in check valves bringing the pump to a stop. At times that may be desirable, which is why stage 0 is permitted as the lower limit.

To determine the minimum correcting variable, slowly increase the speed stage in manual mode while observing the pump. The correcting variable at which the pump starts should be increased by a few levels to be on the safe side, and the result should be applied as the minimum correcting variable.

For the control of variable-speed high efficiency [HE] pumps, follow the pump manufacturer's instructions for the minimum correcting variable and control characteristics (standard/inverse).

Example: Characteristic of an HE pump with **inverse PWM control** (Heating mode) (source: WILO)

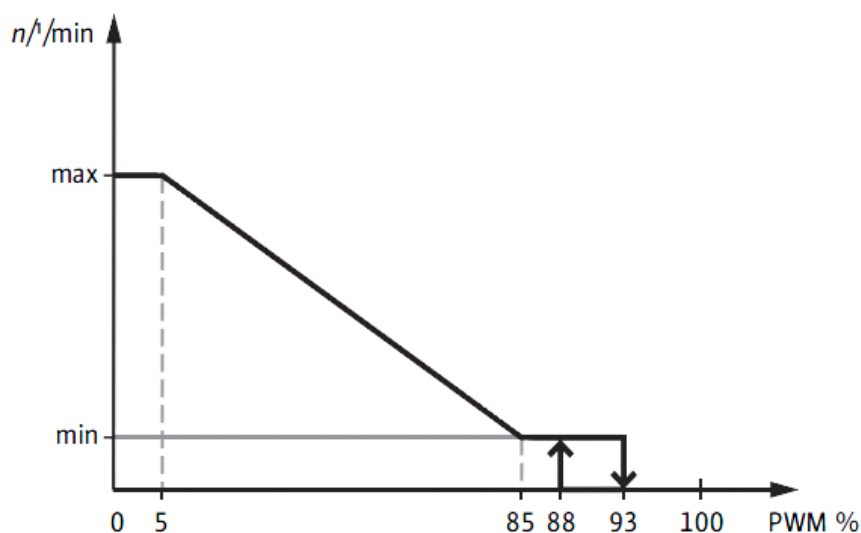

Input variable	
Enable	General enabling of the function (digital value ON/OFF)
Actual value, absolute value control	Analogue input signal from the sensor which is to be kept constantly at the set temperature
Set value absolute value control	Analogue value specifying the required control temperature
Actual value (+) differential ctrl	Analogue input signal from the warmer reference sensor (e.g. a collector sensor) for differential control
Actual value (-) differential ctrl	Analogue input signal from the cooler reference sensor (e.g. a cylinder sensor) for differential control
Set value, differential control	Analogue value specifying the required temperature differential
Activation value, event control	Analogue input signal from the sensor at which an event is expected
Activation threshold, event control	Analogue value specifying the activation threshold at the activation sensor
Actual value, event control	Analogue input signal from the sensor which will be kept constant after the occurrence of the event
Set value, event control	Analogue value specifying the set control temperature for event control
Proportional component	Analogue, dimensionless value between 0.0 and 100.0 The correcting variable is increased by one stage (increment) per $X * 0.1$ K deviation from the set value.
Integral component	Analogue, dimensionless value between 0.0 and 100.0 For every 1 K of deviation from the set value, the correcting variable increases by one stage (increment) every X seconds.
Differential component	Analogue, dimensionless value between 0.0 and 100.0 If the actual value deviates from the set value at a rate of $X * 0.1$ K per second, the correcting variable will be changed by one level.
Correcting variable maximum	Maximum permissible correcting variable (maximum 100 for PWM or 0-10 V control)
Correcting variable minimum	Minimum permissible correcting variable
Corr. var at start	Correcting variable after PID control is enabled (only effective if integral component > 0)
<ul style="list-style-type: none"> A typical result for such a DHW system ("Fresh water station") with a fast sensor is PRO = 3, INT = 3, DIF = 1 for pumps with PWM signal. Another setting proven in practice is PRO = 3, INT = 1, DIF = 4 with the use of a particularly fast temperature sensor. 	

Parameters	
Function quantity	A wide range of function quantities are available, which are applied together with their unit and their decimal places.
Cycle time	Cycle time = interval between measurements for correction via the differential value (see Function description / P-I-D values)
Reset integral counter (only visible if the "Corr. var at start" is unused)	If " No " is selected, PID control starts after enabling with the correcting variable that was last issued. If " Yes " is selected, PID control immediately begins after enabling, with the correcting variable calculated based on the input variables and parameters
Absolute value ctrl Mode Set value abs.	Available for selection: Off Standard = the correcting variable increases as the actual value rises Inverse = the correcting variable falls as the actual value rises Display of the set value
Differential control Mode Sollwert Diff.	Available for selection: Off Standard = the correcting variable increases as the actual value rises when event control is active Inverse = the correcting variable falls as the actual value rises when event control is active Display of the differential
Event control Mode Condition Activ. threshold Diff. on Diff. off Set value event	Available for selection: Off Standard = the correcting variable increases as the actual value rises when event control is active Inverse = the correcting variable falls as the actual value rises when event control is active Available for selection: Act. > threshold, Act. < threshold Display of the activation threshold Start differential for the activation threshold Stop differential for the activation threshold Display of the set value for control
<ul style="list-style-type: none"> • Each control method can be set to control modes <i>Standard</i> (correcting variable increases with rising actual value) or <i>Inverse</i> (correcting variable falls with rising actual value) or to <i>Off</i> (control method inactive). • Event control overwrites results from other control methods. A defined event will therefore block absolute value control or differential control. • Example: Absolute value control to keep collector temperature constant at 60 °C is blocked once the cylinder reaches 50 °C at the top = a usable DHW temperature has thus been reached quickly, and charging of the cylinder can now continue at the full flow rate (and consequently at a lower temperature). For this to work, the new set temperature entered in event control must be a value that will automatically result in pumping at full speed (e.g. for collector sensor = 10 °C). • If the Condition of event control is <i>Act. < threshold</i>, event control will be activated when the activation value falls below the activation threshold + Diff. off and will be deactivated again when it exceeds the activation threshold + Diff. on. With this condition, the two Diff. values are therefore effectively interchanged. • If both absolute value control and differential control are switched off (output: maximum correcting variable), then, when event control is activated, the control will change over from the maximum correcting variable to the value for event control. 	

Output variables	
Correcting var.	Dimensionless number = PID control result; selection of assignment to analogue outputs (PWM or 0-10 V control, e.g. of electronic pumps)
Cntrl diff. (act. – set)	Differential between the actual value and the set value of the control method that currently 'wins out'
Absolute value contrl active	Status ON if absolute value control is active
Differential control active	Status ON if differential control is active
Event control active	Status ON if event control is active
Corr. variable > 0	Status ON if the correcting variable is > 0
<ul style="list-style-type: none"> • With Enable OFF the correcting variable is zero • If all control modes are switched off, the maximum correcting variable is always issued. • If absolute value control and differential control are active simultaneously, the lower correcting variable from the two methods 'wins out'. • If two or more PID controls act on an output simultaneously, the higher correcting variable 'wins out'. • As an output variable, the correcting variable is also available to other functions. 	

Profile function

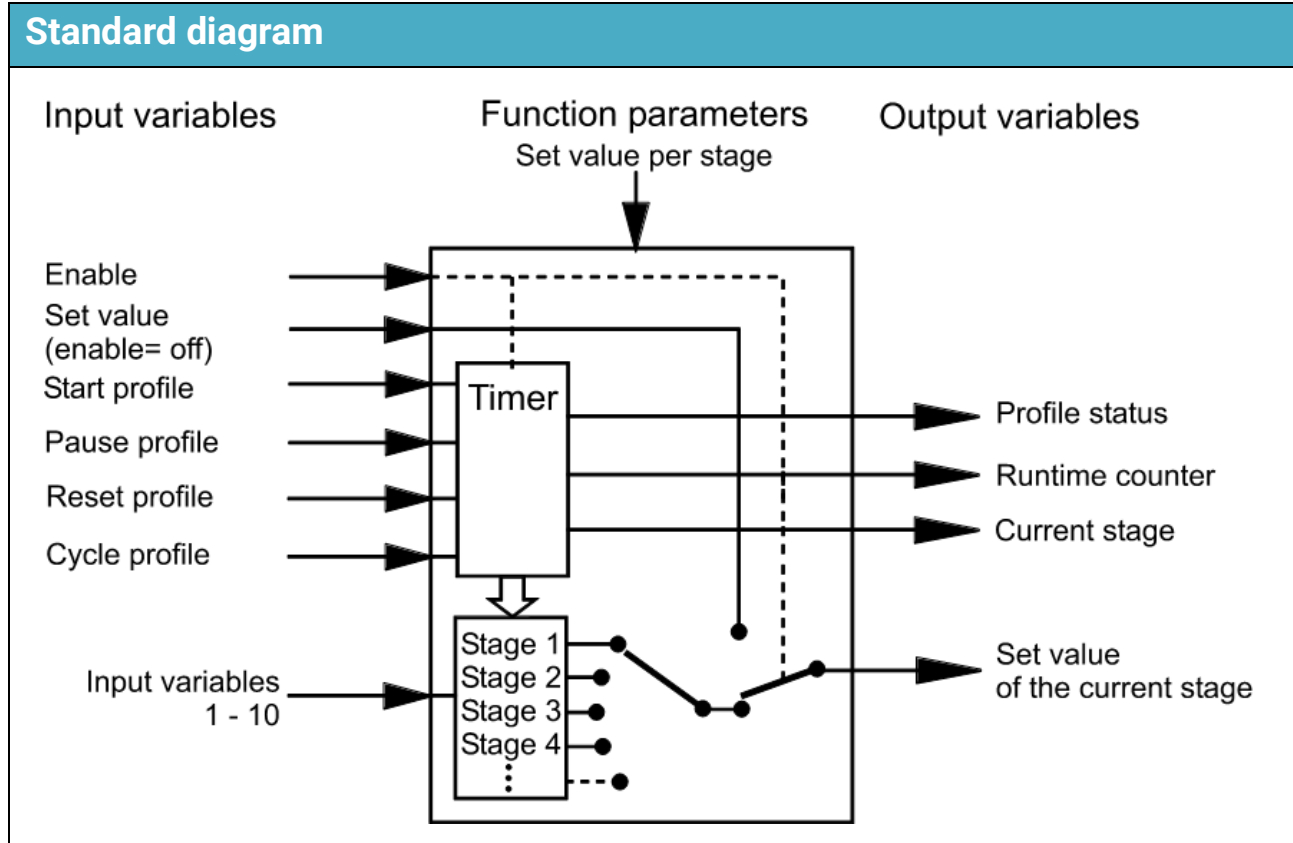

Function description

The Profile function generates a time-controlled output of up to 64 numeric values. In each cycle (stage), the system switches from one value to the next in a definable table and issues the new value as the set value. This allows a profile to be established, e.g. a temperature profile suitable for a screed drying program.

Input variables	
Enable	General enabling of the function (digital value ON/OFF)
Set value (enable = off)	Analogue value specifying the set value when Enable is OFF , the function is in stage 0 or OFF has been entered as the stage set value
Start profile	Digital input signal, ON/OFF, to start the function
Pause profile	Digital input signal, ON/OFF, to interrupt the running of the function
Reset profile	Digital input signal, ON/OFF, to reset the running of the function
Cycle profile	Digital input signal, ON/OFF, to advance to the next stage
Input variable 1 - 10	Analogue values from various sources which can be assigned to individual stages

- The **Input variables 1 - 10** allow the Profile function to issue values which are variable and which come from other sources (e.g. from sensors or other functions).
- **Start profile:** An ON pulse starts the function, which then runs once or cyclically, depending on the parameter settings. A further ON command while the function is running does not restart the function (no retriggering).
- **Pause profile:** An ON signal **interrupts** the runtime of the function for the duration of the ON signal. The runtime resumes if the pause signal switches to OFF again.
If, during the "**pause profile**" duration, the "**stop profile**" command is executed from the parameter menu or the "**reset profile**" input variable is set to **ON**, the function is immediately reset to **stage 0**, and the function stays switched off.
The **Pause profile** signal **blocks** the **Cycle profile** input signal.
- **Reset profile:** An ON pulse resets the function to stage 0. It can only be restarted by a Start command. The "**stop profile**" command in the parameter menu likewise has the effect of resetting the function to stage 0.
- **Cycle profile:** An ON pulse advances the function to the next stage. This ON pulse replaces the Internal cycle. The function must be started by a Start command, however. After the Start command, the function is at stage 1.
If the function is set to **cyclical** running, the Cycle pulse will cause the function to advance to the first stage again after completing the last stage. If the parameters are set for the function to run only **once**, it will switch to stage 0 after completing the last stage, deactivating the function.

Parameters	
Function quantity	A wide range of function quantities are available, which are applied together with their unit and their decimal places.
Number of stages	1 to 64 stages can be set.
Cyclical	Available for selection: Yes / No
Internal cycle (shown only if the Cycle profile input variable is unused)	Enter the cycling time for each profile stage
Stage 1 - (maximum) 64 Source stage 1 – (maximum) 64 Value (shown only for Value source)	Enter the source ((OFF, Value or Input variable I1 – I10) Enter the set value for Value source
Start profile or Stop profile	These buttons can be used to start the profile function or, if it is already active, to stop it.
<ul style="list-style-type: none"> • The profile function must be started initially either manually from the parameter menu or via the start profile input variable. • If "Cyclical: Yes" is selected, the function will begin again from the first stage after completing the last stage, until a reset command deactivates the function, or it is stopped from the parameter menu or "Enable" is set to OFF. • If Cyclical: No is selected, the function will be terminated and switched to stage 0 after completing the last stage. • If OFF is entered as the source for a stage, the value of the Set value (enable = off) input variable will be issued as the set value and Profile status will be set to OFF. 	

Output variables	
Set value	The currently valid set value
Current stage	The currently active stage
Profile status	Status ON while the Profile function is running. If the function is interrupted by means of the Pause profile input variable, the status still remains ON.
Runtime counter	Display of a countdown of the time of the currently active stage

Output variables

- If the function's Enable is set to OFF or the function is currently inactive, the value of the Set value (enable = off) input variable will be issued as the set value and the **Profile status** will be OFF.
- If the function has been interrupted by means of the **Pause profile** input variable, the **Profile status** remains ON.
- The output variable **Profile status** switches to **OFF** if the set value is set to 0, even if the profile is active.
- Internal cycle and a cycling time of **at least 1 hour**:
The profile stage is saved hourly to the internal memory.
Profile stage 1 is saved immediately after the start.
Stage 0 is saved immediately after "**Stop profile**" from the parameter menu or after "**Reset profile**".
Start and stop are saved immediately up to once an hour.
Therefore, if there is a power failure, only one stage at most can be lost when the power resumes.
- When loading function data, you will be asked whether you want to apply the saved counter/meter readings (see manual Programming Part 1: General information).

Sample & Hold

Standard diagrams

Trigger slope: pos. / neg.

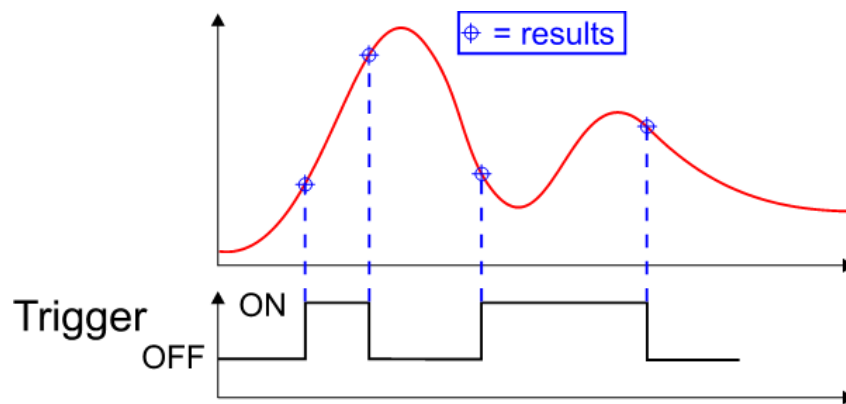

Trigger slope: positive

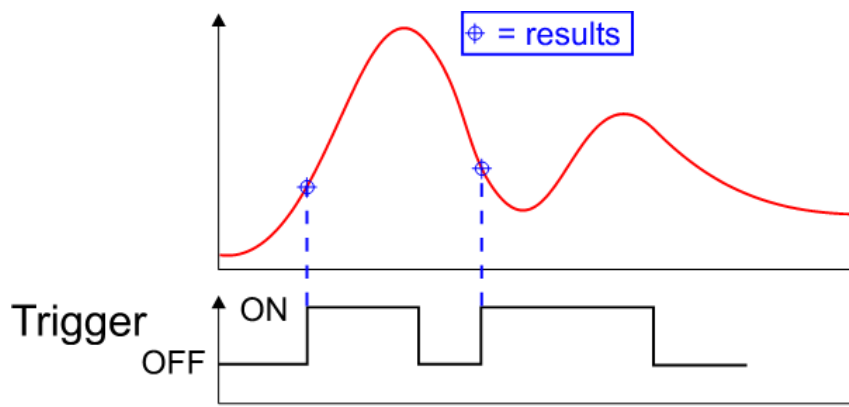

Trigger slope: negative

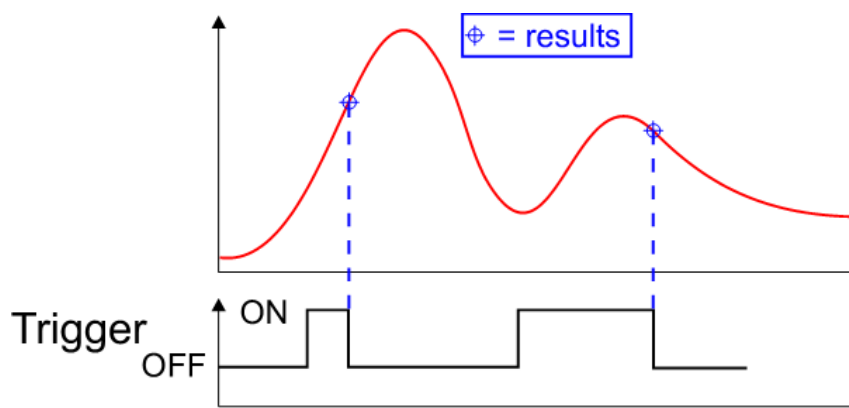

Function description

The Sample & hold function determines a value from an analogue input variable which applies at the time of a digital trigger input signal.

The user can choose between the trigger slopes **pos./neg.**, **positive** or **negative**.

Time switch

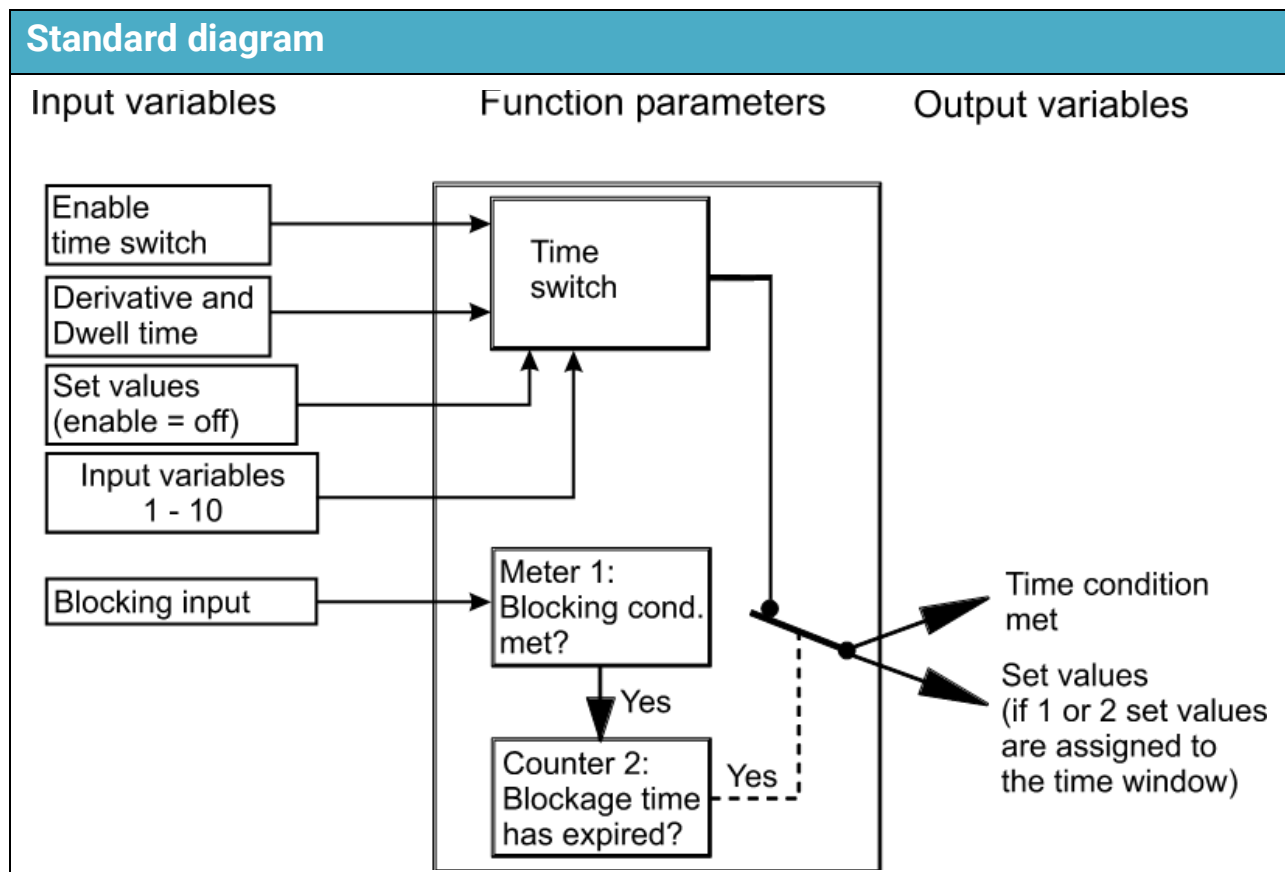

Function description

The Time switch function is a time-dependent switching function for functions or outputs.

Up to 7 time programs, each with 5 time windows, are available per Time switch function.

Two different **set of values** can be assigned to each time window as output variables.

The ON and OFF times can be defined **flexibly** by means of input variables (e.g. the system values for sunrise or sunset).

The Time switch function performs timer functions for the functions DHW demand, Shading, Individual room control, Heating circuit control, Cooling circuit control and DHW circulation by means of their **Time condition status** input variable.

The Time switch function can be programmed more than once, meaning that multiple time switches are available.

Input variables

Enable	General enabling of the function (digital value ON/OFF)
Blocking input	Digital input signal, ON/OFF, to block the Time switch function
Derivative time	Analogue value in minutes for bringing the ON time forward
Dwell time	Analogue value in minutes for pushing the OFF time back
Set value (1 - 2) (enable = off)	Analogue value specifying the Set value 1 / Set value 2 output variable when Enable is OFF (if the parameter settings have set values)
Input variable (1 -10)	Up to 10 analogue values, either for flexible ON and OFF times or for variable set values in the time windows

- The sources for the **Derivative time** and **Dwell time** can be other functions (e.g. Heating circuit control, Curve function). That allows the use of flexible start and stop times which vary depending on other parameters (e.g. the outside temperature).
- The sources for the input variables 1 - 10 can be fixed values, functions, sensors, network inputs or system values (e.g. sunrise).

Parameters

Number of set values	Enter the number of set values to be issued as output by the Time switch function. (Available for selection: 0, 1, 2)
Function quantity (1 - 2) (shown only if there are set values)	Define the function quantities for set values 1 or 2. A wide range of function quantities are available, which are applied together with their unit and their decimal places.
Time program	Sub-menu: Time program for the time switch (see Time program sub-chapter)
Set value (1 -2) if time prog. = Off (shown only if there are set values)	Set values 1 or 2 outside the time window
Min. time blocking cond. (shown only if the blocking input is defined)	The blocking input must be ON for at least the time defined here in order to block the time switch output.
Blocking time, time switch (shown only if the blocking input is defined)	Once the minimum time for the blocking condition is reached, the time switch will be blocked from the end of the blocking condition until the end of the blocking time defined here.

- **If the Number of set values is set to 0, the output for both set values will be 0.**
- **Blocking function:** If the blocking input has the status **ON** for the duration of the **minimum blocking time**, the **Time condition status** will be set to **OFF** and the set values **Set values (1 -2) if time prog. = Off** will be issued.
If the status of the blocking input then returns to **OFF**, the **blocking time** will begin to run, and the set values **Set values (1 -2) if time prog. = Off** will continue to be issued.
At the end of the blocking time the Time switch function returns to the status of the time condition and issues the assigned set values.

Submenü Zeitprogramm

View with two set values, without input variables

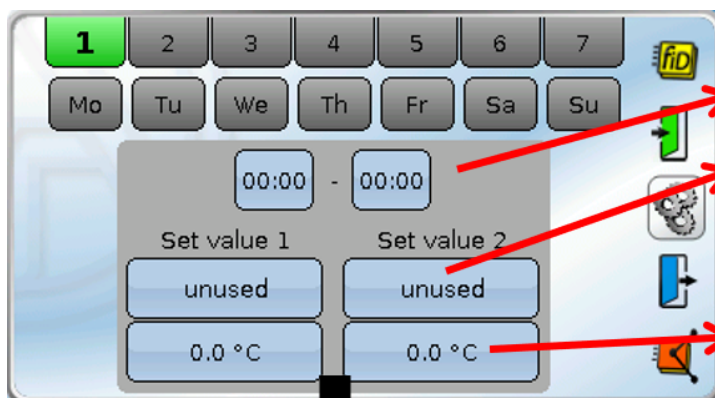

1st time window

Setting specifying whether the set value remains unused, is user defined **or** should have the value of one of the 10 input variables.

User defined value (only effective if **user def.** is selected above).

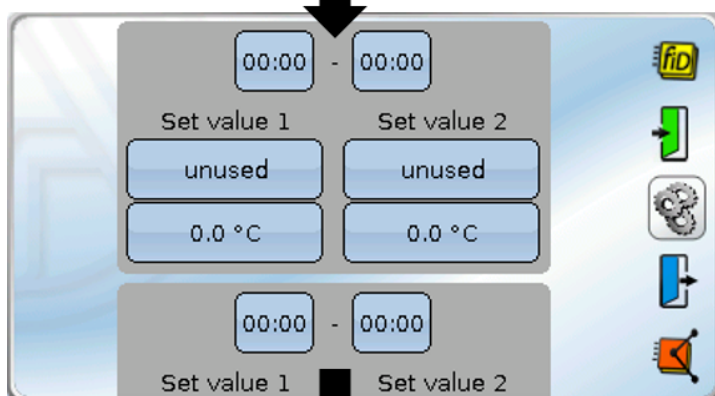

Scroll down to consecutively view all 5 time windows in time program 1.

Up to **7 time programs**, each with **5 time windows**, are available for selection for the Time switch function.

The start and stop times of each time window can be shifted by means of **input variables**.

Two different **set values** can be issued as output for each time window.

Settings in the time windows specify whether each set value stays **unused** (output will be **Set value if time prog. = Off**) or whether a required set value should apply.

That set value can be a user defined value **or** the value of an input variable.

Outside the time window, the applicable **Set value if time prog. = Off** will be issued.

View if **no set values** should be issued and no input variables were defined:

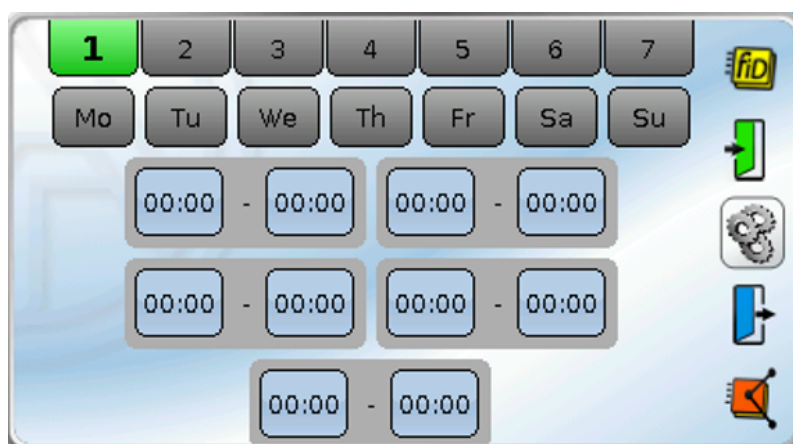

Only the 5 time windows can be seen.

Examples of time programs

Time program 1 with fixed start and stop times, set values and without defined input variables

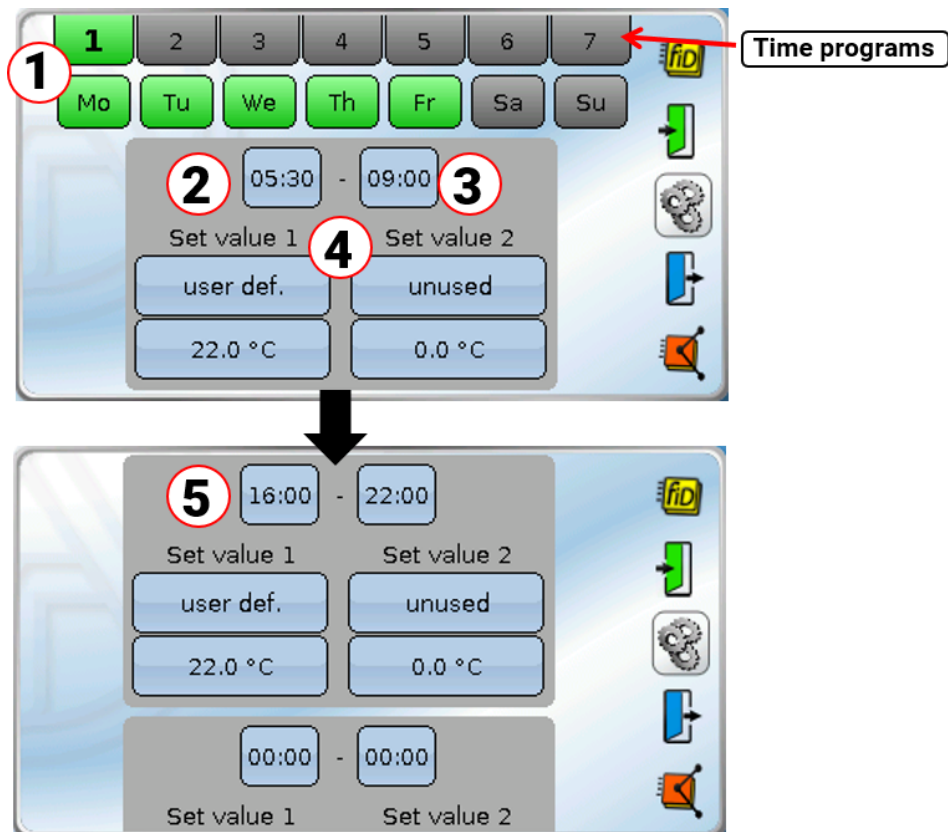

Settings:

1. Time program **1** has been set for the days **Monday to Friday**.
2. The start time of the first time window is 05:30 h
3. The stop time of the first time window is 09:00 h
4. Set value 1 is a value defined by the user (22.0), set value 2 is unused (output: **Set value 2 if time prog. = Off**).
5. The start time of the second time window is 16:00 h, the stop time is 22:00 h with a set value 1 of 22.0, and set value 2 is unused (output: **Set value 2 if time prog. = Off**).

Time program 1 with variable start and stop times depending on sunrise and sunset, with set values

Assumptions: Input variable I1 = system value for sunrise

Input variable I2 = system value for sunset

Input variable I3 = value from another function

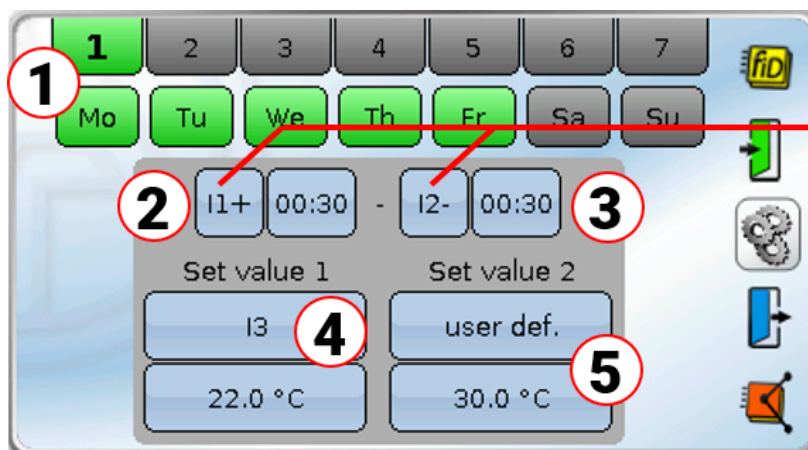

These fields are only shown if at least one input variable has been defined.

Settings:

1. Time program **1** has been set for the days **Monday to Friday**.
2. The start time is **input variable I1 (= sunrise) + 30 minutes**, i.e. 30 minutes **after** sunrise. The time specified here is an **offset value** for the input variable, with the **plus** after I1 indicating that the offset value is **added** to the variable.
3. The stop time is input variable I2 (= sunset) - **30 minutes**, i.e. 30 minutes **before** sunset. The time specified here is likewise an **offset value** for the input variable, with the **minus** after I2 indicating that the offset value is **subtracted** from the variable.
4. Set value 1 is the input variable I3. The value below that (22.0 °C) is **not** effective.
5. Set value 2 is a value defined by the user (30.0 °C).

Output variables	
Time condition status	Status of the time switch function ON/OFF taking into consideration the derivative time, dwell time and blocking function
Set value (1 – 2)	Issue of the current set values 1 / 2
Minimum timer	Display of the elapsed minimum time for the blocking function
Blocking timer	Display of a countdown of the blocking time
Effective time window	Status ON when the time window applies, even if the blocking function sets the time condition status to OFF. The derivative time and dwell time extend the time condition status, so the "Effective time window" will be ON in those periods as well.
Time window	As with "Effective time window", but not taking into consideration the derivative time and dwell time
<ul style="list-style-type: none"> • If enable OFF is selected, the time condition status, the effective time window and the time window are also OFF. • Set value (1 -2): <ul style="list-style-type: none"> • If the Number of set values has been set to 0, the output for both set values will be 0. • If set values have been defined for the current time window, those values will be issued during the time window. Outside the time window, the parameter values Set value (1 -2) if time prog. = Off will be issued. • If no set values have been defined in the current time window, then the parameter value Set value (1 -2) if time prog. = Off will always be issued. • The value in Set value (1 -2) if time prog. = Off will be issued during the blocking time, even if the time window is active. • When Enable is OFF the Set value (1 – 2) (enable = off) input variables will be issued. • If several time windows with different set values overlap, then the highest value from these set values is applied. 	

Scaling function

Standard diagram

Scaling as per parameter example:

0°C ⇒ 20%

50°C ⇒ 100%

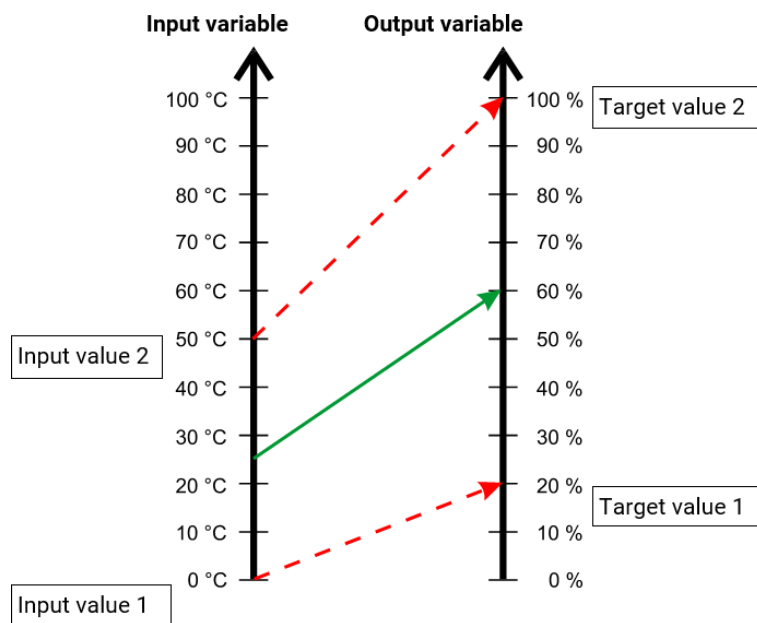

Function description

The Scaling function allows conversion of analogue values from sources selected by the user (sensors, functions, network inputs, etc.):

- Conversion of the function quantity
- Scaling of the input variables = matching the value to a new reference range
- Limitation of the output variables by means of minimum and/or maximum thresholds

Input variables

Enable	General enabling of the function (digital value ON/OFF)
Result (enable = off)	Analogue value for the output variable when Enable is OFF
Input variable	Analogue values to which scaling is to be applied
Result minimum	Minimum value of the output variables
Result maximum	Maximum value of the output variables

- The minimum and maximum output thresholds will limit the value of the output variables even if the scaling would have produced a lower or higher value.
However, these thresholds are only effective if they are activated in the limit parameter.
- If the Scaling function is blocked (Enable = Off), it issues a value which is either defined by the user with **Result (enable = off)** or which comes from a specific source.
- The **Result (enable = off)** value will **not** be limited by the maximum and minimum thresholds.

Parameters	
Limit Activate the input variables "Result minimum/maximum"	Available for selection: none, Minimum, Maximum, Min. and max. Minimum: Only the minimum limit, "Result minimum", takes effect Maximum: Only the maximum limit, "Result maximum", takes effect Min. and Max.: Both limits take effect
Function quantity Input Output	Definition of function quantities for input and output variables A wide range of function quantities are available, which are applied together with their unit and their decimal places.
Scaling Input value 1 Target value 1 Input value 2 Target value 2	Entry of input values and target values
<ul style="list-style-type: none"> Example: <div style="text-align: center;"> </div> <p>This yields a percentage which corresponds to a temperature. So, for example, if the input variable was 25.0 °C, the output would be 60.0 %.</p> 	

Output variables	
Result	The result produced by the scaling; optional selection of an analogue output
Result > minimum	Status ON if the result of the scaling calculation is above the minimum threshold (applies only if: Enable function = ON and Limit = Min. and max. or Minimum)
Result < maximum	Status ON if the result of the scaling calculation is below the maximum threshold (applies only if: Enable function = ON and Limit = Min. and max. or Maximum)
<ul style="list-style-type: none"> Scaling truncates the result by removing the last decimal places; the result is not mathematically rounded. 	

Solar cooling

Function description

Solar thermal systems often have an unusable excess yield during the summer months. This function can be used at night to dissipate some of the excess energy by pumping it at a controlled rate from the lower section of the cylinder into the collector, after a critical temperature is exceeded in the cylinder. System downtime during the day as a result of excess temperature shutdown can often be prevented in this way.

Input variables

Enable	General enabling of the function (digital value ON/OFF)
Reference temperature	Analogue input signal from the sensor which will trigger the function
Minimum reference temperature	Analogue value specifying the temperature threshold T.ref. min. which will trigger the function
Offset min. reference temp.	Analogue value specifying an offset for the minimum reference temperature

Parameters

Time window Start End	Time window for active cooling This time window applies only to the cooling process itself. The reference temperature is constantly monitored.
Reference temperature T.ref. min. Diff. on Diff. off	Display of the temperature threshold (input variable) Start differential for T.ref. min. Stop differential for T.ref. min.
Correcting var.	Setting for the correcting variable for the pump; selection of the analogue output
<ul style="list-style-type: none"> • Energy saving: Tests have shown that adequate cooling can be achieved even at low speeds. We therefore recommend that you use a speed stage just above zero circulation. 	

Output variables

Cooling	Pump status ON/OFF; selection of the output
Correcting var.	The correcting variable as currently set; selection of an analogue output for electronic pumps
Set reference temperature	Display of the T.ref. min. temperature threshold including the Offset value
Time window	Status ON when the time window applies
T.ref. > T.ref. min.	Status ON if $T.ref. > (T.ref. min. + Offset + Diff.)$

Solar control

Standard diagram

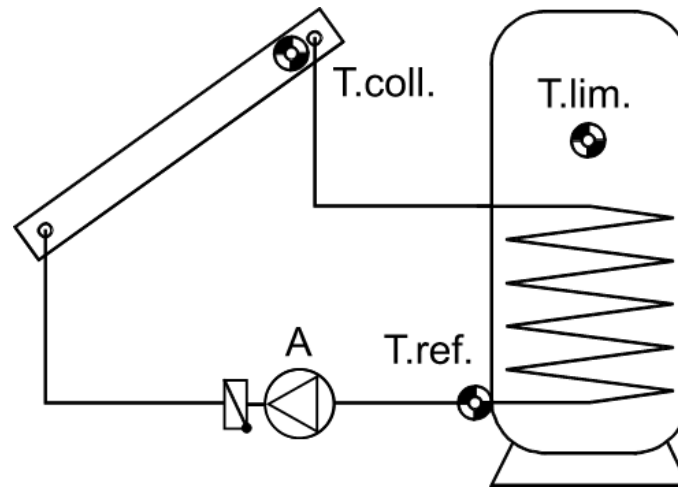

Function description

Differential control between the collector temperature and reference temperature (e.g. cylinder temperature) for operation of a solar circuit pump. Optional: use of a limit sensor.

Start conditions for solar circuit pump A:

1. The collector temperature $T_{coll.}$ must exceed the minimum threshold $T_{coll. min.}$ and must not exceed the maximum threshold $T_{coll. max.}$
2. The adjustable differential between $T_{coll.}$ and the reference temperature $T_{ref.}$ (= cylinder outlet temperature) must be exceeded.
3. $T_{ref.}$ must not yet have reached its maximum limit $T_{ref. max.}$
4. An **optional** maximum limit $T_{lim. max.}$ can also be defined for $T_{lim.}$

Input variables

Enable	General enabling of the function (digital value ON/OFF)
Collector temperature	Analogue input signal for the collector temperature $T_{coll.}$
Reference temperature	Analogue input signal for the reference temperature $T_{ref.}$
Limit temperature	Optional: Analogue input signal for the limit temperature $T_{lim.}$
Minimum collector temp.	Analogue value specifying the minimum temperature at the collector, $T_{coll. min.}$
Max. reference temp.	Analogue value specifying the maximum reference temperature, $T_{ref. max.}$
Maximum limit temp.	Analogue value specifying the maximum limit temperature, $T_{lim. max.}$

- In the case of cylinders with smooth tube indirect coils, it is advisable to insert the reference temperature sensor into the heat exchanger outlet using a tee and a sensor well (see Installation instructions / Sensor installation).
- If the surface area of the collector is too large, the return temperature will rise too rapidly, causing premature shutdown of the system due to the limit at $T_{ref.}$. However, $T_{ref.}$ will also drop quickly through stationary fluid in the cold section of the cylinder. The pump will then restart, with the same consequences. To prevent this cycling and to prevent overheating in good quality stratification cylinders, an **additional, optional** maximum limit can be imposed at $T_{lim.}$

Parameter	
Collector temperature T.coll. max. Diff. on Diff. off T.coll. min. Diff. on Diff. off	Pump blocking if T.coll. max. is reached at the collector sensor Start differential for T.coll. max. Stop differential for T.coll. max. Display of the minimum temperature at the collector sensor Start differential for T.coll. min. Stop differential for T.coll. min.
Reference temperature Diff. on Diff. off	Start differential for T.ref. max. Stop differential for T.ref. max.
Differential coll. ref. Diff. on Diff. off	Start differential, collector - reference Stop differential, collector - reference
Limit temperature (shown only if an input signal is defined for the limit temperature T.lim.) Diff. on Diff. off	Optional: Stop threshold at the limit sensor T.lim. Start differential for T.lim. max. Stop differential for T.lim. max.
Stabilisation time	Optional: Minimum time within the time window (e.g. for drainback systems)
Time windows (shown only if a stabilization time is entered) Start End	Definition of the time window in which the stabilisation time is activated
<ul style="list-style-type: none"> • When the collector exceeds a certain temperature (e.g. 130 °C) the system comes to a halt and it is assumed that steam is present in the collector, usually making circulation of the heat transfer medium impossible. For this reason, T.coll. has an adjustable maximum limit (T.coll. max). • The pump is switched off if either the T.ref. sensor captures a temperature in excess of the T.ref. max. threshold + Diff. off <u>or</u> if the T.lim. sensor (if installed) captures a temperature in excess of the T.lim. max. threshold + Diff. off. • If the limit sensor T.lim. is used, the maximum threshold T.ref. max. of the reference sensor should be set so high that it has no effect on operation. • During the stabilization time, the solar circuit pump will run from the start irrespective of the temperature differential between the collector sensor and cylinder sensor and the minimum threshold T.coll. min. at the collector. The thresholds T.ref. max. and T.lim. max. remain active. If the solar thermal system does not meet the start conditions at the end of the stabilization time, the pump will be shut down. • If the Drainback function is activated, the stabilization time will be restarted at the end of the filling process. 	

Output variables	
Solar circuit	Solar circuit status ON/OFF; selection of the output
Maximum limit	Maximum limit status ON/OFF (ON = cylinder limit reached at T.ref. or T.lim.)
T.coll. < T.coll. max.	Status OFF if the maximum limit at the collector is active.
T.coll. > T.coll. min.	Status ON the collector temperature is higher than the minimum threshold.
T.ref. < T.ref. max.	Status ON the reference temperature is lower than the maximum threshold T.ref. max.
T.lim. < T.lim. max.	Status ON if the temperature at the limit sensor is lower than T.lim. max.
T.coll. > T.ref.	Status ON if the collector temperature is higher than the reference temperature by the amount of Diff. on or Diff. off.
Priority	Status OFF if the solar function is deactivated by the Solar priority function .
Time window	Status ON when the time window for the stabilisation time applies
Stabilisation time ctr	Counter which counts down the stabilisation time
Blocking (drainback f.)	Status OFF if the solar function is prevented from starting by blocking during the blocking time of the Drainback function.
<ul style="list-style-type: none"> • The Maximum limit output variable switches to status ON if the maximum threshold of the reference sensor T.ref. max. or the maximum threshold of the limit sensor (if connected) T.lim. max. is reached. • If no Solar priority function has been programmed, the Priority output variable is always set to status ON. • If there is no stabilization time defined, the Time window output variable is always set to status ON. • If there is no Drainback function programmed, the Blocking (drainback f.) status is always set to ON. 	

Solar start / Drainback

Function description

The function has two different modes

Solar start

In solar thermal systems, the heated heat transfer medium sometimes takes too long to reach the collector sensor, causing the system to start too late. This insufficient gravity rise occurs mainly with flat-mounted collector arrays, absorber strips in meander configurations, and vacuum tube collectors.

The start function puts the solar circuit pump into operation briefly at intervals, transporting the content of the collector to the sensor. To prevent energy losses, this interval operation is started only within a time window and only when the insolation at the **GBS01** radiation sensor (special accessory) reaches a certain level, or subject to monitoring of the collector temperature. Without a radiation sensor, the controller first attempts to determine the current weather conditions by means of the actual [captured] collector temperature. That allows it to identify the right time for the solar start function's flushing process.

A separate start function is required for each collector array with an assigned collector sensor.

Drainback

In drainback solar thermal systems, the collector area is **drained** outside the circulation time. In the simplest scenario, an open expansion vessel is installed near the solar circuit pump, which collects all the heat transfer medium higher than the vessel when the pump is stopped.

The **system is started** either by means of a **radiation sensor** or when the **Diff. on** temperature differential between the collector sensor and cylinder sensor is exceeded.

During the **filling time**, the pump must raise the heat transfer medium over the highest point of the system. If there is variable speed control, it must be programmed so that the pump runs at full speed (e.g. digital command on analogue output). Optionally, a second pump (booster pump) can also be connected to a free output in order to increase the filling pressure.

At the end of the filling time, the stabilization time starts (setting in the Solar control function). The collector sensor should reach the start differential within the **stabilization time**, after having been cooled down by the filling process. Speed control is recommended as the pump will then run at least at its minimum speed during this time, allowing the collector to be heated more quickly. If the collector sensor does not reach the start differential at the end of the stabilization time, the system will be drained and a restart cannot occur until the **blocking time** has elapsed.

If the pump is switched off during standard operation (e.g. due to the temperature differential falling below **Diff. off** or shutdown due to excess temperature in the collector), the system will be drained. A restart is only possible once the blocking time has elapsed and the start condition is met.

A separate Drainback function is required for each collector array.

The Solar priority function and the Solar start function must not be used with drainback systems.

Input variables for solar start / drainback

Enable	General enabling of the function (digital value ON/OFF)
Solar radiation	Analogue input signal from the radiation sensor
Reference temp.	Analogue input signal from the collector sensor

Parameters solar start	
Mode	Available for selection: Solar start func.
No. of functions included	Enter the number of functions included
Included functions	Sub-menu: List all the solar functions for the relevant collector array
Activation time (from – to)	Time window in which the start function is permitted
Flushing time	Flushing time
Interval time	Maximum delay between flushes
Activation gradient oder	Without radiation sensor: The controller uses the activation gradient to calculate a required temperature increase over the long term average of the reference temperature , which will start the flushing process. Setting range: 0-99
Radiation threshold	With radiation sensor: Radiation threshold in W/m^2 at which a flushing process is permitted.
<ul style="list-style-type: none"> • If one of the included functions is active, the controller will not try to start the system. • If a radiation sensor is used, instead of Activation gradient the computer displays the required radiation threshold above which the start function is to be active. • If the collector sensor specified in the input variables under Reference temp. is heated by the sun, the radiation sensor can often be dispensed with. In that case, an average will be calculated for the collector temperature, with special weighting given to the lowest temperatures reached. The start function is activated when the collector temperature is hotter than the average by the differential of the activation gradient. A lower activation gradient therefore leads to an earlier start attempt, and a higher gradient to later attempts. If it takes more than ten attempts to start the system, the activation gradient should be increased; if it takes less than four attempts, the gradient should be reduced. • As soon as one of the included solar functions is activated during a start attempt, the start function will be terminated once the interval time has elapsed. • If the activation gradient is set to zero, then only the activation or interval time will apply and the temperature curve at the collector sensor will be ignored. 	

Parameter Drainback	
Mode	Available for selection: Drainback func.
No. of functions included	Enter the number of functions included
Included functions	Sub-menu: List all the solar functions for the collector array
Activation time	Time window in which the drainback function is permitted
Filling time	When the system is started due to the radiation value or the temperature differential between the collector sensor and cylinder sensor, the outputs for system filling will be switched on for the duration of the filling time.
Blocking time	Blocking time between two filling processes. This prevents the Drainback function from starting too frequently. The blocking time begins at the end of the filling process.
Radiation threshold (shown only with radiation sensor)	Radiation threshold in W/m ² at which a filling process is permitted.
<ul style="list-style-type: none"> • Without radiation sensor: For the Drainback function to start, the collector sensor of an included solar function must be heated by insolation up to the solar function's start threshold. • The set filling time should be adjusted during commissioning so that it matches the actual filling time of the system. • When the collector is filled with the cold heat transfer medium, the collector temperature will temporarily fall below the Diff. off switching differential between the collector sensor and cylinder sensor. For this reason, it is possible to set a stabilization time in the Solar control function. This stabilization time starts immediately when the solar function starts, independently of the filling process, and starts again at the end of the filling process. The solar circuit pump will keep running during that stabilization time irrespective of the minimum temperature at the collector and the temperature differential between the collector sensor and cylinder sensor. • In order to heat the collector more quickly during the stabilization time, it is recommended to control the speed of the solar circuit pump with PID control. That will cause the pump to run at least at the minimum speed during the stabilization time, allowing the start differential for solar control to be exceeded. 	

Output variables for solar start / drainback	
Flushing/filling process	Pump status ON/OFF; selection of the switching and analogue outputs for the flushing or filling process
Time window	Status ON when the time window applies
Flush/fill timer	Display of a countdown of the flushing or filling time
Interv/block timer	Counter which counts down the interval or blocking time
Start attempts	Sum total of attempted starts today
Start att unsucc	Number of unsuccessful starts
Start attmpts since last run	Number of attempts since the solar thermal system last operated correctly
<ul style="list-style-type: none"> • Drainback function: The selection of outputs for the filling process allows a booster pump to be specified in addition to the solar circuit pump during the filling process. • If the solar circuit pump has variable speed control in PWM or 0-10 V mode, it is advisable to specify the analogue output for the filling process as well and to set its output value (On) to 100 % or 10.00 V respectively. The pump will then be operated at full speed during the filling process. 	

Solar priority

Function description

In solar thermal systems which supply more than one consumer (e.g. a DHW cylinder, buffer cylinder, pool), priorities normally need to be set for the various circuits. There are two basic methods for controlling a system of higher and lower priorities.

- **Absolute priority:** The temperature in the higher priority cylinder must have reached its limit (MAX threshold) before the system will switch to the next lower priority.
- **Relative priority:** Charging starts with the cylinder with which the collector reaches the start differential **first**, even if it is a lower priority consumer.

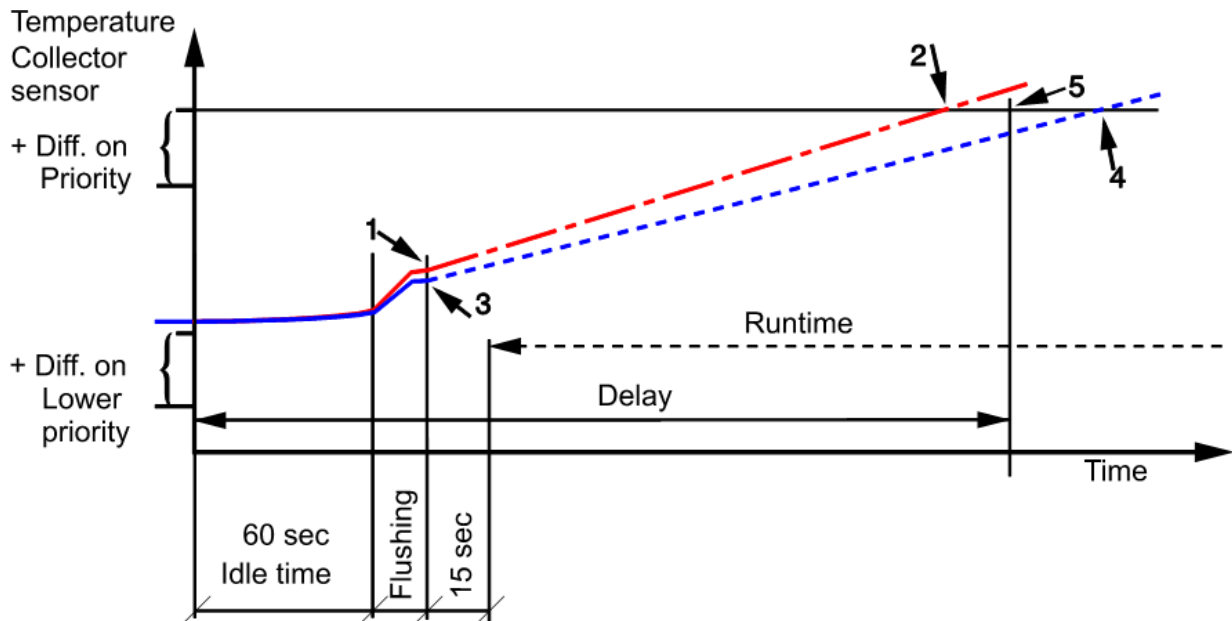

The device monitors the collector temperature while the lower priority consumer is being charged. If, while the pump is running, the collector temperature once again reaches the **start** differential (collector – reference) for the consumer **currently** being charged, the priority timer will be activated. If a radiation sensor is being used, the radiation level must exceed a threshold value, instead of the temperature differential.

The priority timer shuts down the pump for the idle time (60 s). After the flushing period (1 / 3) the controller calculates the increase in the collector temperature. It recognises whether the programmed delay will suffice to heat the collector to the temperature for the higher priority consumer (5). In case 2, the system waits to change over to the higher priority, as the collector temperature will reach the start temperature for the higher priority consumer before the end of the delay. If the controller determines that the increase within the delay will not suffice (case 4), it aborts the procedure and must wait until the end of the runtime before reactivating the priority timer with the idle time (60 seconds). The system remains in the lower priority during the runtime.

Input variables

Enable	General enabling of the function (digital value ON/OFF)
Insolation	Optional: Analogue input signal from the radiation sensor in W/m ²

Parameters	
No. of functions included	Enter the number of functions included
Included functions	Sub-menu: List all solar functions
Priority (list of the included solar functions)	Specify the priority level If Off is entered, the relevant solar function is disabled .
Lower prio. timer from priority level	Specify the priority level from which relative priority is to apply. For higher priority levels the Absolute priority applies. If 1 is entered, relative priority will apply to all levels.
Threshold value (shown only with radiation sensor)	Activation threshold in W/m ² for the priority timer. This threshold must be exceeded at the end of the runtime in order for the priority timer to be able to start with the idle time (60 seconds).
Runtime	ON time of the lower priority consumer, until the next start of the priority timer
Delay	The collector must be able to reach the start temperature for the higher priority consumer within this time otherwise the system will continue to charge the lower priority consumer.
Flushing duration	Specify the duration of the flushing period after the idle time. About half the content of the collector must be pumped past the collector sensor during this time.
<ul style="list-style-type: none"> • The program automatically looks for all of the values needed in the included function modules and also automatically blocks the included modules that are lower in priority. The action of the priority function is visible in the output variables of the solar functions. • Equal priority levels can be assigned as well. However, this is generally only useful if the system has multiple collector arrays. In that case, solar functions which apply to the same cylinder are set to the same priority level. • If, for example, Lower prio. timer from priority level 2 is specified, the solar functions with priority 1 will be permitted first until the consumers have reached their maximum temperatures (absolute priority). Only then does the priority processing of the other solar functions begin, via the priority timer (relative priority). • If the Runtime is set to 0, absolute priority will apply to all the included solar functions. • If the activation threshold of the radiation sensor is set too high and solar functions become active even though the threshold has not yet been reached, absolute priority will apply to those functions. 	

Ausgangsvariablen	
Flushing process	Pump status ON/OFF; selection of the output for the flushing process
Runtime counter	Display of the runtime (which starts 15 seconds after the end of the flushing time)
Delay timer	Display of the delay (which starts when the priority timer starts)
Absolute priority	Status ON when absolute priority is active via the from priority level entry or the Runtime is set to 0. The starting of the next level will not be permitted as the priority levels with absolute priority have not yet reached their maximum temperature.
<ul style="list-style-type: none"> • If the priority timer has been started with the delay and a start situation for a higher priority consumer arises within that time, that higher priority level will only start after the delay and flushing time + 15 seconds. During the runtime, the changeover from the lower priority to the higher priority takes place immediately. 	

Start-stop

Standard diagram

Basic principle:

Input (push button) ON OFF

Output ON OFF

Symbol of a latching relay in electrical engineering:

Function description

The Start-stop function is the equivalent of an electrical **latching relay**. Latching relays are also referred to as keep relays, impulse switches or remote control switches. Each time the button is pressed (= ON pulse signal), there is a change in the switching state at the "**Changeover**" input variables, which is saved until the next ON pulse.

Eingangsvariablen

Enable	General enabling of the function (digital signal ON/OFF)
Changeover	Digital input signal (pulse) for changeover
Switch on	Digital input signal (pulse) only for switching on
Switch off	Digital input signal (pulse) only for switching off

- The **switch on** and **switch off** input variables are especially suitable for switching several start-stop functions on or off at the same time. With the next pulse at "**Changeover**", the switching state is changed again.

Parameters

No parameters to change	
On or Off	Can be manually switched by tapping

Output variables

Result	Status output variable ON/OFF; selection of the output
Inverse result	Inverse status output variable ON/OFF; selection of the output

- If Enable is OFF, then both output variables are set to status OFF. If the function is switched back to Enable ON after Enable OFF, the result will always be OFF and the inverse result will always be ON. In other words, the last switching state is not saved.
- The last switching state is likewise **not** saved in the event of a power failure or a controller start.
- The start-stop function can also be started and stopped manually from the **parameter menu**.

Date-specific memory

Function description

The date-specific function enables daily, monthly and annual recording of meter readings.

The 2 different versions allow either the total meter readings for specific times, or the values for a time period (day, month, year) to be established.

The integral mathematics function can, for example, calculate the performance factor of a heat pump.

Input variables

Input variables A - D

Analogue input signal for the value to be saved

Parameters

Mode

Selection: **Differential, Value**

Function quantity

A wide range of function quantities are available, which are applied together with their unit and their decimal places.

- **Differential mode:** The **differentials** of the calculated values between beginning and end of the day, month and year are saved. This version is suitable, for example, for calculating the daily, monthly and annual performance factor of a heat pump.

Example: Daily value

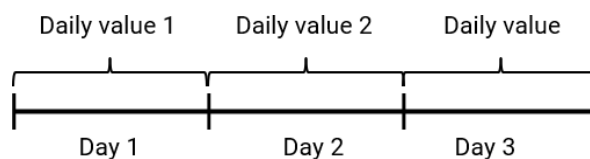

- **Value mode:** The calculated values (e.g. meter readings) **for the respective point in time** (end of day, end of month, end of year) are recorded.

Example: Daily value

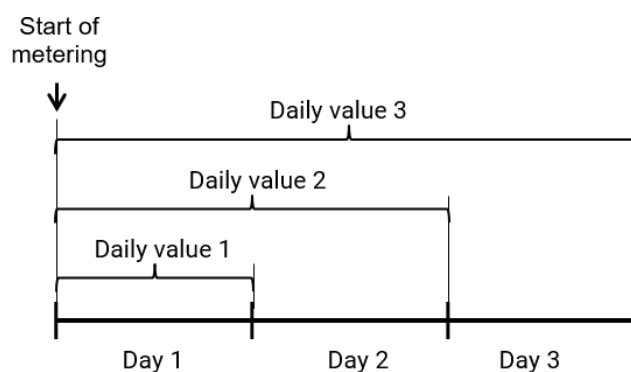

Calculation

With the help of the integral mathematics function, the input variables A - D can be linked mathematically.

If only one input variable is available, variables B to D remain on value 1 and the operators on "multiplication". The result of the calculation is therefore identical to input variable A.

The result of the calculation is then saved in accordance with the mode

View on display

[] ((A [] B) [] (C [] D))

Function	<input type="text"/>	Operator 2	<input type="text" value="x"/>
Input variable A	1.00000	Input variable C	1.00000
Operator 1	<input type="text" value="x"/>	Operator 3	<input type="text" value="x"/>
Input variable B	1.00000	Input variable D	1.00000

View in TAPPS2

Formula: ((ΔA x ΔB) x (ΔC x ΔD))	
Function	
Input variable A	1,00000
Operator 1	x
Input variable B	1,00000
Operator 2	x
Input variable C	1,00000
Operator 3	x
Input variable D	1,00000

The arithmetic operation is performed according to the following formula:

$$\boxed{\text{Function}} \left((A \boxed{\text{Operator 1}} B) \boxed{\text{Operator 2}} (C \boxed{\text{Operator 3}} D) \right)$$

- The first field **Function** can remain empty, in which case it has no effect on the arithmetic operation. In this field, a function can be selected which will be applied to the result of the arithmetic calculation that follows:
 - Absolute value **abs**
 - Square root **sqrt**
 - Trigonometric functions **sin, cos, tan**
 - Inverse trigonometric functions **arcsin, arccos, arctan**
 - Hyperbolic functions **sinh, cosh, tanh**
 - Exponential function e^x **exp**
 - Natural and common logarithms **ln** and **log**
- The fields marked Operator 1 - 3 are for selecting the arithmetic operation::
 - Addition **+**
 - Subtraction **-**
 - Multiplication **x**
 - Division **:**
 - Modulo **%** (remainder from a division)
 - Exponentiation **^**
- The brackets must be observed in accordance with mathematical rules.
- In the "**differential**" version, these mathematical calculations therefore allow the daily, monthly and annual performance factors to be calculated by dividing the heat amount (thermal energy) by electrical energy and stored on a daily, monthly and annual basis.

Daily values	The stored values are displayed by selecting these buttons
Monthly values	
Yearly values	
Delete history	Selecting this button deletes the stored values after a confirmation prompt.

Output variables

Previous day value	Display of the stored previous day value
--------------------	--

Synchronisation

Function description

This function provides date- and time-specific output variables based on the date and time information of the device.

Digital signals are thereby available which can be used to enable other functions at specific dates or times, for example.

The function can run either once or cyclically.

Input variables

Enable	General enabling of the function (digital value ON/OFF)
--------	---

Parameters

Mode	Available for selection: <i>Hour, Day, Month, Year</i>
Occurrence	Available for selection: <i>Cyclical</i> or <i>Once</i>
Window 1-8	Enter the start and stop times for each time window
<ul style="list-style-type: none"> The Cyclical / Once setting defines whether the set windows should run once or repeatedly (cyclically) when Enable is switched ON. The function allows up to eight date or time windows. Start and end of the window: In the modes Hour and Day the time window starts and ends at the start of the minute specified. In the modes Month and Year the time window starts and ends at 00:00 h on the days specified. 	

Output variable

Synchronisation	Synchronisation status ON/OFF; selection of the output
Summertime	Summertime status ON/OFF
Controller start	Controller start status ON/OFF
<ul style="list-style-type: none"> The Controller start generates a pulse 20 seconds long 40 seconds after the device is switched on or reset. This is used for monitoring controller starts (e.g. after power failures) in the datalogging feature. This requires the interval in datalogging to be set to 10 seconds, however. 	

Timer function

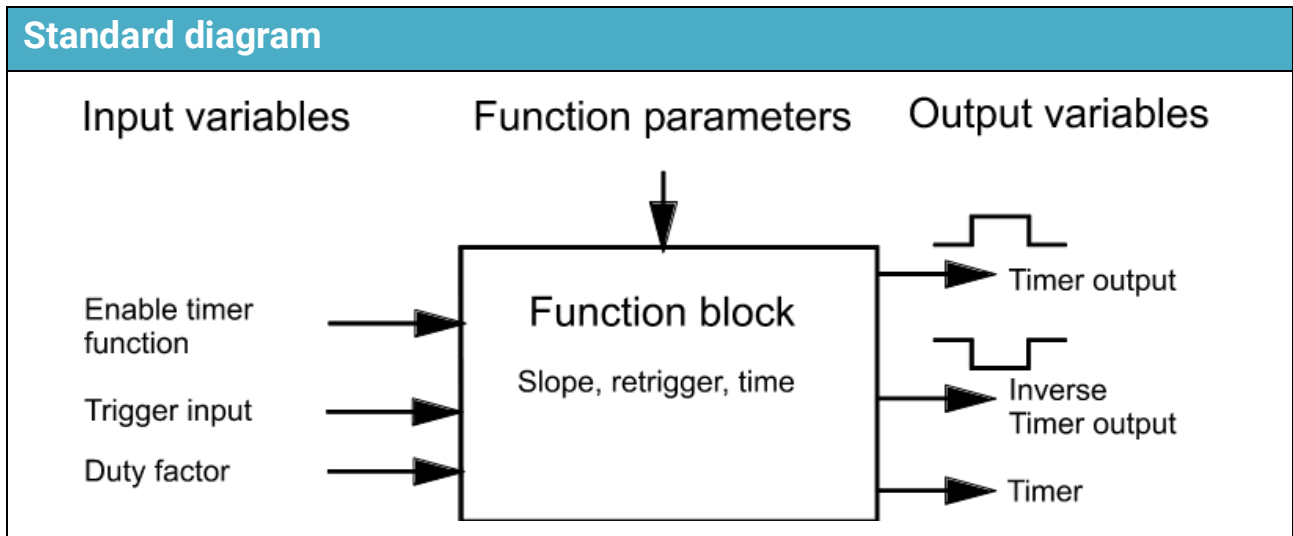

Function description

The Timer function supplies time sequences which switch outputs or which act as the input variables of functions. The runtime of the timer function (= timer runtime) is started by the trigger input or manually from the parameter menu, and runs independently of the time of day. This response is called **triggering**. The timer runtime can be set from 1 second to 366 days.

The "**Duty factor**" input variable allows the specified timer runtime to be modified from 0 to 500%. The timer runtime can thus be influenced via analogue signals and calculation values.

Input variables

Enable	General enabling of the function (digital value ON/OFF)
Trigger input	Digital input signal, ON/OFF, to start the Timer function
Duty factor	Analogue value in % to one decimal place, to modify the timer runtime in this proportion.
Start time	Analogue value for the timer runtime in all modes. If unused, this value is set in the parameters.
Stop time	Analogue value for the OFF time in Astable mode. If unused, this value is set in the parameters.

Parameters	
Mode	Available for selection: <i>Pulse, Run-on time, Delay, Minimum runtime, Blocking time, Astable</i>
Trigger Slope (only for Pulse mode) Retrigger (not shown in Astable mode)	Available for selection: <i>positive, negative, pos./neg.</i> (see Pulse mode) Input Yes, No or, only in pulse mode, Stop (see Retrigger)
Timer runtime (not visible if defined in the input variables or in astable mode)	Enter the timer runtime
ON time OFF time (only displayed instead of timer runtime in astable mode; not visible if defined in the input variables)	ON time in Astable mode OFF time in Astable mode
If enable timer = off Runtime counter	Available for selection: <i>Zero reset, continues running, Paused</i>
Start timer or Stop timer	Manual starting and stopping of the timer function (except for Astable mode) If the timer stops, the runtime counter is set to 0.
<ul style="list-style-type: none"> • If Enable = Off both the timer output and the inverse timer output are switched off. • Action of the runtime counter if enable timer = off: <ul style="list-style-type: none"> • "Zero reset" means that the runtime counter will be set to 0 when Enable is switched OFF. If Enable is switched back ON, the status of the outputs will equate to counter reading 0 (subject to mode). • "continues running" means that the runtime counter will continue running when Enable is switched OFF. If Enable is switched back ON within the timer runtime, the outputs will be switched according to mode, up to the end of the runtime. • "Paused" means that the runtime counter is stopped when Enable is switched OFF. If Enable is switched back ON, the outputs will be switched subject to mode, up to the end of the runtime. • "recharge" means that the runtime counter is charged to the set timer runtime when changing enabling to OFF. If enabling is set back to ON, the timer runs for the full runtime. 	

Retrigger: Retriggering using the example of a positive trigger slope in **Pulse** mode:

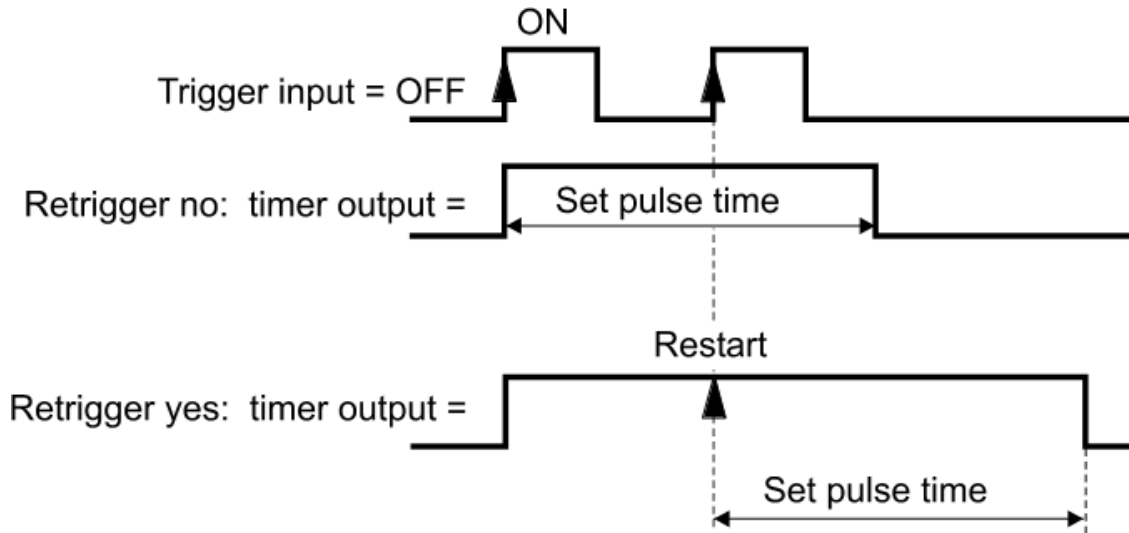

With "**Retrigger No**", the timer runs without change.

With "**Retrigger Yes**", the pulse time is restarted.

With "**Retrigger Stop**" (only in pulse mode), the pulse time is stopped prematurely during retriggering. The **slope** set must either be positive or negative for this mode.

Pulse: If the selected trigger slope occurs, the output for the pulse time switches on. A change in the trigger input status during the pulse time does not change the output status.

Without retriggering: The pulse time runs **irrespective** of the status of the trigger input and does not restart until the selected **trigger slope** occurs **after** the pulse time has elapsed.

With retriggering: When the selected trigger slope occurs, the pulse time will restart even during the currently running ON time.

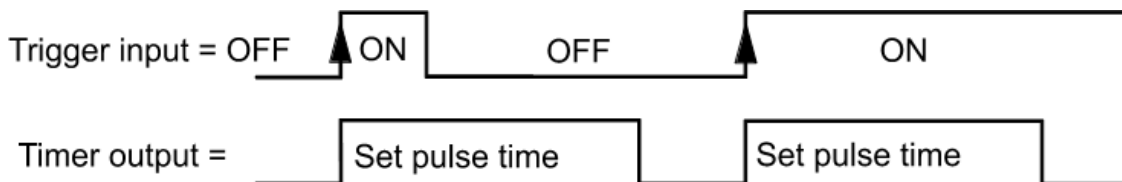

The trigger slope is **positive** if the input status changes from OFF to ON or from switch open to switch closed (= closing). This is shown in the example above.

A change from closed to open (= opening) is a **negative** trigger slope. With trigger slope = **pos/neg** the timer will be started for every change of state at the input.

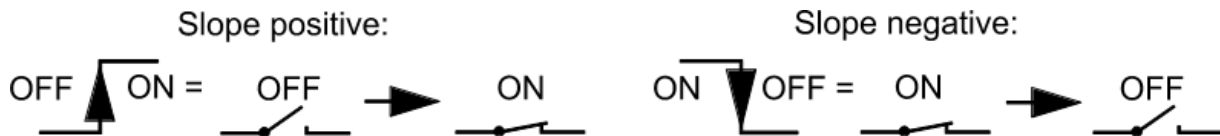

Run-on time: The ON signal at the trigger input switches the output on **immediately**. If the input drops (OFF), the output remains ON for the duration of the run-on time.

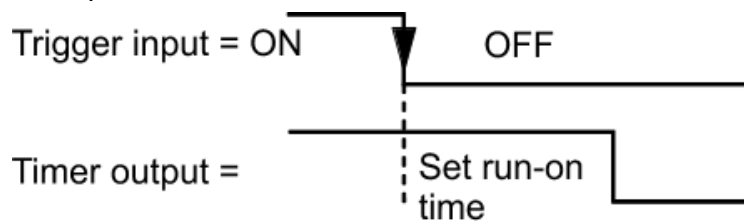

Delay: The ON signal at the trigger input is only passed on to the output when the delay has elapsed. An OFF signal at the trigger input after the delay has elapsed causes the output to be switched off immediately.

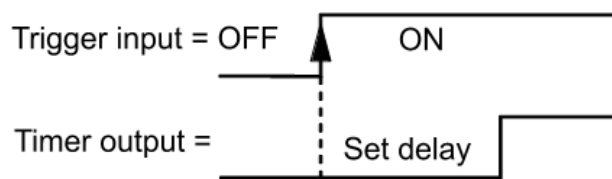

Minimum runtime: The ON signal at the trigger input switches the output on immediately. If the input drops during the minimum runtime (OFF), the output remains switched on anyway until the minimum runtime has elapsed. The output will remain switched on if the trigger input is in status ON when the minimum runtime has elapsed.

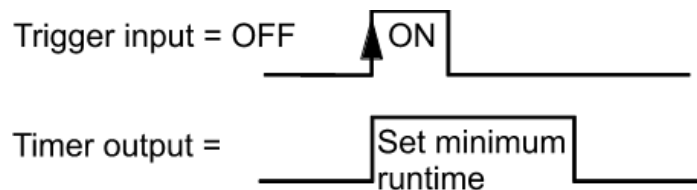

Blocking time: The ON signal at the trigger input only switches the output back on once the blocking time has elapsed **since the end** of the last ON signal.

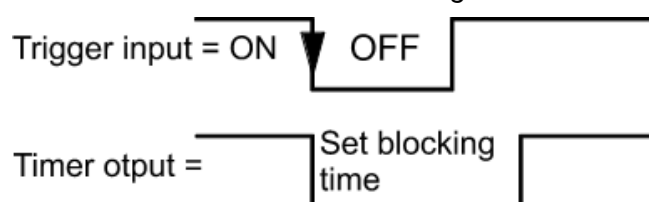

Retrigger = Yes: If the trigger input is switched ON within the blocking time, the blocking time will restart if the trigger input is switched back OFF **within the original blocking time**.

Astable: Entering a start time and an stop time separately produces a clock-pulse generator **without** a trigger input. The mode is started with the start time **immediately** at Enable ON.

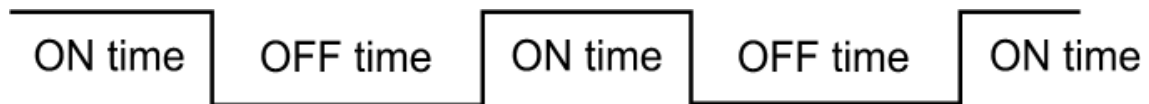

If the **Duty factor** input variable is used as well, **only** the start time will be modified in that proportion.

The setting **stop time = 0** is a special case: The start time then makes up the **entire** period (= **sum** of ON + OFF) and the duty factor establishes the ratio of start time to stop time. A duty factor over 100 % is consequently not useful in this case as the Timer output would remain continuously switched on.

Example: A duty factor of 30 % means the entered start time will be 30 % ON and 70 % OFF.

Output variable

Timer output	Output status ON/OFF; selection of the output
Inverse timer output	Inverse output status ON/OFF; selection of the output
Runtime counter	Display of the timer runtime counting down (or the currently active ON or OFF time, in the case of the astable timer)
<ul style="list-style-type: none"> • If Enable is OFF, the status of both the output and the inverse output will be OFF. • The timer function can also be started and stopped manually from the parameter menu (exception: Astable mode). 	

Comparison function

Function description

The two values **A** and (**B + differential**) are compared, producing the two digital output variables **A > (B + differential)** and **inverse (A > (B + differential))**.

There is also an output variable available for the condition **A = B**.

Input variables

Enable	General enabling of the function (digital value ON/OFF)
Value A	First analogue comparison value
Value B	Second analogue comparison value
<ul style="list-style-type: none"> • Value A cannot be entered by the user. Value B may also be a fixed value. Such a value can be entered by specifying <i>User</i> as the Source. • If sensors are assigned to both values, the result is a simple differential function. • If comparing two sensors, it is recommended to connect the hotter of the two sensors to Value A. • If a room sensor (RAS, RASPT, RAS-PLUS, RAS-F) is used as the source of a value, the transmitted temperature value is applied (without offset values from the operating mode switch). 	

Parameters

Function quantity	A wide range of function quantities are available, which are applied together with their unit and their decimal places.
Diff. on	Start differential for Value B
Diff. off	Stop differential for Value B
<ul style="list-style-type: none"> • In many applications this function will equate to a thermostat. However, the function quantity setting enables a comparison of any numeric values. 	

Output variables

A > (B + diff.)	Status ON if value A > value (B + Diff.); selection of the output
Inverse (A > (B + diff.))	Status ON if value inverse (value A > value (B + diff.)); selection of the output
A = B	Status ON if value A = value B
<ul style="list-style-type: none"> • If Enable is OFF, then all output variables will be OFF. • Both A > (B + diff.) and inverse (A > (B + diff.)) are available as output variables. • When comparing a value captured by a temperature sensor with a fixed threshold value (value B entered under <i>User</i> in the input variables), this equates to a mechanical thermostat with a changeover contact: (A > (B + diff.)) = normally open and inverse (A > (B + diff.)) = normally closed). • If value A = value B applies, then one of the other two output variables will always be set to status ON as well. 	

Heat meter

Standard diagram

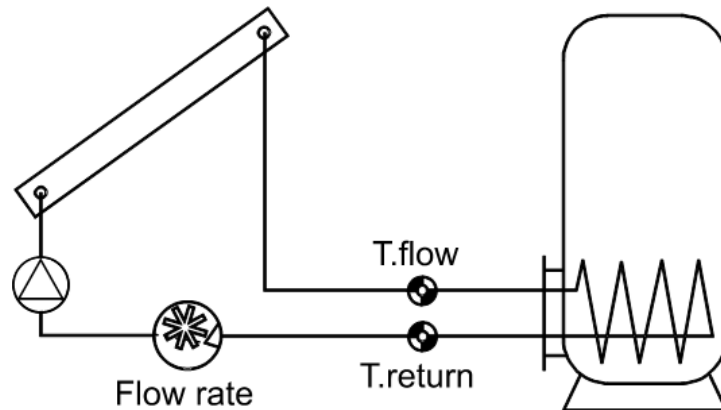

Function description

Calculation of thermal output and metering of thermal energy via the temperature differential $T_{\text{flow}} - T_{\text{return}}$ and the flow rate, and allowing for the antifreeze component in the heat transfer medium.

Input variables

Enable	General enabling of the function (digital value ON/OFF)
Flow temperature	Analogue input signal for the flow temperature
Return temperature	Analogue input signal for the return temperature
Flow rate	Analogue input signal for the flow rate
Meter reset	Digital pulse input signal, ON/OFF, to reset the meter
Specific heat capacity	Optional: Analogue value specifying the heat capacity of the fluid in the measured system
Price / unit	A price per kWh for yield calculations

- The **BFPT1000 5x60MM** sensors fitted in the **KH ball valve** from Technische Alternative are particularly suitable for temperature measurement. The sensors can be removed with little effort for the calibration process.
- With a solar thermal system, the collector sensor can also be used as the flow sensor. For that to be possible, it must be installed in a sensor well at the flow outlet of the collector header. However, the captured amount of heat will then also include the losses in the solar flow line.
- Entering **User** as the source in the **Flow rate** input variable allows a fixed value to be entered as the flow rate instead the flow rate captured by a flow sensor.
- The **meter reset** is carried out by a digital ON pulse or manually in the parameter menu. It will delete **all** meter readings, in other words also those from previous periods. The meter will be blocked as long as this input variable is set to ON. The meter reset also works when Enable = Off.
- **Specific heat capacity:** This optional specification must be entered as a multiple of the unit **0.01 kJ/l*K** as a **dimensionless** number. **Example:** Pure water has a heat capacity of 4.18 kJ/l*K at 20 °C, so a dimensionless value of 418 must be entered for this heat capacity (at 20 °C).
N.B.: The heat capacity of fluids is temperature-dependent. The value entered should therefore be a variable value dependent on the temperature (e.g. from the Curve function).

Parameters	
Frost protection (shown only if the Specific heat capacity input variable is unused)	Specification of the antifreeze component in %
Reversing block	Available for selection: Yes / No
Status Calibration value	Display: Not calibrated or Calibrated Display of the differential T.flow – T.return measured during the calibration process (in Not calibrated status this value must be 0.0 K)
Start calibration	Select to start the calibration process (Note the section Calibration process!)
Delete calib. values	This can be used to undo the calibration. It resets the calibration value to 0.
Delete meter reading	Button for deleting all meter readings
<ul style="list-style-type: none"> • Antifreeze component (frost protection): An average has been calculated from the product specifications of all the major manufacturers and tabulated in relation to the mixing ratio. Under typical conditions this method results in an additional error of no more than one per cent. • Reversing block: Entering No permits negative metering; entering Yes means that the heat meter will only be able to meter positive values. • The tolerance of sensors and measuring device can sometimes lead to substantial errors in the calculation of the differential temperature. The device has a calibration process to compensate this error. • After selecting Start calibration, the user is prompted to confirm. If the calibration was performed by mistake or incorrectly, the result can be undone with Delete calib. values and/or corrected by means of a new calibration. 	
<h3>Calibration process</h3> <p>By simultaneously measuring the same temperature with both sensors, the deviation of the sensors from each other can be ascertained and included as a correction factor in future calculations.</p> <p>The calibration affects only the sensor values in the Heat meter function and is <u>not</u> factored into other functions.</p> <p>During the calibration process, it is very important that both sensors (flow and return) capture the same temperatures. This is achieved by binding the two sensor tips together with a piece of tape or wire. Both sensors should also be fitted now with the lead extensions which will be used later, so that the electrical resistances of the leads are included. If the collector sensor is being used, the required lead length should be estimated and integrated. The sensors must be connected to the two programmed inputs for flow and return and are immersed together in hot water (so that both are exposed to the same temperature).</p> <p>Calibration process:</p> <ol style="list-style-type: none"> 1. Immerse the sensors in the water. 2. Start the calibration process and confirm. Status display: Calibrated. 3. The calibration values displayed in the parameters and the corrected return temperature is included in the output variables. 	

Notes on accuracy

The accuracy of all measured energies and energy flows depends on many factors and is to be subject to closer consideration here.

- PT1000 **class B** temperature sensors have an accuracy of +/- 0.55 K (at 50 °C).
- Errors in temperature capture by the X2 device are typically +/- 0.4 K per channel.

For an assumed spread of 10 K, these two measuring errors result in a **maximum** measuring error between the flow and return of +/- 1.90 K = +/- **19.0 %** for class B and +/- 13.0 % for class A.

- At a lower spread, the percentage measuring error **increases**
- The accuracy of the FTS 4-50DL flow sensor is approx. +/- **1.5 %**

In the **worst case** scenario, the maximum overall measuring error for heat metering therefore equals:

$$1.19 \times 1.015 = 1.208$$

This means heat metering accuracy of +/- **20.8 %** in the **worst case scenario** (at 10 K spread, **without calibrating** the temperature sensors), although all measuring errors would then skew the results to the **same** extent.

Experience has shown that a worst case scenario **never** actually occurs and in an unfavorable scenario, half of this value can be expected. However, even 10.4 % is not justifiable.

After **calibrating** the temperature sensors (see above), the measuring error of the overall temperature measurement reduces to a maximum 0.3 K. Relative to the spread of 10 K as assumed above, this equals a measuring error of 3 %.

The maximum overall measuring error for the performance factor therefore equals:

$$1.03 \times 1.015 = 1.045$$

At a **10 K spread** and **with calibrated** temperature sensors, heat metering accuracy therefore improves for the **worst case scenario** to +/- **4.5 %**.

Output variables	
Output	Display of the current thermal output in kW (to two decimal places)
Corrected return temperature	Display of the return temperature corrected by the calibration process
Differential (T _{flow} -T _{trtn corr})	Display of the current temperature differential between the flow and corrected return temperature, which is critical for the heat meter
Day meter reading	} Meter readings
Prev. day meter reading	
Week meter reading	
Prev. week meter reading	
Month meter reading	
Prev. month meter reading	
Year meter reading	
Prev. year meter reading	
Kilowatt hours total	
Day sum	
Previous day sum	
Week sum	
Prev. week sum	
Month sum	
Prev. month sum	
Year sum	
Prev. year sum	
Sum total	
<ul style="list-style-type: none"> • ATTENTION: The meter readings from the Heat meter function module are saved to the internal memory every hour. Therefore, in the event of a power failure, no more than 1 hour of metering can be lost. • When loading function data, you will be asked whether you want to apply the saved counter readings (see manual Programming Part 1: General information). • If the flow temperature is lower than the return temperature, the meter will count negative energy if the reversing block is set to No. The meter reading will be reduced as a result. • The changeover of the Week meter occurs on Sundays at 24:00 h. 	

Maintenance function

Function description

The maintenance function is designed as a service function for a flue gas inspector and/or as a simple burner circuit for a flue gas emissions test. When the function is started, the burner is switched on with its output as specified, for a specified length of time.

In order to dissipate the heat, the heating circuits set in the parameters are activated **with the maximum permitted flow temperature** (Heat curve sub-menu: T.flow max.). The outputs for the heating circuits therefore do not need to be explicitly defined in the output variables. While the maintenance function is active, the set flow temperature of those heating circuits is displayed as 5 °C and the effective set room temperature as 25 °C. The **Operating level** heating circuit output variable will show **Special mode (0)**, and the operating mode will show **Maintenance (10)**.

The **External switch** and **External button** inputs can be used to activate the Maintenance function via an externally installed switch or pushbutton, respectively (= digital input) or via a digital input from another function.

The Maintenance function can also be started manually from the parameter menu.

Eingangsvariablen

External switch	Digital input signal, ON/OFF, to activate the function
External button	Digital pulse input signal, to activate the function

- **External switch:** The function will be active for as long as the switch is ON, **irrespective** of the total runtime set.
- **External button:** A momentary ON pulse (e.g. from a pushbutton) activates the function for the total runtime selected. A subsequent ON pulse **during** the runtime will disable it again (early termination).

Parameters

No. of functions included Included functions Display of the heating circuits	Enter the number of heating circuit functions included Sub-menu: Select the heating circuit functions to be activated by the Maintenance function.
Total runtime	Runtime of the function when activated by the external button or from within the function status screen
Generator output	Specify the heat generator output during the Maintenance function as % to one decimal place
Start function or Stop function	Manual starting and stopping of the maintenance function

- The function makes the thermal output of the heat generator available as an output variable. The generator output issued by the Maintenance function is **dominant**. Consequently, no other analogue signal (e.g. from DHW demand) will be permitted at the analogue output during maintenance work. Digital signals to the analogue output, however, will not be overwritten by the Maintenance function.
Scaling of the analogue output: $0 = 0.00 \text{ V} / 1000 = 10.00 \text{ V}$
- Once the heat generator demand is switched off (function is stopped), the included heating circuits remain active for a further **three minutes** in Special mode / Maintenance in order to transfer the residual heat from the boiler. Only then does the heating circuit return to the previous operating mode.

Output variables	
Generator demand	Demand status, ON/OFF; selection of the output
Generator output	Display of the current output value; selection of the analogue output
Runtime counter	Display of a countdown of the Activation time of the Maintenance function (display remains 0 if started via the external switch)

Conservatory function

Standard diagram

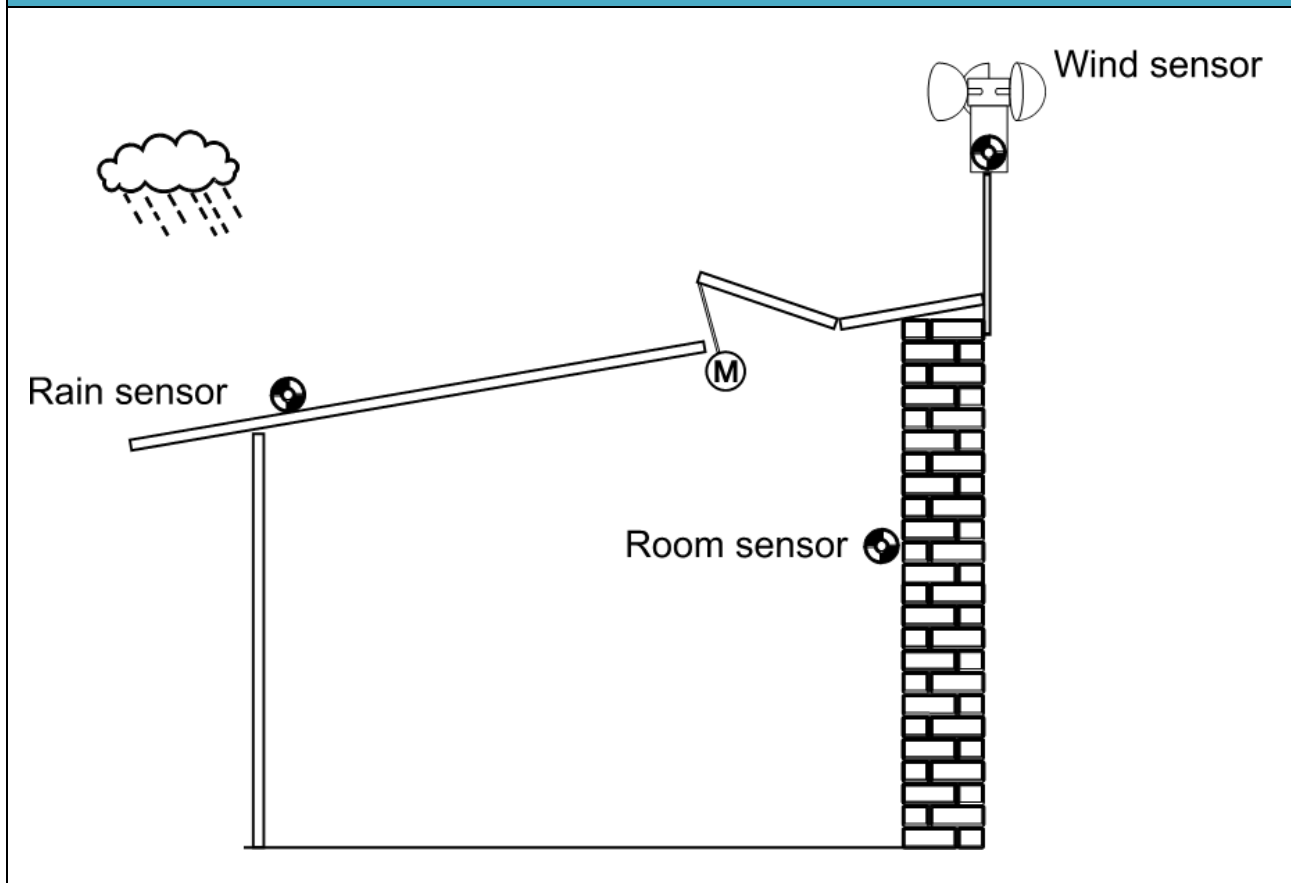

Function description

The Conservatory function opens a window to let air out when the room temperature in the conservatory exceeds a threshold. Optionally, a wind and/or rain sensor can be used to trigger closing of the window independent of the room temperature.

It is possible for manual operation to override the automatic temperature control. The safety shutdown via the wind or rain sensor remains effective in manual mode as well.

Input variables	
Enable	General enabling of the function (digital signal ON/OFF)
Enable auto mode	Enabling automatic mode (digital signal ON/OFF)
Open window	Digital input signal, ON/OFF
Close window	Digital input signal, ON/OFF
Fully open window	Digital input signal ON (pulse)
Fully close window	Digital input signal ON (pulse)
Trigger auto mode	Digital input signal ON (pulse)
Conservatory temperature	Analogue input signal for the conservatory temperature (room temperature)
Conservatory set temperature	Analogue value specifying the set temperature
Rain sensor	Optional: Analogue input signal from a rain sensor (dimensionless without decimal places) e.g. RES type from Technische Alternative
Wind speed	Optional: Analogue input signal from a wind sensor in km/h without decimal places, e.g. WIS01 type from Technische Alternative
Offset conservatory set temperature	Analogue value specifying an offset for the set conservatory temperature
Switching to auto mode at	Time at which manual mode switches back to auto mode or a switch is made to auto mode with a digital ON pulse or switching is deactivated through a digital OFF signal
<ul style="list-style-type: none"> • When Enable auto mode is switched OFF, the window will be opened, closed or remain unchanged, according to the Closing conditions. Operation is then only possible in manual mode, although the safety shutdown via wind or rain sensor remains active. • Room sensors RAS, RAS PT, RAS-PLUS and RAS-F can be used to generate the input signal for the conservatory temperature. • The sensors from Technische Alternative (types RES and WIS01) can be used to generate the input signals for the rain and wind sensors). • The input variables Open window and Close window require digital switching signals. The function terminates auto mode and opens/closes the window for as long as the input signal is ON. If the Long click time (parameter) is exceeded or a double click is performed within the Double click time, the window is opened or closed fully. • If in manual mode Open window and Close window are activated simultaneously, the function switches from manual mode to auto mode. We therefore recommend the use of blind push-buttons with no interlock between OPEN and CLOSE. • The input variables Fully open window and Fully close window are activated by pulse signals. This function terminates auto mode. • Trigger auto mode activates a return from manual mode to auto mode. The signal does not take effect until the window reaches the end position specified by the previous manual operation. • Switching to auto mode: Switching is deactivated if a digital OFF signal is present. 	

Parameters	
<p>Conservatory temperature</p> <p>Set temperature</p> <p>Diff. on</p> <p>Diff. off</p>	<p>Display of the set temperature (input variable)</p> <p>Start differential for the set temperature</p> <p>Stop differential for the set temperature</p>
<p>Auto mode</p> <p>Motor runtime per action</p> <p>Interval time</p>	<p>Motor OPEN or CLOSE runtime per action</p> <p>Interval time between the starts of two motor runtimes</p>
<p>Manual mode</p> <p>Long click time</p> <p>Double click time</p>	<p>If the long click time is exceeded for the input signals Open window or Close window the window will be opened or closed fully (enter value = 0 to deactivate).</p> <p>If two pulses are received within the double click time on the input variables Open window or Close window the window will be opened or closed fully (enter value = 0 to deactivate).</p> <p>The closing or opening of the window can be terminated early by a pulse on the opposite command in each case.</p>
<p>Closing conditions</p>	<p>Setting of the closing conditions if a rain and/or wind sensor is used or if an Enable signal = Off (see Closing conditions sub-chapter)</p>
<ul style="list-style-type: none"> • When the window is opened or closed due to the room temperature, it will only be opened or closed for the duration of the set Motor runtime per action. • The Interval time starts at the start of the motor runtime. The next motor runtime cannot start until the interval time has elapsed. It is therefore advisable to set the interval time to be longer than the motor runtime per action. The stoppage time allows the room temperature to adjust to the set temperature in accordance with the window position. The next motor runtime starts if the adjustment is insufficient. • The Motor runtime per action is ignored in manual mode. • The Motor runtime per action is likewise ignored when the window is closed due to the closing conditions. The window receives a closing command for the duration of twice the runtime set at the output pair. 	

Parameters in Closing conditions sub-menu

The parameters for the rain and wind sensors are shown only if those sensors have been defined in the input variables.

if enable = off	Select the action when Enable = Off Available for selection: Window <i>Open, Close, Unchanged</i>
if enable auto mode = off	Select the action upon changeover to Enable auto mode = Off Available for selection: Window <i>Open, Close, Unchanged</i>
Rain sensor Rain threshold Diff. on Diff. off Blocking time	Analogue value specifying the rain threshold (see comments) Start differential for rain threshold Stop differential for rain threshold Enter the blocking time after closing by the rain sensor
Wind sensor Max. wind speed Diff. on Diff. off Blocking time	Analogue value specifying the maximum permitted wind speed in km/h Start differential for the maximum wind speed Stop differential for the maximum wind speed Enter the blocking time after closing by the wind sensor
<ul style="list-style-type: none"> The rain sensor returns a numeric value to the input variable in accordance with the moisture level detected. The value is dimensionless (with no unit or decimal places). The dry value is >700. As the dry value can be lessened by dirt on the sensor, the rain threshold should be set to approx. 300. The RES rain sensor from Technische Alternative meets these requirements. If closing is triggered by the rain or wind sensor, re-opening cannot occur until the end of twice the runtime (= interval time) or the end of the blocking time, whichever of these time settings is longer. The blocking times prevent a quick succession of closing and opening commands for the window motor in the event of fluctuating values (e.g. gusts of wind). If Enable auto mode is switched off, the window drive will act according to the set closing condition. After that the window can be operated in manual mode. If Enable auto mode is switched on again, the function remains in manual mode until an On pulse on Trigger auto mode, simultaneous actuation of Open window and Close window, or until changeover to automatic mode occurs at the time set under Switching to auto mode at. 	

Output variables	
Open/close window	Window drive status OPEN/OFF/CLOSE; selection of the output pair for the window drive
Window 0-100%	A percentage value to one decimal place, for control of a window drive with 0-10 V input via an analogue output
Effective conservatory set temp.	Display of the current set conservatory temperature including offset value
Auto mode status	Status ON if function is in auto mode
Remaining runtime ctr	Display of a countdown of the remaining double runtime set at the output pair
Interval timer	Display of a countdown of the interval time
Window open	Status ON when the window is fully open (at end of remaining runtime)
Window closed	Status ON when the window is fully closed (at end of remaining runtime)
No rain	Status ON if the window drive has been enabled by the rain sensor and the remaining runtime has elapsed.
Rain block counter	Display of a countdown of the blocking time in seconds
Wind speed < max.	Status ON if the window drive has been enabled by the wind sensor and the remaining runtime has elapsed.
Wind block counter	Display of a countdown of the blocking time in seconds
<ul style="list-style-type: none"> Once the accumulated runtime of the window has reached twice the runtime set at the output pair, the output will no longer be activated in that direction. The remaining runtime counter will display 0, and the Window open or Window closed display will have the status ON. If shutdown is activated by the wind or rain sensor, the interval time changes to twice the runtime. Opening the window when the shutdown condition has ended is not possible until the window is completely closed (remaining runtime counter = 0, window closed status = ON) and the blocking time has elapsed. Window drive 0 - 100 %: Scaling of the analogue output: 0 = 0.00 V / 1000 = 10.00 V If Enable = OFF, then 30 °C will be issued as the effective set conservatory temperature. A changeover from manual to auto mode can only be brought about by an On pulse on Trigger auto mode, simultaneous actuation of Open window and Close window or by the time exceeding the time set in Switching to auto mode at. 	

Meter / Counter

Function description

The Meter / Counter function can be used as an hours run meter or as a pulse counter. The pulse counter mode also allows liters (e.g. **water consumption**), energy (e.g. **electrical energy**) or cubic meters (e.g. **gas consumption**) to be metered with the aid of input pulses.

Input variables

Enable	General enabling of the function (digital input signal ON/OFF)
Meter reset	Digital pulse input signal, ON/OFF, to reset the meter
Price / unit	A price per unit for yield calculations
Input 1 – 6	Digital input signal, ON/OFF (hours run meter) or pulse signals (pulse counter)

- The **meter reset** is carried out by a digital ON pulse or manually in the parameter menu. It will delete **all** meter readings, in other words also those from previous periods. The meter will be blocked as long as this input variable is set to ON. The meter reset also works when Enable = Off.
- Pulse signals may have up to 10 Hz at inputs 1-14 (50 ms pulse duration, 50 ms pause), and up to 20 Hz at inputs 15 and 16 (25 ms pulse duration, 25 ms pause). The inputs 15 and 16 can therefore be used without restriction for **S0 signals** from meters/counters.
- **Price/Unit:** Unit exceptions:
For the hours run meter, the unit is one hour (3600 seconds)
For the pulse counter / Energy unit, the unit is 0.1 kWh

Parameters for hours run meter

Mode	Available for selection: Hours run meter
Delete meter reading	Button for deleting all meter readings

- If more than one input is listed in the input variables, the hours will be metered as long as at least one input is set to ON.

Parameter Impulszähler

Mode	Available for selection: Pulse counter
Unit	Available for selection: Pulses, Liter, Energy, Cubic meter
Divisor	Enter: number of pulses per unit
Factor	Enter: number of units per pulse
Input count direction 1 - 6	Define the counting direction for each pulse input Available for selection: positive / negative
Delete meter reading	Button for deleting all meter readings

- In the pulse counter mode, **all** inputs are included in the count.
- With the Energy unit (kWh) one pulse equates to 0.1 kWh (if divisor and factor are 1).
- **Count direction:** The count direction can be defined for each input. Inputs can thus also reduce the counter reading, and differential results can be produced. This also means that the counter reading can have a negative value.
- If pulse signals arrive at different inputs **simultaneously, every** pulse will be counted according to its count direction.

Output variables	
Day meter reading	} Meter readings
Prev. day meter reading	
Week meter reading	
Prev. week meter reading	
Month meter reading	
Prev. month meter reading	
Year meter reading	
Prev. year meter reading	
Total meter reading	
Day sum	} Display of yield in the set currency
Previous day sum	
Week sum	
Prev. week sum	
Month sum	
Prev. month sum	
Year sum	
Prev. year sum	
Sum total	
<ul style="list-style-type: none"> • ATTENTION: The meter readings from the Meter / Counter function module are saved to the internal memory every hour. Therefore, in the event of a power failure, no more than 1 hour of metering can be lost. • When loading function data, you will be asked whether you want to apply the saved counter readings (see manual Programming Part 1: General information). • The changeover of the Week meter occurs on Sundays at 24:00 h. 	

DHW circulation

Standard diagram

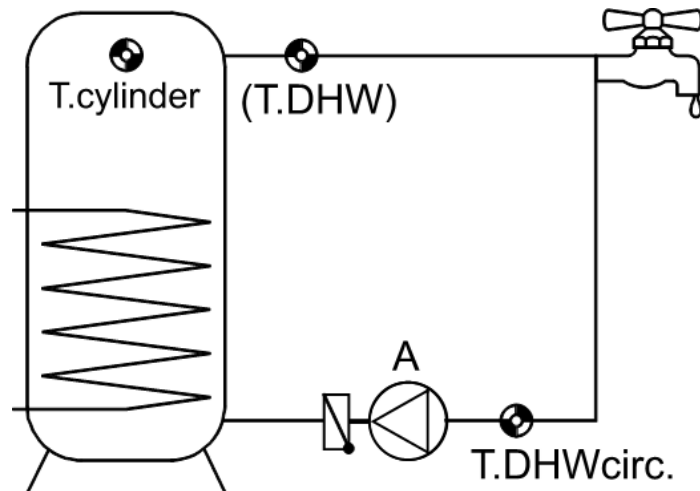

Function description

Time control: The DHW circulation pump **A** is switched on via the time condition status and remains on until the return sensor **T.DHWcirc.** reaches its set temperature. The sensor **T.DHW** is **not** required. Outside the time window, an effective set temperature of 5.0 °C is issued for the DHW circulation return, thus switching the pump off permanently.

Pulse control: A sudden change in temperature at a **T.DHW** temperature sensor or a change in the status of a **T.DHW** flow switch causes the DHW circulation pump to be switched on for a specified maximum runtime.

Combination of time and pulse control: Time control applies within the time window, pulse control applies outside it.

The optional cylinder sensor **T.cylinder** can be used to implement **mixing protection** for all modes

Input variables

Enable	General enabling of the function (digital input signal ON/OFF)
Return temperature	Analogue input signal for the return temperature T.DHWcirc. on the DHW circulation line
DHW temp.	Analogue input signal for the DHW temperature T.DHW or a digital input signal from a flow switch (only required for Pulse mode)
Time condition status	Digital input signal, ON/OFF (e.g. from the Time switch function)
DHW circulation set temperature	Analogue value specifying the DHW circulation set temperature T.DHWcirc. set
Cylinder temperature	Optional: Analogue input signal for the cylinder temperature T.cylinder (only required for Mixing protection)

Parameters	
Operating mode	Available for selection: <i>Time, Pulse, Time/pulse</i> (Pulse and Time/pulse only possible if a sensor for T.DHW has been defined.)
T.DHW circ. return T.DHWcirc. set Diff. on Diff. off	Display of the DHW circulation set temperature as per the input variable Start differential for T.DHWcirc. set or for the effective set value resulting from mixing protection Stop differential for T.DHWcirc. set or for the effective set value
Pulse mode (shown only with operating mode Pulse and Time/pulse and defined sensor T.DHW) dDiff. on Runtime Pause time	A temperature change of at least x K / second at sensor T.DHW starts the pump. Maximum runtime per interval Minimum time between two pump runs
Mixing protection (shown only with defined cylinder sensor T.cylinder) T.cylinder min. Mixing differential	DHW circulation will not be permitted below this cylinder temperature (fixed hysteresis = 3 K) Minimum differential between T.cylinder and effective DHW circulation return temperature
<ul style="list-style-type: none"> For hygienic, on-demand DHW heating (in a freshwater module), the Pulse mode can be utilised as an alternative control method with the aid of the DHW sensor T.DHW. This requires an ultra-fast temperature sensor (MSP... = special accessory) at the DHW outlet of the plate heat exchanger. T.DHW is used to control both the heating of the water and its circulation. When a tap is opened briefly, the temperature at T.DHW changes. If an adjustable jump in temperature is captured at T.DHW within a second, the controller will switch on the DHW circulation pump. The pump stops either at the end of the set runtime or when the set value is exceeded at T.DHWcirc., whichever occurs first. Hot water is thus supplied to the draw-off point within a short time without the tap being open continuously. The Pulse mode is very reliable for the control of hygienic, on-demand DHW heating when used with an ultra-fast sensor. If standard sensors are used, the temperature change is detected much more slowly. Instead of this temperature capture, a flow switch (STS01DC = special accessory) can also be used for the DHW circulation function. The sudden, jump-like digital signal of the flow switch at the DHW temp. input variable causes the DHW circulation pump to be switched on immediately (no retriggering during the runtime or pause time). Mixing protection stage 1: The DHW circulation function is blocked below the minimum cylinder temperature T.cylinder min. so that the running pump does not cause the stratified residual energy in the cylinder to be lost. Mixing protection stage 2: To prevent mixing through the cylinder content above the T.cylinder min. threshold, the differential between the cylinder temperature and the return temperature is measured (mixing differential). If the cylinder temperature less the Mixing differential is lower than the set return temperature T.DHWcirc. set, that value will apply as the new set temperature for DHW circulation return (output variable: Effective set circ. rtn temp). Mixing protection is disabled if there is no cylinder sensor T.cylinder. 	

Output variables	
Effective set circ. rtn temp	Effective set temperature, DHW circulation return (subject to mixing protection and the time window)
Status DHW circ.	DHW circulation pump status ON/OFF; selection of the output
Runtime counter	Display of a countdown of the runtime (pulse mode)
Pause time	Display of a countdown of the pause time (pulse mode)
T.cylinder > T.cyl. min.	Status ON if the cylinder temperature T.cylinder is higher than the minimum threshold T.cyl. min. (mixing protection stage 1) and if there is no cylinder sensor defined.
T.circ.rtn < T.circ. eff. set	Status ON if the DHW circulation return temperature is lower than the effective set temperature.

Subject to technical modifications.

© 2021

Impressum

Diese Bedienungsanleitung ist urheberrechtlich geschützt.

Eine Verwendung außerhalb des Urheberrechts bedarf der Zustimmung der Firma Technische Alternative RT GmbH. Dies gilt insbesondere für Vervielfältigungen, Übersetzungen und elektronische Medien.

Technische Alternative RT GmbH

A-3872 Amaliendorf, Langestraße 124

Tel.: +43 (0)2862 53635

Fax +43 (0)2862 53635 7

E-Mail: mail@ta.co.at

-- www.ta.co.at --



©2021